

2015 Salt Lake County Integrated Watershed Plan

**Update to the
2009 Salt Lake Countywide Water Quality Stewardship Plan**

Published September 2016

Revised September 2017

Prepared By:

Salt Lake County
Watershed Planning & Restoration
2001 South State Street, Suite N3-120
Salt Lake City, UT 84190

HDR Engineering, Inc.
2825 East Cottonwood Parkway, Suite 200
Salt Lake City, UT 84121

This page is intentionally blank.

ACKNOWLEDGEMENTS

Water quality and watershed issues are complex, multi-faceted, and at times contradictory. Establishing and maintaining effective stewardship requires cooperation between local municipal governments, stakeholder groups, and various management and regulatory agencies. It is only with continued cooperation that we will collectively improve water quality and watershed health in Salt Lake County.

Our thanks go to the numerous individuals and organizations that supported and contributed to the development of this plan as critical thinkers, technical experts, and reviewers. In particular, we thank Mayor Ben McAdams and Salt Lake County Council for their continued support of environmental stewardship and integrated watershed planning.

Salt Lake County

Mayor Ben McAdams Administration, Flood Control Engineering, Township Services, Parks and Recreation, Salt Lake County Health Department

Salt Lake County Council

Jim Bradley, Arlyn Bradshaw, Max Burdick, Steve DeBry, Sam Granato, Michael Jensen, Richard Snelgrove, Jenny Wilson, Aimee Winder Newton

Municipal Governments

Town of Alta, Bluffdale City, Cottonwood Heights, Draper City, Herriman City, Holladay City, Midvale City, Murray City, Riverton City, Salt Lake City, Sandy City, South Jordan City, South Salt Lake City, Taylorsville City, West Jordan City, West Valley City

State of Utah

Utah Divisions of Drinking Water, Sovereign Lands, Water Quality, Water Rights, Water Resources, Wildlife Resources; Utah Department of Transportation

Federal Government

Natural Resource Conservation Service, US Army Corps of Engineers, US Environmental Protection Agency, US Fish and Wildlife Service, US Forest Service

Other Key Stakeholders and Advisory Groups

Jordan River Watershed Council, Jordan River Commission, Local Non-Governmental Organizations, Publicly Owned Treatment Works, Stormwater Coalition, Utah Association of Conservation Districts, University of Utah, Utah Lake Commission, Wasatch Front Regional Council

This page is intentionally blank.

CONTENTS

1.0	Introduction	1
1.1	Area-Wide Water Quality Planning Authority.....	1
1.2	2009 Plan Background	2
1.3	Plan Purpose.....	3
1.4	Organization of This Document	3
2.0	Six-Year Evaluation.....	5
2.1	High Priority Implementation Tasks from the 2009 Plan	5
2.2	Summary of Accomplishments	7
2.3	Summary of Implementation Process	13
3.0	Watershed Characterization	15
3.1	General Watershed Information	15
	Watershed Area & Regional Context.....	15
	Streams and Rivers.....	16
	Watershed and Sub-watershed Boundaries	18
	Regulatory Designations	21
	Municipalities and Townships	30
	Other Jurisdictions and Land-Management Agencies	32
3.2	Population and Land Use	33
	Land Use.....	38
3.3	Social and Recreation Functions	45
3.4	Environmental Justice Populations and Water Quality.....	50
3.5	Water Quality.....	57
	2009 Plan Summary of Water Quality Conditions	57
	Introduction to Water Quality Data Collection Programs	57
	Salt Lake County’s Sampling Program.....	60
	Jordan River Sampling by UDWQ	77
	Summary	79
3.6	Habitat.....	80
	2009 Plan and Stream Function Index.....	80
	Physical Habitat Data Collection and Analysis	80
	Summary	86
3.7	Climate Change.....	86
	2009 Plan Summary.....	86
	Local Climate Conditions Predicted by Global Climate Model Simulations	87
	Other Relevant Local and Regional Studies	94
	Summary of Climate Model Scenarios.....	96
	Climate Effects on Watershed Functions	97
3.8	Water and Energy.....	98

	How We Use Energy for Water	98
	How We Use Water for Energy	99
	Opportunities	102
3.9	References	104
	General Watershed, Population, and Land Use References	104
	Environmental Justice References	104
	Water Quality References	105
	Habitat References	105
	Climate Change References	106
	Water and Energy References	106
4.0	Watershed Planning Elements.....	109
4.1	Stormwater Discharges	109
	2009 Plan Summary.....	109
	Regulatory Framework.....	110
	Industrial Stormwater Discharges	110
	Municipal Stormwater Discharges	111
	Summary	114
4.2	Water Supply.....	114
	2009 Plan Summary.....	114
	Regulatory Framework.....	115
	Water Supply Systems	116
	Existing and Future Water Supply Sources.....	118
4.3	Municipal & Industrial Wastewater Discharges	126
	2009 Plan Summary.....	126
	Existing Municipal Wastewater Treatment Facilities.....	126
	Biosolids	128
	Reuse and Gray Water.....	128
	Regulatory Trends.....	128
	TMDL Studies and Implementation	129
	New and Expanded Municipal Treatment Facilities	130
4.4	Nonpoint Source Pollution Discharges – On-site Wastewater Disposal Systems	131
	2009 Plan Summary.....	131
	Existing Septic Systems	132
	TMDL Studies and Implementation	132
	Summary	132
4.5	Pilot Studies.....	133
	Debris Basin Retrofit Pilot Study.....	133
	Instream Flow in Little Cottonwood Creek Pilot Study.....	148
4.6	References	156
5.0	Implementation	159
5.1	Summary of 2009 Plan	159
5.2	Watershed Stressors	159
5.3	Sub-watershed Characteristics.....	160
5.4	Watershed Management Practices.....	165
5.5	Guiding Policies.....	166

5.6	Priority Implementation Recommendations.....	166
	Public and Stakeholder Involvement Plan	168
5.7	Monitoring	171
	Existing Monitoring Efforts.....	171
	Future Monitoring Efforts	172
5.8	Procedural.....	173
	Plan Approval Process.....	173
	Plan Update Process	174
	Plan Amendment Process.....	175
5.9	References.....	177

Tables

Table 2-1.	Priority Implementation Tasks from the 2009 Plan	6
Table 2-2.	Project Implementation Summary, 2009–2015	9
Table 3-1.	Watersheds and Sub-watersheds in Salt Lake County.....	20
Table 3-2.	Designated Beneficial Uses of Utah Waters	22
Table 3-3.	Water Quality Assessment Categories and Subcategories	24
Table 3-4.	Impaired Waterbodies in Salt Lake County (2014).....	27
Table 3-5.	Category 1 High-Quality Waters in Salt Lake County	29
Table 3-6.	General Characteristics of Local Jurisdictions in Salt Lake County	31
Table 3-7.	Salt Lake County Sub-watershed Population Change (2011–2040)	35
Table 3-8.	Projected Changes in Land Use in Salt Lake County (2011–2040).....	39
Table 3-9.	Impervious Surface Area Factor Per Land Use Category.....	42
Table 3-10.	Salt Lake County Water Quality Period of Record for Selected Parameters	59
Table 3-11.	Jordan River Water Quality Monitoring Locations.....	78
Table 3-12.	Sub-groups and Metrics for the Habitat Functional Group	81
Table 3-13.	Physical Habitat Index Metrics and Targets	84
Table 3-14.	Habitat, Stream Channel, and Riparian Corridor Index Scores (2013)	85
Table 3-15.	Water and Energy Opportunities	103
Table 4-1.	Salt Lake County Stormwater Discharge Event Mean Concentrations (2009–2013)	113
Table 4-2.	Estimated Pollutant Load Rates in Unincorporated Salt Lake County	114
Table 4-3.	Public Water Suppliers (2014)	116
Table 4-4.	Water Sources and Volume Used by JWCD Customers (2014)	118
Table 4-5.	Existing Water Treatment Plants and Capacities.....	118
Table 4-6.	Salt Lake City Existing and Future Sources.....	119
Table 4-7.	MWDSLS Existing (2014) and Future (2055) Water Sources	122
Table 4-8.	JWCD Existing and Future Sources	123
Table 4-9.	Existing Municipal Treatment Facility Description and Capacities.....	127
Table 4-10.	Municipal Treatment Facility Planned Improvements	129
Table 4-11.	Sediment Removed from Debris Basins in Salt Lake County (2011–2013)	136

Table 4-12. Stormwater Pollutant Event Mean Concentrations (EMCs) and Stormwater Pollutant Loads in the Spencer’s Pond Debris Basin (2013).....	137
Table 4-13. Snowmelt and Non-snowmelt Maximum, Average, and Minimum Stream Flows at Gage Site 320	140
Table 4-14. Stormwater Pollutant-Removal Efficiencies for Swales	146
Table 4-15. Estimates of Stormwater Pollutant Loads Removed by the Proposed Vegetated Swale.....	146
Table 4-16. Estimated Design and Construction Costs for the Spencer’s Pond Debris Basin Retrofit.....	147
Table 4-17. Measured Flows in Little Cottonwood Creek (2015).....	153
Table 4-18. Model Simulation Results for Little Cottonwood Creek.....	154
Table 5-1. Watershed Function Stressors	160
Table 5-2. Sub-watershed Characteristics and Conditions – 2015 Plan Update	162
Table 5-3. Structural and Nonstructural Watershed Management Practices	165
Table 5-4. Public and Stakeholder Involvement Plan	170
Table 5-5. Entities Conducting Water Quality and Watershed Data Collection	171
Table 5-6. Watershed Function Parameters	172

Figures

Figure 2-1. Stream Restoration Locations, 2009–2015.....	8
Figure 2-2. Typical Jordan River Emergent Bench Design.....	9
Figure 3-1. Utah Hydrologic Basins.....	16
Figure 3-2. Salt Lake County Setting	17
Figure 3-3. Watersheds and Sub-watersheds in Salt Lake County	19
Figure 3-4. Designated Beneficial-Use Classifications of Waters in Salt Lake County	23
Figure 3-5. DWQ Assessment of Stream and River Segments.....	25
Figure 3-6. Municipalities and Townships in Salt Lake County.....	30
Figure 3-7. Projected Change in Population Density by Sub-watershed (2011–2040)	36
Figure 3-8. Projected Percent Change in Population Density by Sub-watershed (2011–2040)	37
Figure 3-9. Existing Land Uses in Salt Lake County (2011)	40
Figure 3-10. Projected Future Land Uses in Salt Lake County (2040).....	41
Figure 3-11. Change in Impervious Surface Area by Sub-watershed (2011–2040)	44
Figure 3-12. Projected Decrease in Open-Space Area by Sub-watershed (2011–2040)	49
Figure 3-13. Distribution of People Living in Poverty in Salt Lake County by Sub-watershed	53
Figure 3-14. Distribution of Racial Minorities in Salt Lake County by Sub-watershed	54
Figure 3-15. Distribution of People Who Identify as Hispanic or Latino/Latina, Regardless of Race by Sub-watershed.....	55
Figure 3-16. Water Quality Locations Sampled by the County and UDWQ	58
Figure 3-17. Average Monthly TDS for Little and Big Cottonwood Creeks (2010–2014).....	62
Figure 3-18. Average Monthly TDS for Mill Creek (2010–2014).....	63
Figure 3-19. Average Monthly TDS for City, Red Butte, Emigration and Lower Parley’s Creeks (2010–2014)	63
Figure 3-20. Average Monthly TDS for Upper Parley’s Creek (2010–2014)	64

Figure 3-21. Average Monthly TDS for Bingham, Rose, and Midas/Butterfield Creeks (2010–2014) 64

Figure 3-22. Average pH for Streams in the Northeastern County Area (2010–2014) 66

Figure 3-23. Average pH for Streams in the Southeastern County Area (2010–2014)..... 66

Figure 3-24. Average pH for Streams in the Southwestern County Area (2010–2014)..... 66

Figure 3-25. Average DO for Streams in Northeastern Salt Lake County (2010–2014) 68

Figure 3-26. Average DO for Streams in Southeastern Salt Lake County (2010–2014) 68

Figure 3-27. Average DO for Streams in Southwestern Salt Lake County (2010–2014)..... 68

Figure 3-28. Average Monthly Temperature for Streams in the Northeastern County Area (2010–2014) 70

Figure 3-29. Average Monthly Temperature for Streams in the Southeastern County Area (2010–2014)..... 70

Figure 3-30. Average Monthly Temperature for Streams in the Southwestern County Area (2010–2014)..... 70

Figure 3-31. Average Monthly *E. coli* for Streams in the Northeastern County Area (2010–2014)..... 72

Figure 3-32. Average Monthly *E. coli* for Streams in the Southeastern County Area (2010–2014) 72

Figure 3-33. Average Monthly *E. coli* for Streams in the Southwestern County Area (2010–2014) 72

Figure 3-34. Average *E. coli* Data for Various Monitoring Locations along Emigration Creek (2010–2014) 73

Figure 3-35. Average *E. coli* Data for Various Monitoring Locations along Parley’s Creek (2010–2014)..... 73

Figure 3-36. Average *E. coli* Data for Various Monitoring Locations along Mill Creek (2010–2014)..... 74

Figure 3-37. Average Simpson’s Diversity Index for Streams in the Northeastern County Area (2009, 2011, 2012, and 2013)..... 76

Figure 3-38. Average Simpson’s Diversity Index for Streams in the Southeastern County Area (2009, 2011, 2012, and 2013)..... 76

Figure 3-39. Average Simpson’s Diversity Index for Streams in the Southwestern County Area (2009, 2011, 2012, and 2013)..... 77

Figure 3-40. Stream Type Delineative Criteria..... 82

Figure 3-41. Habitat and Reference Reach Sites for the 2013 Physical Habitat Data Collection 83

Figure 3-42. Model Simulation Results for Change in Monthly Temperature at Airport and Mountain Locations..... 88

Figure 3-43. Model Simulation Results for Change in Monthly Precipitation at Airport and Mountain Locations..... 89

Figure 3-44. Model Simulation Results for Change in Monthly Runoff at Airport and Mountain Locations..... 90

Figure 3-45. Simulated Effect for Average Monthly Runoff Hydrograph – Airport Location with the Dry Scenario 92

Figure 3-46. Simulated Effect for Average Monthly Runoff Hydrograph – Airport Location with the Wet Scenario..... 93

Figure 3-47. Simulated Effect for Average Monthly Runoff Hydrograph – Mountain Location with the Dry Scenario 93

Figure 3-48. Simulated Effect for Average Monthly Runoff Hydrograph – Mountain Location with the Wet Scenario..... 94

Figure 3-49. Utah Energy Production (2012) 100

Figure 4-1. Active Industrial Stormwater Discharge Permits Regulated by UDWQ 111

Figure 4-2. MWDSLS Future Water Supply Plan 121

Figure 4-3. JVVCD Future Water Supply Plan 125

Figure 4-4. Municipal Wastewater Treatment Facilities..... 127

Figure 4-5. Debris Basins Operated by Salt Lake County’s Flood Control Engineering Division..... 134

Figure 4-6. Spencer’s Pond Existing Features 139

Figure 4-7. Average Monthly Stream Flow at Gage Site 320..... 140

Figure 4-8. Concept Design Elements for the Spencer’s Pond Retrofit..... 141

Figure 4-9. Typical Cross-Section through Forebay..... 142

Figure 4-10. Typical Cross-Section through Vegetated Swale 144

Figure 4-11. Typical Cross-Section through Micropool 145

Figure 4-12. Little Cottonwood Creek Study Area 151

Figure 5-1. Plan Update and Permitting Process..... 176

Hidden codes on this page. Delete page from PDF.

1.0 INTRODUCTION

Since the late 1970s, Salt Lake County has provided planning and implementation to protect and improve the water quality of the county's surface waters. As part of its continuing area-wide (that is, county-wide) water quality planning, Salt Lake County has completed this *2015 Integrated Watershed Plan* (hereinafter referred to as the 2015 Plan) to update its 2009 *Salt Lake Countywide Water Quality Stewardship Plan* (hereinafter referred to as the 2009 Plan).

The 2015 Plan builds on the framework of goals and policies in the 2009 Plan. It does not reiterate all of the baseline information in the 2009 Plan, but rather updates information where needed and builds on that information. This document evaluates program efforts during the 6-year period between 2009 and 2015 (since adoption of the 2009 Plan). It analyzes current land-use projections, population projections, and monitoring data that have been gathered since the 2009 Plan was issued to provide an updated picture of current watershed conditions.

In addition, this document reports on pilot studies: a debris basin retrofit for Spencer's Pond and Little Cottonwood Creek instream flow analysis. With these studies and updated resource information, Salt Lake County has updated the goals, objectives, and implementation plans in the 2009 Plan to continue guiding water quality stewardship for future plan updates and long-term integrated watershed management in the county.

What do the terms *the County* and *the county* mean?

The term *the County* refers to the Salt Lake County government, while the term *the county* refers to the geographical area within the Salt Lake County government's jurisdictional boundary.

1.1 Area-Wide Water Quality Planning Authority

Section 208 of the federal Clean Water Act outlines the chain of responsibility for local, area-wide water quality planning. Section 208 grants authority to the states to identify water-quality planning areas and to identify a representative organization that will oversee water-quality planning in those areas. The State of Utah delegated **area-wide water quality planning authority** to the Salt Lake County government in 1978 (SLCO, 2009, Section 6.1.3). This designation as the area-wide water quality planning agency authorizes Salt Lake County to:

- Plan water quality related activities
- Provide for consistency of water quality related activities
- Enforce water quality related ordinances

What is a Clean Water Act Section 208 Plan?

A Section 208 plan describes and promotes efficient and comprehensive programs for controlling water pollution from point and nonpoint sources in a defined geographic area.

Salt Lake County has provided continuous water quality planning, starting with the reports that collectively make up the 1978 *208 Area-wide Water Quality Management Plan* (SLCOOG, 1978) and continuing through this update.

1.2 2009 Plan Background

In 2006, Salt Lake County began a comprehensive water quality planning process to update the 1978 208 Plan in order to reflect current conditions and the resulting 2009 Plan contains updated elements found in 208 Plan, while also incorporating elements of the U.S. Environmental Protection Agency *Handbook for Developing Watershed Plans to Restore and Protect Our Waters* (EPA, 2008).

The 2009 Plan was created through a collaborative 3-year process with agencies that hold water quality authorities and with jurisdictions that permit watershed activities. The Salt Lake County Watershed Planning and Restoration Program led a team of consultants; federal, state, and local agencies; special service districts; municipalities; the Salt Lake County Council of Governments; the Conference of Mayors; and community councils to conduct the analyses and prepare the 2009 Plan. In addition, public workshops and outreach activities were conducted during this process. The following paragraphs summarize the goals and objectives in the 2009 Plan.

Watershed Functions. The 2009 Plan focused planning activities on four watershed functions:

- Water quality
- Habitat (terrestrial and aquatic)
- Hydrology (flood conveyance and stream stability)
- Social and recreational services

Strategic Targets. Taking into account input from both internal and external stakeholders, Salt Lake County identified seven strategic targets to be analyzed in the 2009 Plan:

1. Reduce pollutant loads to receiving waters.
2. Develop regional wastewater planning procedures.
3. Evaluate the effects of Utah Lake source water and irrigation diversions and return flows on the watershed functions.
4. Protect and improve wetlands and stream channels to prevent erosion and sediment loss.
5. Increase stream corridor areas to improve watershed functions.
6. Evaluate instream flows required to support watershed functions.
7. Identify funding sources and mechanisms for implementation support.

The 2009 Plan included a general watershed characterization, information about implementation, and a monitoring approach. In addition, the County developed and implemented a rapid stream assessment tool to inventory and monitor stream functions, called the Stream Function Index (SFI). It was designed to help watershed managers achieve the goals of the 2009 Plan. In all, the

What is EPA's Watershed Planning Handbook?

The watershed planning handbook is a guidance document that can be used by communities, watershed organizations, and local, state, tribal, and federal environmental agencies develop and implement watershed plans to meet water quality standards and protect water resources.

County evaluated 245 miles of streams and 44 miles of the Jordan River using the SFI methodology.

The 2009 Plan recommended that Salt Lake County should conduct water quality planning every 6 years to update the previous plan. This update interval ensures that the elements of the previous water quality plan reflect changes such as new regulations, stakeholder input, and changed resource conditions and that the plan is consistent with ongoing area-wide water quality planning and the adaptive-management principles included in the 2009 Plan.

The 2009 Plan was approved by the Governor of the State of Utah on May 4, 2009 (State of Utah, 2009) and was accepted by EPA on November 2, 2010 (EPA, 2010).

1.3 Plan Purpose

This 2015 Plan continues the area-wide water quality planning process and updates the 2009 Plan. By focusing on the overriding goal of improving watershed functions and providing high-quality surface waters that support the national Clean Water Act goals of fishable and swimmable waters, this 2015 Plan provides:

- An updated Section 208 plan
- An updated watershed plan
- A roadmap to guide Salt Lake County’s watershed improvements

This document identifies whether and how resource conditions, or the applicable resource regulations, have changed since the 2009 Plan was adopted. Some conditions have changed very little or not at all (soils and geology, groundwater, and geomorphology) and are incorporated by reference into this 2015 Plan but not addressed directly.

This document integrates the 2009 Plan with updated data and information to better address ongoing area-wide water quality planning and watershed planning. Salt Lake County will update the Integrated Watershed Plan every 10 years or sooner if needed. Reference Chapter 5 Section 5.8, Procedural for more information on the plan update process.

What is geomorphology?

Geomorphology as analyzed in the 2009 Plan refers to the stability conditions of the streams and rivers and modifications made to streams and rivers and their alignments to accommodate urban development.

1.4 Organization of This Document

The 2015 Plan considers resource information from the 2009 Plan; data collected since the 2009 Plan was completed; other updated resource information available from federal, state, and local agencies; and accomplishments since the 2009 Plan was adopted. The 2015 Plan also identifies recommendations that will enable the County to continue to address the watershed functions and strategic targets listed in Section 1.2, 2009 Plan Background.

Following this introductory chapter, the 2015 Plan is organized as follows:

Six-year program review (Chapter 2)

Watershed characteristics (Chapter 3)

- General watershed information, such as watershed and sub-watershed areas, streams and rivers in the watershed, 303(d) Impaired Waters List, municipalities in the watershed, and information about jurisdictions and land-management agencies
- Population and land use
- Social and recreation functions
- Environmental justice populations and water quality
- Water quality conditions
- Habitat
- Climate change considerations
- Relationship between water and energy

What is the 303(d) Impaired Waters List?

The 303(d) Impaired Waters List refers to Section 303(d) of the Clean Water Act, which requires the State of Utah to identify surface waters that do not meet water quality standards.

Watershed planning element analyses (Chapter 4)

- Stormwater discharges
- Water supply
- Municipal and industrial wastewater point-source discharges
- Pilot studies
 - Debris basin retrofit study: Spencer’s Pond
 - Instream flow analysis for Little Cottonwood Creek

Implementation (Chapter 5)

- Watershed stressors
 - Sub-watershed characteristics and condition summary table
- Opportunities
- Implementation
 - Guiding polices
 - Specific implementation tasks
- Public and stakeholder involvement, education, and information
- Monitoring
- Plan amendment process

2.0 SIX-YEAR EVALUATION

This chapter describes the implementation process of the 2009 Plan and summarizes the results of implementation tasks and projects undertaken by the County Watershed Planning and Restoration Program since 2009.

2.1 High Priority Implementation Tasks from the 2009 Plan

The 2009 Plan focused on policies, existing condition assessments, and projects (collectively referred to as *tasks*) that focus on four watershed functions:

- Water quality
- Habitat (terrestrial and aquatic)
- Hydrology (stream bank and stream stability)
- Social and recreational services

To address these functions, the 2009 Plan contained recommendations for countywide implementation with a caveat that many would require substantial funding over a number of years. From these recommendations, the County identified 15 high priority implementation tasks based on findings presented in the 2009 Plan (SLCO 2009, Section 6.4.2) and on stakeholder input that the County received during the planning process.

In addition to addressing the four watershed functions, the County has also continued to improve stream conveyances for flood-control purposes by increasing flood flow capacity, removing accumulated sediments, and stabilizing stream banks. The 2015 Plan does not discuss these flood-control projects in detail, but the County intends to continue implementing flood-control services concurrent with water quality, habitat, and social and recreation projects consistent with the 2009 Plan and this update.

The County intended to target the priority implementation tasks from the 2009 Plan during the first 6 years after the plan was published while continuing to work toward accomplishing the full set of countywide recommendations over time. Table 2-1 lists the 15 priority implementation tasks and summarizes the progress made on the tasks so far.

Table 2-1. Priority Implementation Tasks from the 2009 Plan

Implementation Task	Implementation Summary
1 Encourage the adoption of Leadership in Energy and Environmental Design (LEED) criteria. ^a	The draft <i>Cooperative County Plan</i> (- Salt Lake County 2013) discusses best practices for land-use planning, resource management, and environment. Examples include water conservation, sustainable development patterns, energy efficiency, and low-impact development.
2 Develop a sensitive area overlay zone template for the west side of the county (unincorporated areas and within cities).	The County began working on a riparian ordinance in 2010. The ordinance was not completed, and the work was put on hold, due to the economic downturn.
3 Establish a maximum impervious surface limit for site developments in unincorporated areas of the county.	The County's zoning ordinance establishes site coverage maximums by zoning district. These site coverage maximums do not specify coverage in terms of impervious surfaces.
4 Develop a countywide watershed water quality predictive management tool.	The County developed a countywide watershed model in partnership with UDWQ in 2011. The hydrologic and water quality model is a decision support tool for managing water quality and prioritizing improvement projects in the watershed; the model is a Hydrologic Simulation program–FORTRAN (HSPF) model that simulates instream water quality under various flow conditions based on land use.
5 Expand water quality and quantity data collection.	<ul style="list-style-type: none"> • Since 2009, the County has been collecting water quality data countywide. • The County collects quantity data using existing gages and using new gages on Midas Creek, Bingham Creek, and Rose Creek. • The County has been coordinating with UDWQ to sample macroinvertebrates at 60 sites countywide with the intention of using the data to assess water quality. This activity has been ongoing during the 6-year period. • The County also worked with partners to collect and monitor conditions for Emigration Creek (in support of the Emigration Creek total maximum daily load [TMDL] and Parley's Creek (in support of the Parley's Creek Partnership) throughout the 6-year period. • The <i>Salt Lake County 2014 Stormwater Management Plan</i> includes an objective to develop and implement an illicit-discharge detection and elimination plan. Implementing this plan will include outfall screening for illicit and illegal discharges to receiving waters through the storm drain system.
6 Develop a wetland assessment program that augments existing data.	The County staff participated in wetland delineation training. The countywide wetland assessment program was evaluated and is on hold. However, site specific delineations are being conducted to assist with planning and permitting projects.
7 Evaluate current lower Jordan River flow-management strategies for impacts to water quality.	Current evaluation of flows in the lower Jordan River is being conducted by the Jordan River Commission in partnership with UDWQ and the River Network. This evaluation follows a study conducted by the Salt Lake City Department of Public Utilities and the River Network that assessed the effects of varying lower Jordan River flows on water quality parameters of concern associated with the Jordan River TMDL.
8 Implement a public involvement plan.	<ul style="list-style-type: none"> • The County and the Salt Lake County Stormwater Coalition (Coalition) implemented a program for public education and outreach regarding stormwater impacts • The County Stormwater program implemented a public involvement/participation program providing opportunities for public participation (one such opportunity is a used-oil-collection sub-program). The County's <i>2014 Stormwater Management Plan</i> includes goals and assessment metrics. • In 2014 the County published the <i>Stream Care Guide: A Handbook for Residents of Salt Lake County</i>. This free 57-page guide was mailed to County residents that live along streams and all residents in Emigration Canyon. Copies are available for the interested public. • The County participates in several other public outreach programs and events, such as an annual Watershed Symposium, the <i>I Love Jordan River</i> program, and conducts a periodic watershed public opinion survey to assess programs.
9 Maintain and update a stream function index (SFI).	The County conducts ongoing water quality, biological and physical habitat data collection to evaluate functional index scores.
10 Develop countywide water quality design criteria for stormwater management facilities.	The County's 2012 Guidance Document includes long-term stormwater management practices and identifies pollutants of concern and site performance standards.

Table 2-1. Priority Implementation Tasks from the 2009 Plan

Implementation Task	Implementation Summary
11 Maintain and update the 2009 Plan. Develop consistency review procedures.	The 2015 Plan updates the 2009 Plan. The County’s annual Jordan River Watershed coordinator’s report includes yearly summary of supporting projects and programs, funding sources and amounts, target pollutants, and a summary of project percent complete.
12 Provide assistance, coordination, facilitation, and oversight for water quality improvement grant applications.	The County works with several partners to fund and construct water quality improvement projects countywide. For more information about the water quality projects and programs conducted since 2009, see Table 2-2, Project Implementation Summary 2009-2015 .
13 Sample instream water quality during storms.	The County developed a sampling plan to collect instream water quality data during storm events (in unincorporated areas of the county only).
14 Conduct stream restoration and/or enhancement and maintenance. ^b	The County completed or was a partner for many stream restoration projects in the watershed. See Table 2-2, Project Implementation Summary 2009-2015 for project details and costs.
15 Implement best management practices (BMPs) for stormwater quality purposes.	The County implements construction-related BMPs for active project construction sites and post-construction water quality measures are conducted for County engineering projects (in unincorporated areas of the county only).

Source: Salt Lake County, 2015

^a These criteria encourage adopting sustainable green building and development practices through implementing universally understood and accepted tools and performance criteria. The criteria promote a whole-building approach to sustainability by recognizing performance in areas of human and environmental health.

^b Includes channel restoration and/or enhancement, riparian buffer restoration and/or enhancement, riparian wetland restoration and/or enhancement, stream daylighting, bioengineered bank stabilization, and streambank revegetation.

2.2 Summary of Accomplishments

The County has implemented projects over the past 6 years, working with nongovernmental organizations and private, local, state, and federal partners to address water quality through public outreach and education, data collection, detailed studies, stream restoration, and bank-stabilization projects throughout the county.

The project partners that were instrumental in planning, funding, and implementing these projects include but are not limited to:

- Cities
- Service districts
- UDWQ
- Utah Division of Wildlife Resources
- Jordan River Commission
- EPA
- U.S. Forest Service
- University of Utah
- Natural Resources Conservation Service, Utah office
- Salt Lake Conservation District
- Tree Utah
- The River Network
- Center for Documentary Expression and Art
- Private property owners

Figure 2-1 illustrates the stream restoration projects that the County participated in and implemented to address water quality, habitat, hydrology (stream stability), and social and recreational services between 2009 and 2015.

Figure 2-1. Stream Restoration Locations, 2009 - 2015

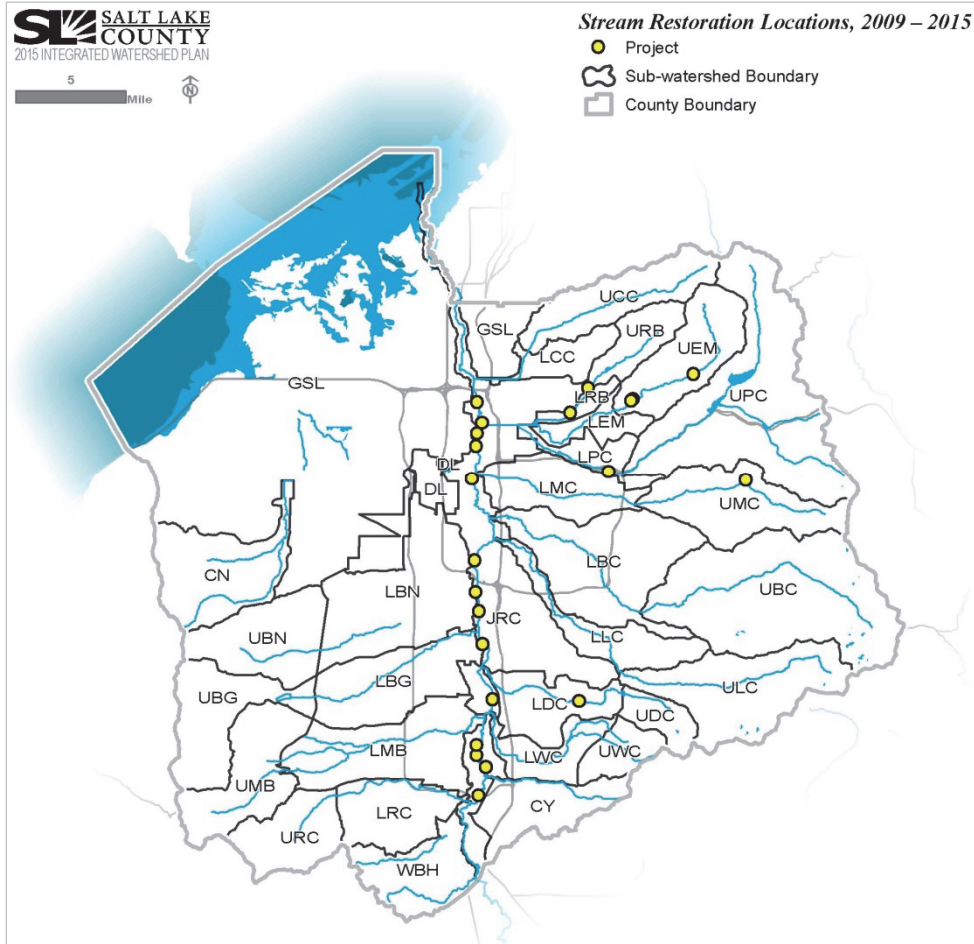

The County’s restoration and bank-stabilization projects along the Jordan River were planned, designed, and implemented to reflect an emergent bench design (as shown in Figure 2-2) and have evolved to incorporate natural channel design principles as well. This typical cross-section for the Jordan River is designed to achieve multiple goals including stabilizing the bank (reducing sediment loss), increasing riparian habitat, reconnecting to the floodplain, and providing the hydraulic capacity to convey flood flows.

Figure 2-2. Typical Jordan River Emergent Bench Design

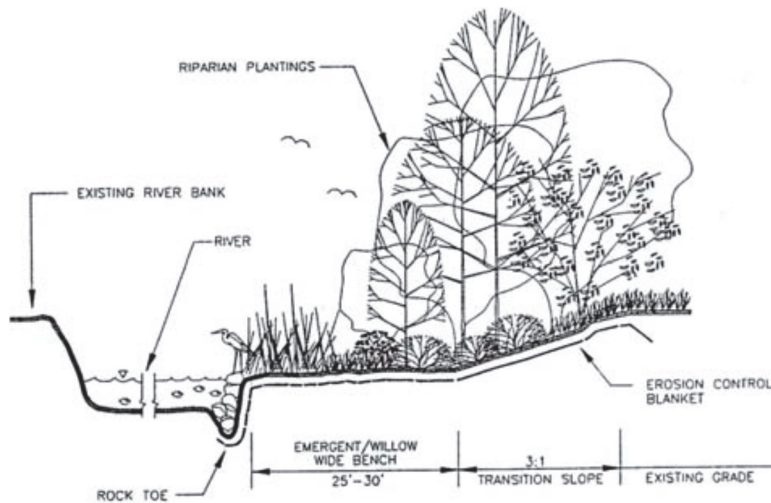

Table 2-2 further describes the projects that the County implemented to address bank stability and stream restoration as well as other countywide implementation projects. The table identifies the project, year completed, cost, and watershed functions addressed. The table organizes these projects according to the priority implementation tasks from the 2009 Plan.

Table 2-2. Project Implementation Summary, 2009 - 2015

Project Description	Year Completed	Project Cost (\$)			Watershed Functions Addressed			
		Total	County	Partner	Water Quality	Habitat	Hydrology	Social
Expand Data Collection (2009 Plan Priority Implementation Tasks 4, 5, and 9)								
Installed new flow and water quality data-collection gages in Bingham, Dry Midas and Rose Creeks	2010	300,000	190,000	110,000	✓		✓	
Developed watershed water quality model (HSPF) to help plan and implement water quality improvements	2011	300,000	100,000	200,000	✓			
Installed Red Butte stream gage at Miller Park (about 900 South 1700 East, Salt Lake City)	2014	40,000	0	40,000	✓	✓	✓	
Conduct water quality sampling and physical habitat monitoring	Ongoing	150,000	137,000	13,000	✓	✓		✓
Conduct macroinvertebrate sampling throughout the county to assess water quality based on macroinvertebrate populations	Ongoing	130,000	124,400	5,600	✓	✓		
Expand Data Collection Total		920,000	551,400	368,600				

Table 2-2. Project Implementation Summary, 2009 - 2015

Project Description	Year Completed	Project Cost (\$)			Watershed Functions Addressed			
		Total	County	Partner	Water Quality	Habitat	Hydrology	Social
Public Outreach and Involvement (2009 Plan Priority Implementation Tasks 8 and 12)								
Develop <i>I Love Jordan River</i> outreach program	2009	69,000	31,050	37,950	✓			✓
Conduct periodic watershed public opinion survey	2010, 2015	20,000	20,000	0				✓
Parley's Park Plan (2700 East 2700 South, Salt Lake City); participated in collaborative management plan	2011	0	0	0	✓	✓	✓	✓
Published <i>Stream Care Guide: A Handbook for Residents of Salt Lake County</i>	2014	73,200	42,100	31,100	✓	✓	✓	✓
With partners develop myjordanriver.org website and school residency programs	2015	65,900	10,000	55,900	✓	✓	✓	✓
Hold annual Watershed Symposium	Ongoing	99,000	88,000	11,000	✓	✓	✓	✓
Publish bi-annual <i>Watershed Watch</i> newsletter	Ongoing	15,000	15,000	0				✓
Lead and participate in Jordan River Watershed Council and attend Utah Watershed Coordinating Council meetings	Ongoing	360,000	0	360,000	✓	✓	✓	✓
Public Outreach and Involvement Total		702,100	206,150	495,950				
Stream Restoration and Bank Stabilization (2009 Plan Priority Implementation Task 14)								
Jordan River – Walden Park wetland mitigation site (5400 South to 5600 South, Murray): regraded steep bank into emergent bench design and revegetated	2009	200,000	80,000	120,000	✓	✓	✓	✓
Jordan River – Roi Hardy Park (12100 South to 12200 South, Riverton): emergent bench design and stabilization	2009	250,000	150,000	100,000	✓	✓	✓	

Table 2-2. Project Implementation Summary, 2009 - 2015

Project Description	Year Completed	Project Cost (\$)			Watershed Functions Addressed			
		Total	County	Partner	Water Quality	Habitat	Hydro-logy	Social
<p>The American Recovery and Reinvestment Act of 2009 (ARRA) provided funding for the following sites that were identified and designed for bank stabilization and restoration in the Jordan River Study 206 Plan.</p> <p>Jordan River</p> <ul style="list-style-type: none"> • Site 1 (600 South, Salt Lake City): bank stabilization using an emergent bench design; revegetation • Site 2, Modesto Park (1200 South, Salt Lake City): bank stabilization using an emergent bench design; revegetation • Site 3, 1700 South Park (Salt Lake City) • Site 4, Glendale Golf Course (2000 South, Salt Lake City) • Site 13 (10500 South, South Jordan): installed grade-control structure • Site 17, Riverbend Cliff (12600 South, Riverton): regraded slope; bank stabilization; revegetation • Site 18 (12900 South, Draper) 	2010	1,045,000	0	1,045,000	✓	✓	✓	
Jordan River – oxbow restoration (3100 South, West Valley City): bank stabilization; regraded steep bank into emergent bench; revegetation	2010	95,000	38,000	57,000	✓	✓	✓	
Jordan River – 8600 South to 9000 South (West Jordan): emergent bench stabilization; added toe protection; weed treatment; debris removal	2010	426,050	64,050	362,000	✓	✓	✓	
Jordan River^a – Midvale Slag Superfund Site (Bingham Junction, 6400 South to 7800 South, Midvale): stabilized 700 linear feet of eastern stream bank; included 4 th grade education program	2009	1,500,000	0	1,500,000	✓	✓	✓	✓
Jordan River^a – 12600 South Bank Restoration at Rotary Park (12600 South, Draper): regraded 474 linear feet of east bank; bank stabilization and four instream cross vanes; weed control and revegetation	2011	75,000	75,000	0	✓	✓	✓	
Jordan River^a – Bangerter Parkway Trail (about 14000 South, Bangerter Highway, Riverton and Bluffdale): north of highway; regraded west bank; revegetation	2013	68,000	68,000	0	✓	✓	✓	✓
Jordan River – Winchester (6400 South, Murray): installed navigable boat passage; recontoured river channel; installed three rock cross vanes	2014	636,000	150,000	486,000	✓	✓	✓	✓
Jordan River^a – Murray/Taylorville (5200 South to 4800 South): 3,000 linear feet of west bank stabilization; regrading; revegetation; weed control	2015	487,000	50,000	437,000	✓	✓	✓	

Table 2-2. Project Implementation Summary, 2009 - 2015

Project Description	Year Completed	Project Cost (\$)			Watershed Functions Addressed			
		Total	County	Partner	Water Quality	Habitat	Hydrology	Social
Lower Dry Creek – restoration at Dimple Dell Park (700 East to 1300 East, Sandy): meander replacement and bioengineering bank stabilization	2010	550,000	220,000	330,000	✓	✓	✓	
Mill Creek – participated in stocking cutthroat trout	2013	0	0	0		✓		✓
Upper Emigration Creek – installed conifer revetments for bank stabilization	2013	0	0	0	✓	✓	✓	
Lower Emigration Creek <ul style="list-style-type: none"> Rotary Glen Park (2950 East to 3000 East, Salt Lake City): revegetated debris basin and just upstream (riparian plants and seed) to provide <i>E. coli</i> treatment; regraded and revegetated steep slopes(plants and seed); installed fencing to restrict dog access Below Hogle Zoo to Clayton Middle School (1800 East to 2450 East, Salt Lake City): instream and bioengineered bank stabilization and revegetation 	2014	45,600	27,360	18,240	✓	✓	✓	✓
Lower Red Butte Creek^a – Riparian restoration as a result of the Chevron oil spill (Red Butte Garden to Foothill Drive): bioengineering; instream rock structures; bank stabilization and revegetation	2014	136,215	0	136,215	✓	✓	✓	✓
Stream Restoration and Bank Stabilization Total		5,514,365	922,410	4,591,955				
Program Total		7,136,465	1,679,960	5,456,505				

^a Project included to estimate streambank stabilization costs per mile

The County further analyzed project-specific data from five of the stream restoration projects listed in Table 2-2: Lower Red Butte Creek and four projects on the Jordan River (Murray/Taylorville, Midvale Slag Superfund Site at Bingham Junction, 12600 South, and Bangerter Parkway Trail).

These five projects stabilized about 12,400 linear feet of stream banks for a total cost of about \$2,266,215, with an average unit cost of \$183 per linear foot, or about \$966,250 per mile. These costs do not include any land purchases.

The County has also estimated the amount of sediment removed by three of these bank-stabilization projects. Using data from the Murray/Taylorville, 12600 South, and Lower Red Butte Creek projects, the County estimated that these three projects reduced the sediment load to their respective receiving waters by about 73,000 pounds per year, for a total capital cost of about \$698,215.

Although these projects range in complexity, size, funding partners, and project goals, they reflect the varying nature of stream restoration projects. The County conducted this planning-level cost analysis to better plan and fund future stream bank stabilization and restoration projects.

2.3 Summary of Implementation Process

For the period of 2009 to 2015, the County conducted numerous activities focused on improving area-wide water quality and implementing the recommendations in the 2009 Plan. These include studies, public involvement, watershed coordination meetings, and design and construction of streambank restoration projects. These activities were accomplished with Salt Lake County Watershed Planning and Restoration staff, stakeholders, and partners and in support of the other water quality improvement projects located throughout the county.

There were no formal amendments to the 2009 Plan prepared during the period of 2009 to 2015.

The County's review of projects and activities conducted over the past 6 years indicates that:

- The County has leveraged about \$1.6 million into about \$7.1 million to implement projects and conduct activities through partnerships to improve water quality.
- The County has worked successfully to implement stream restoration projects and conduct public outreach and agency coordination associated with improving area-wide water quality.
- The County should continue to pursue opportunities to partner with federal, state, and local agencies and private property owners to implement planning and restoration projects related to water quality.
- The Utah DWQ, and specifically the non-point source and watershed coordination programs, has provided many forms of support and opportunities, including training through the Watershed Planning and Restoration Program. This partnership benefits not only the Watershed Planning Program and Salt Lake County but also the Jordan River watershed as a whole.
- Currently, there are no concerns regarding the delivery of the County Watershed Planning and Restoration Program projects in the Jordan River watershed.
- The County is looking to continue capacity-building partnerships with internal and external organizations in the effort to leverage county funding for countywide water quality, hydrology, habitat and social and recreational improvement project opportunities.

This page is intentionally blank.

3.0 WATERSHED CHARACTERIZATION

Watershed characterization is the process of collecting and analyzing data on historic and current watershed conditions to determine the actions needed to improve watershed health. The initial characterization of Salt Lake County’s watersheds and sub-watersheds, completed for the 2009 Plan, included a review of physical, biological and chemical conditions, as well as social components such as population growth and recreational use.

This chapter reviews the watershed characteristics documented in the 2009 Plan and updates the characteristics that pertain to population and land use, social and recreational functions, water quality, habitat, and climate change. This chapter also adds a summary of the water-energy nexus.

3.1 General Watershed Information

This section describes Salt Lake County’s watersheds, streams and rivers, applicable regulatory designations, municipalities and townships, and the jurisdictions and land-management agencies that have authority within the watershed.

Watershed Area & Regional Context

Salt Lake County encompasses 805 square miles (515,600 acres) and is part of the 813 square mile Jordan River Subbasin, which, along with the Spanish Fork, Provo River and Utah Lake Subbasins, comprise the 3,805 square-mile Jordan River Basin.

The Jordan River Basin is part of the 21,000 square-mile Great Salt Lake Subregion, a closed hydrologic basin. The vast majority of fresh water entering Great Salt Lake comes from the Jordan, Bear, and Weber Rivers. The hydrologic units of (subregion, basin, subbasin) are defined by the USGS Watershed Boundary Dataset. The Jordan River Basin and other hydrologic basins in Utah are shown on Figure 3-1.

Watersheds often cross city, county, and state boundaries, posing challenges to planning and protection. Salt Lake County is contained almost entirely within the 813-square mile lower Jordan River Subbasin (hereinafter referred to as the Watershed).

About 38% (307 square miles) of the Watershed is the rugged Wasatch and Oquirrh Mountain ranges, which bound the county on the east and west. These mountain ranges are mostly undeveloped and are likely to remain that way due to their topography.

About 17% (134 square miles) of the Watershed has additional land-management requirements that are intended to ensure long-term protection of good-quality drinking water for Salt Lake City and the city of Sandy.

What is a watershed?

A watershed is an area within which all surface water drains into the same waterbody. Watersheds are typically defined by topography and drainage patterns.

Figure 3-1. Utah Hydrologic Basins

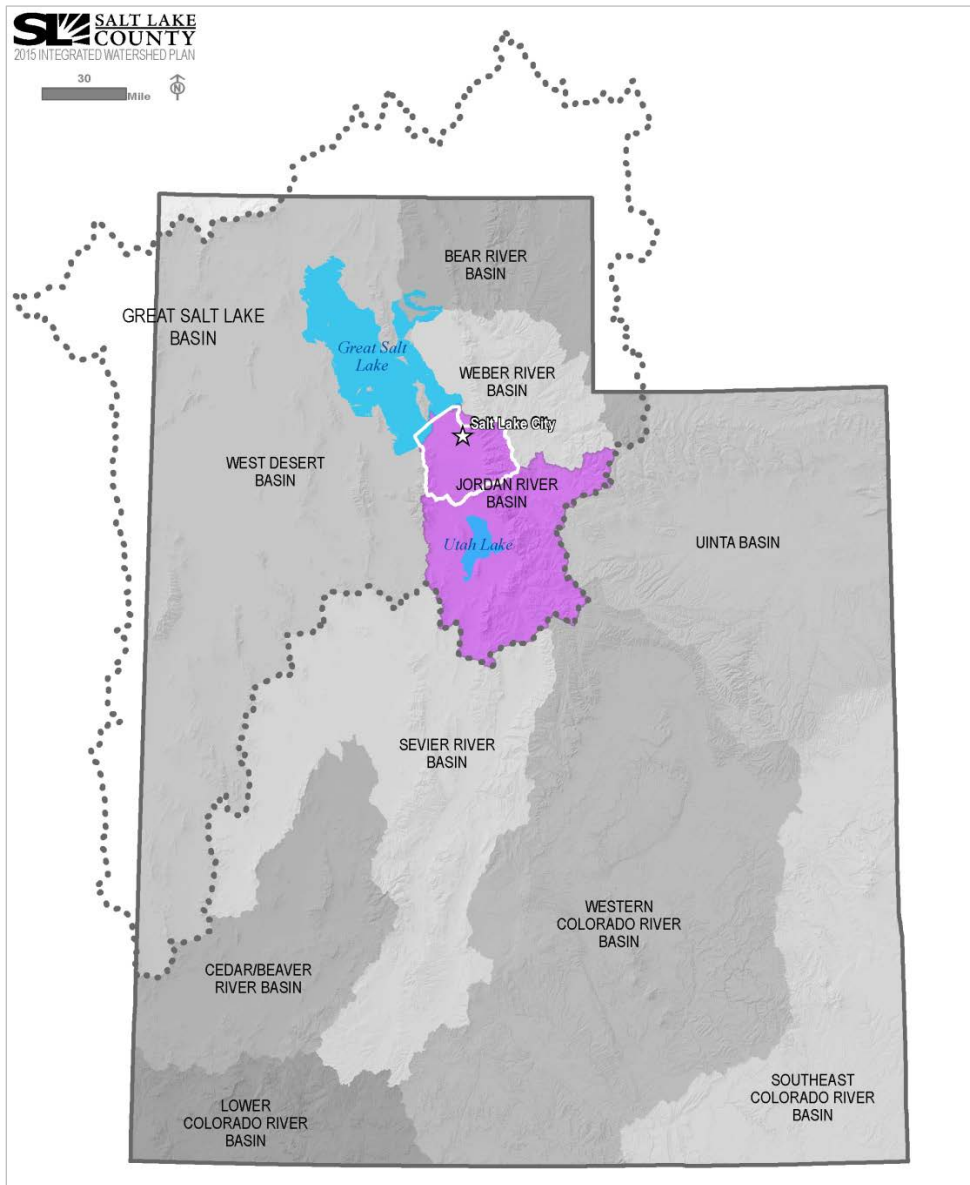

Streams and Rivers

Ten streams originate on the east side of the county in the Wasatch Mountains, and eight streams originate on the west side in the Oquirrh Mountains, as shown in Figure 3-2. The Jordan River, the only river in the county, originates as the outflow from Utah Lake to the south, flows northerly into and through the county, and eventually discharges to the Great Salt Lake.

The major waterbodies in the watershed, and their respective boundaries, are contained entirely within the county, except for the Jordan River and Great Salt Lake. All watersheds within the county discharge to either the Jordan River or the Great Salt Lake

Each stream or river in the county is categorized as perennial (capable of flowing year-round) or intermittent (flows seasonally or with storm events, and at times is dry). In addition to the

perennial and intermittent flow categories, sub-categories of reduced and interrupted were identified in the 2009 Plan. Table 3-1 lists the stream or river, its sub-watersheds, its source, general classification as perennial or intermittent, and stream miles for the main stem of each stream or river in the county.

In addition to natural streams and rivers, constructed irrigation and drainage canals traverse the county. Water is managed through these systems of canals and drains for agricultural, municipal, and flood-control purposes.

Figure 3-2. Salt Lake County Setting

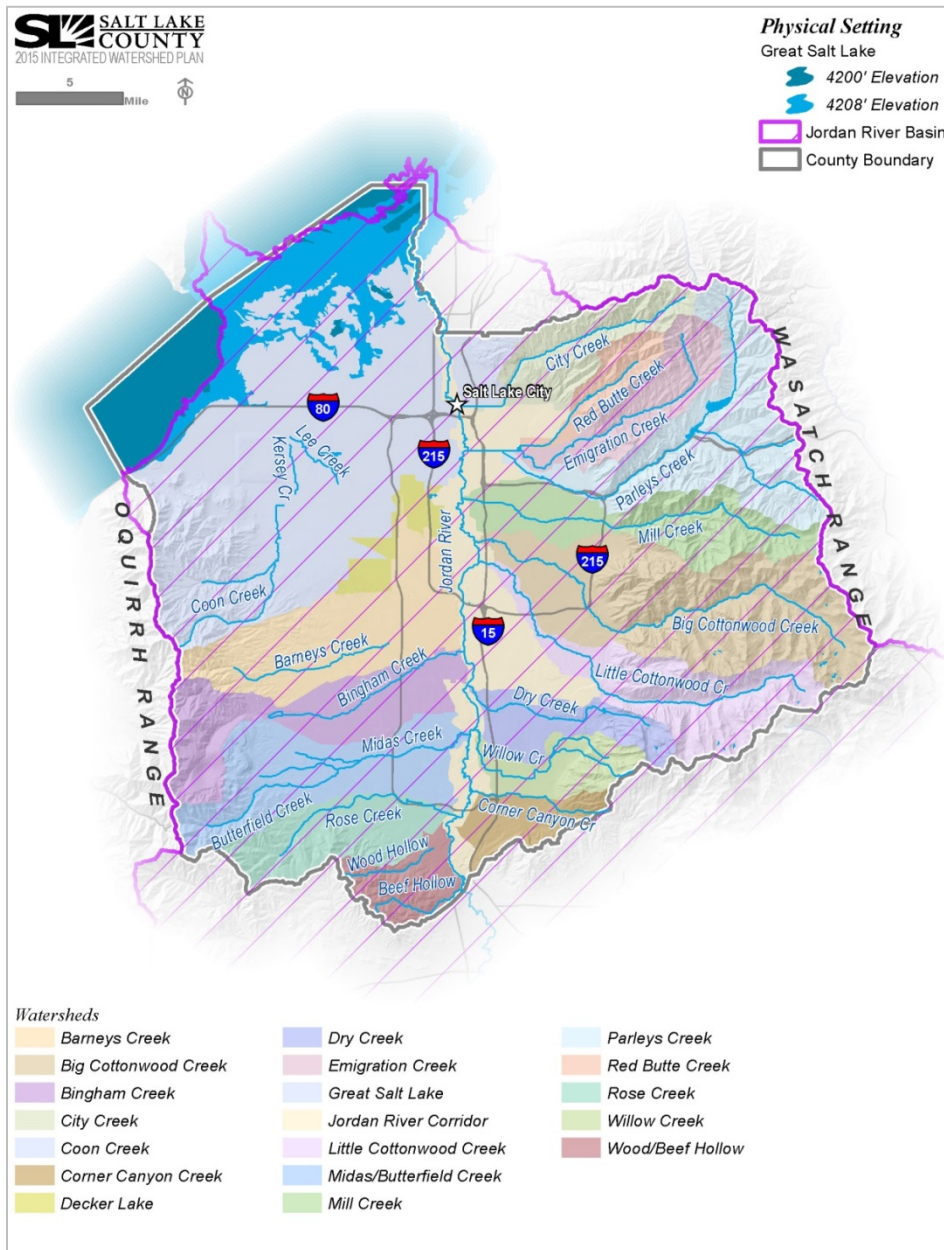

Watershed and Sub-watershed Boundaries

The watershed and sub-watershed boundaries have been revised and updated for this 2015 Plan. In the 2009 Plan, Salt Lake County was delineated into 17 watersheds based on topography in the mountains and stormwater drainage areas in the valley. In order to provide increased resolution of specific issues and management practices, nine creek watersheds on the east side of the county and the area of land draining directly to the Great Salt Lake were further delineated into sub-watersheds. These finer-scale delineations were based primarily on management practices and jurisdiction. The resulting 27 watersheds/sub-watersheds functioned as the planning units for the 2009 Plan.

The 2015 Plan includes a total of 32 watershed/sub-watershed planning units. This change reflects the delineation of a new Wood and Beef Hollow watershed, by removing the drainage from the Jordan River Corridor watershed. It also reflects the further delineation of the Rose, Midas/Butterfield, Bingham, and Barneys Creek watersheds into upper/lower sub-watersheds. As with the 2009 Plan, these upper/lower delineations are intended to provide increased resolution of specific issues and management practices. In addition to the new delineations, the boundaries of the Rose, Midas/Butterfield, Bingham and Barneys Creek watersheds were slightly modified to align with previous Salt Lake County drainage area mapping and system-planning studies (SLCO 2003).

The 2015 Plan delineates 18 watershed and 32 sub-watersheds (see Figure 3-3 and Table 3-1).

Figure 3-3. Watersheds and Sub-watersheds in Salt Lake County

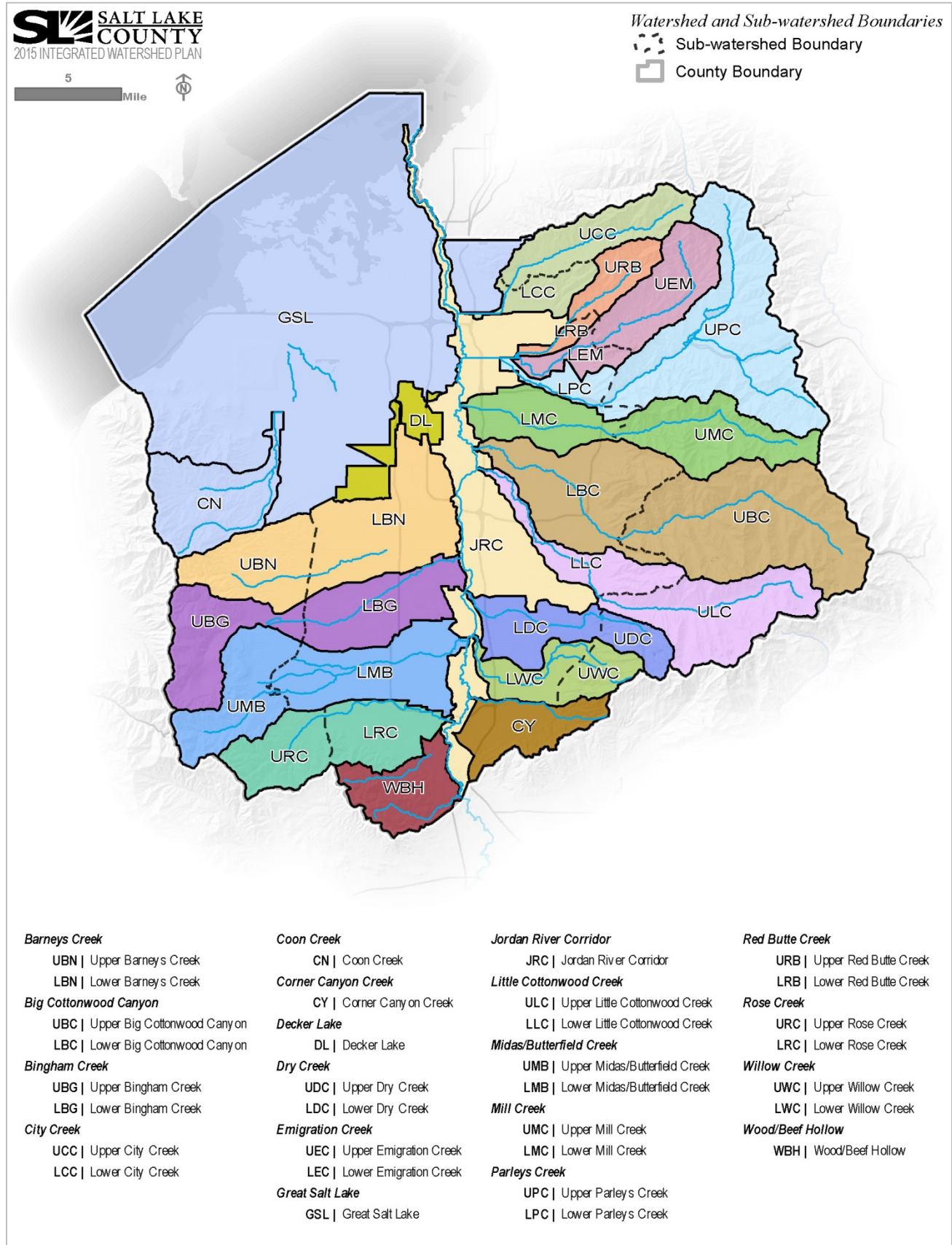

Table 3-1. Watersheds and Sub-watersheds in Salt Lake County

Watershed	Sub-watershed			Waterbody			
	Name	Abbreviation	Area (square miles)	Name	Source ^a	Classification ^b	Length ^c (miles)
Barneys Creek	Upper Barney's Creek	UBN	19.0	Barneys Creek	Oquirrh	Intermittent	4.3
	Lower Barney's Creek	LBN	31.6				4.2
Big Cottonwood Creek	Upper Big Cottonwood Creek	UBC	49.9	Big Cottonwood	Wasatch	Perennial	14.5
	Lower Big Cottonwood Creek	LBC	31.6				10.4
Bingham Creek	Upper Bingham Creek ^d	UBG	18.9	Bingham Creek	Oquirrh	Intermittent	1.1
	Lower Bingham Creek ^d	LBG	20.7				8.9
City Creek	Upper City Creek	UCC	17.4	City Creek	Wasatch	Perennial	11.2
	Lower City Creek	LCC	7.2				2.9
Corner Canyon Creek	Corner Canyon Creek	CY	14.6	Corner Canyon Creek	Wasatch	Perennial	8.2
Decker Lake	Decker Lake	DL	9.7	Decker Lake	NA	Lake	NA
Dry Creek	Upper Dry Creek	UDC	6.1	Dry Creek	Wasatch	Perennial	3.5
	Lower Dry Creek	LDC	13.4				9.2
Emigration Creek	Upper Emigration Creek	UEM	18.2	Emigration Creek	Wasatch	Perennial	11.8 ^e
	Lower Emigration Creek	LEM	5.8				5.4
Great Salt Lake of Salt Lake County	Coon Creek	CN	22.6	Coon Creek	Oquirrh	Intermittent	18.5
	Great Salt Lake of Salt Lake County	GSL	121.2 ^f	Kersey Creek	NA	NA	2.6
				Lee Creek	NA	NA	4.0
				Great Salt Lake	NA	Lake	NA
Jordan River Corridor	NA	JRC	55.2	Jordan River	Utah Lake	Perennial	45.2 ^g
Little Cottonwood Creek	Upper Little Cottonwood Creek	ULC	27.2	Little Cottonwood Creek	Wasatch	Perennial	12.0
	Lower Little Cottonwood Creek	LLC	12.7				10.6
Midas/Butterfield Creek	Upper Midas/Butterfield ^d	UMB	19.5	Midas and Butterfield Creeks	Oquirrh	Intermittent	4.9
	Lower Midas/Butterfield ^d	LMB	25.1				18.8
Mill Creek	Upper Mill Creek	UMC	21.7	Mill Creek	Wasatch	Perennial	11.9
	Lower Mill Creek	LMC	15.2				8.4
Parley's Creek	Upper Parley's Creek	UPC	52.0	Parley's Creek	Wasatch	Perennial	25.9 ^h
	Lower Parley's Creek	LPC	6.4				5.7
Red Butte Creek	Upper Red Butte Creek	URB	8.4	Red Butte Creek	Wasatch	Perennial	4.7
	Lower Red Butte Creek	LRB	2.6				3.8
Rose Creek	Upper Rose Creek ^d	URC	13.8	Rose Creek	Oquirrh	Intermittent	3.6
	Lower Rose Creek ^d	LRC	14.7				7.6
Willow Creek	Upper Willow Creek	UWC	7.0	Willow Creek	Wasatch	Intermittent	4.2
	Lower Willow Creek	LWC	9.4				12.0
Wood and Beef Hollow ⁱ	NA	WBH	15.3	Wood Hollow	Oquirrh	Intermittent	5.1
				Beef Hollow			5.5
Total watershed/sub-watershed area			714.1	Total Stream Miles			310.7

^aPrimary waterbody source

^bAs classified by DEQ

^cMainstem length, unless noted

^dNew sub-watershed delineation for 2015 update

^eStream length includes Burr Fork Creek

^fDrainage area to Great Salt Lake (does not include open water, based on lake elevation of 4,217 feet)

^gJordan River length within County boundary

^hStream length includes Mountain Dell and Lamb's Creeks

ⁱNew watershed delineation for 2015 update

Regulatory Designations

Designated Beneficial Uses of Streams and Rivers

The Utah Division of Water Quality (UDWQ) determines beneficial-use classifications for waters of the state including streams, rivers, lakes, and reservoirs. A designated beneficial use of a water body must consider its actual use, the ability of the water to support in the future a use that is not currently supported, and the basic goal of the Clean Water Act that all waters support aquatic life and recreation where attainable.

Based on the beneficial-use classifications, specific numeric water quality standards apply (Utah Administrative Code [UAC] Rule R317-2-14). Narrative standards apply to all waters with beneficial-use designations (UAC R317-2-7.2).

In addition, waters of the state must support beneficial uses as determined by biological-assessment processes and biological criteria (UAC R317-2-7.3). State-determined beneficial uses are identified in Table 3-2.

Since the 2009 Plan, the UDWQ has identified five beneficial uses for the Great Salt Lake. These beneficial-use categories now differentiate between the open waters of the geographic bays (Gilbert, Gunnison, Bear River and Farmington) and the transitional wetlands (defined as below elevation 4,208 feet to the open water surface elevation of the bays). The spatial extents of the areas (open waters and transitional wetlands) will vary depending on the lake elevation. For illustrative purposes, Figure 3-4 following the table shows the three Great Salt Lake beneficial uses relative to the average lake level of 4,200 feet within the county.

In addition to the three beneficial-use categories assigned to the Great Salt Lake, seven beneficial-use classifications apply to the other waters in Salt Lake County (Figure 3-4). A large portion of the county does not contain surface waters with designated beneficial uses; these areas are shown in the figure as undefined. In these areas, stormwater is generally conveyed through municipal storm drain systems to larger ditches and drains that are designated flood-control facilities.

Figure 3-4 shows that all waterbodies that have assigned beneficial uses are protected for infrequent primary contact recreation and secondary contact recreation such as wading, hunting, and fishing (Classification 2B). The Great Salt Lake is protected for frequent and infrequent primary contact and secondary recreation (Classifications 5A, 5D, and 5E).

Designated uses for the southwestern part of the county, shown as lime green on Figure 3-4, are also protected for agricultural uses and waterfowl, shorebirds, and other water-oriented wildlife. The Great Salt Lake is protected for waterfowl, shorebirds, and other water-oriented wildlife use.

Protections for the Jordan River corridor vary slightly from south to north. The entire corridor is protected for agricultural uses. In addition to this protection, the southern part (from the outlet of Utah Lake to about the Jordan River Narrows) is protected for domestic water supply and warm-water aquatic species; the central part from the Narrows to the confluence with Little Cottonwood Creek is protected for cold-water aquatic species; and the northern part between Little Cottonwood Creek and the Great Salt Lake is protected for warm-water aquatic species and waterfowl, shorebirds, and other water-oriented wildlife

What are narrative standards?

Narrative standards are general statements that prohibit the discharge of waste or other substances that result in unacceptable water quality conditions such as visible pollution or undesirable aquatic life.

Table 3-2. Designated Beneficial Uses of Utah Waters

Class	Definition
1	Protected for use as raw water source for domestic water systems
1A, IB, IC	Reserved
2	Protected for recreational use and aesthetics
2A	Protect for frequent primary contact recreation where there is a high likelihood of ingestion of water or a high degree of bodily contact with the water. Examples include, but are not limited to, swimming, rafting, kayaking, diving, and water skiing.
2B	Protect for infrequent primary contact recreation. Also protected for secondary contact recreation where there is a low likelihood of ingestion of water or a low degree of bodily contact with the water. Examples include, but are not limited to, wading, hunting, and fishing.
3	Protected for use by aquatic wildlife
3A	Protected for cold water species of game fish and other cold water aquatic life, including the necessary aquatic organisms in their food chain.
3B	Protected for warm water species of game fish and other warm water aquatic life, including the necessary aquatic organisms in their food chain.
3C	Protected for nongame fish and other aquatic life, including the necessary aquatic organisms in their food chain.
3D	Protected for waterfowl, shore birds and other water-oriented wildlife not included in Classes 3A, 3B, or 3C, including necessary aquatic organisms in their food chain.
3E	Severely habitat-limited waters. Narrative standards will be applied to protect these waters for aquatic wildlife.
4	Protected for agricultural uses including irrigation of crops and stock watering
5	The Great Salt Lake
5A	Gilbert Bay. All open waters at or below approximately 4,208 foot elevation south of the Union Pacific Causeway, excluding all of the Farmington Bay south of Antelope Island Causeway and salt evaporation ponds. Protected for frequent primary and secondary contact recreation, waterfowl, shore birds and other water-orientated wildlife including their necessary food chain.
5B	Gunnison Bay. All open waters at or below approximately 4,208 foot elevation north of the Union Pacific Causeway and west of the Promontory Mountains, excluding salt evaporation ponds. Protected for infrequent primary and secondary contact recreation, waterfowl, shore birds and other water-orientated wildlife including their necessary food chain.
5C	Bear River Bay. All open waters at or below approximately 4,208 foot elevation south of the Union Pacific Causeway and east of the Promontory Mountains, excluding salt evaporation ponds. Protected for infrequent primary and secondary contact recreation, waterfowl, shore birds and other water-orientated wildlife including their necessary food chain.
5D	Farmington Bay. All open waters at or below approximately 4,208 foot elevation east of Antelope Island and south of Antelope Island Causeway, excluding salt evaporation ponds. Protected for infrequent primary and secondary contact recreation, waterfowl, shore birds and other water-orientated wildlife including their necessary food chain.
5E	Transitional Waters along the Shoreline of the Great Salt Lake. All waters below approximately 4,208 foot elevation to the current lake elevation of the open water of the Great Salt Lake receiving their source water from naturally occurring springs and streams, impounded wetlands or facilities requiring a UPDES permit. The geographical areas of these transitional waters change corresponding to the fluctuation of open water elevation. Protected for infrequent primary and secondary contact recreation, waterfowl, shore birds and other water-orientated wildlife including their necessary food chain.

Source: UAC R317-2-6

In addition to infrequent primary contact recreation and secondary contact recreation, most east-county upper sub-watersheds are protected for domestic water supply and cold-water aquatic species. Two upper sub-watersheds—upper Mill Creek and upper Emigration Canyon—are protected for cold-water aquatic species but are not protected for domestic water supply. These two upper sub-watersheds are also protected for agricultural uses. Most of the lower sub-watersheds in the southeast area of the county are do not have defined beneficial uses. Limited areas are protected for water supply (lower Parley’s Canyon only), cold-water aquatic species, and agricultural uses.

Figure 3-4. Designated Beneficial-Use Classifications of Waters in Salt Lake County

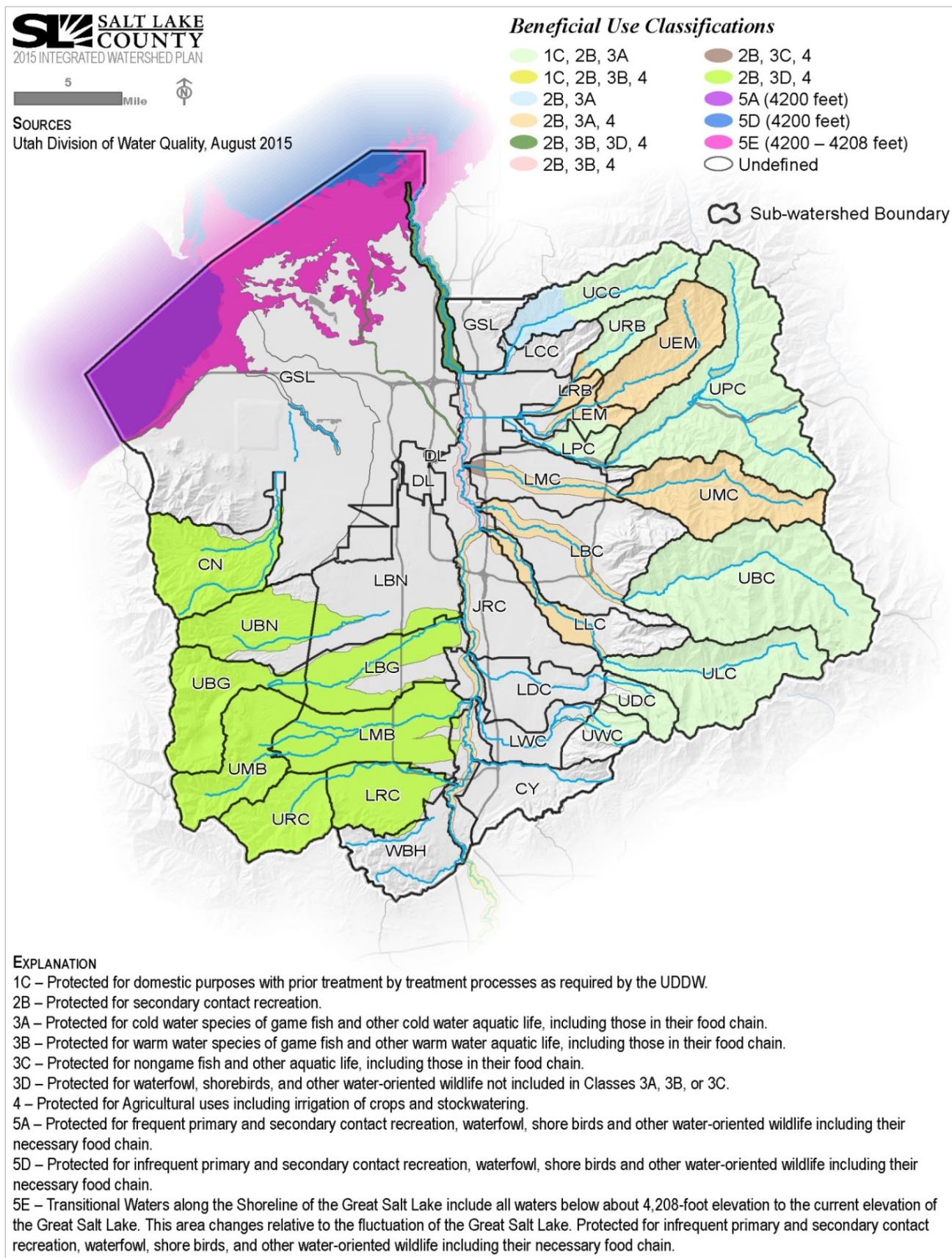

Impaired Waterbodies

Section 303(d) of the federal Clean Water Act requires all States to submit a list of impaired and threatened waters (stream/river segments and lakes) to EPA every 2 years on even-numbered years. The States then: (1) identify all waters where required pollution controls are not sufficient to attain or maintain applicable water quality standards, and (2) establish priorities for developing total maximum daily loads (TMDLs) based on the severity of the pollution and the sensitivity of the uses to be made of the waters, among other factors [40 CFR 130.7(b)(4)].

What are impaired waterbodies?

An impaired waterbody is a waterbody that has been identified as having chronic or recurring monitored violations of applicable water quality standards. Section 303(d) of the Clean Water Act requires the state to identify impaired waterbodies.

To comply with Section 303(d), UDWQ evaluates water quality monitoring data every 2 years to determine whether the surface waters of the state meet the specified water quality standards for their designated beneficial uses. Table 3-3 lists and Figure 3-5 show the assessment categories and subcategories used to classify waterbodies, as defined in UDWQ’s 2014 draft Integrated Report on the condition of Utah’s rivers, streams, lakes, and wetlands (UDWQ 2014).

Table 3-3. Water Quality Assessment Categories and Subcategories

Category	Sub-category	Definition
1	NA	All designated beneficial uses are attained.
2	NA	Some of the designated beneficial uses are attained, but there are insufficient data to determine whether the waterbody supports the remaining designated beneficial uses.
3	There are insufficient data to make a determination, or lakes and reservoirs show indication of impairment for a single monitoring cycle. The following six subcategories are used for planning purposes.	
	3A	Insufficient data and information are available to make an assessment, and the data include violations of water quality criteria.
	3B	Includes lakes and reservoirs that have been assessed as not supporting a beneficial use for one monitoring cycle.
	3C	This category is used for the Great Salt Lake. Because the lake is naturally hypersaline, traditional assessment methods are not appropriate. UDWQ is developing both numeric criteria and assessment methods for this ecosystem.
	3D	Further investigations are required. Waterbodies with potential impairments for nutrients and biochemical oxygen demand are included until numeric nutrient criteria are developed.
	3E	There are insufficient data and information to make an assessment, and the data do not include violations of water quality criteria.
	3F	An assessment was not performed due to missing designated beneficial-use information. These waters will be assigned designated beneficial uses in UDWQ’s next Integrated Report (2016).
4	Impaired for one or more designated beneficial uses, but a TMDL is not needed.	
	4A	TMDL has been completed for any pollutant. Where more than one pollutant is identified and requires a TMDL, waters can be listed in both Categories 4A and 5.
	4B	Other pollution-control requirements are reasonably expected to lead to the water quality standard being attained in the near future.
	4C	The impairment is not caused by a pollutant (but is instead caused by other factors such as habitat alteration or hydromodification, for example).
5	The concentration of a pollutant—or several pollutants—exceeds numeric water quality criteria, or quantitative biological assessments indicate that the biological designated beneficial uses are not supported (narrative water quality standards are violated).	

Source: UDWQ 2014, pp. 6–8

Figure 3-5. DWQ Assessment of Stream and River Segments

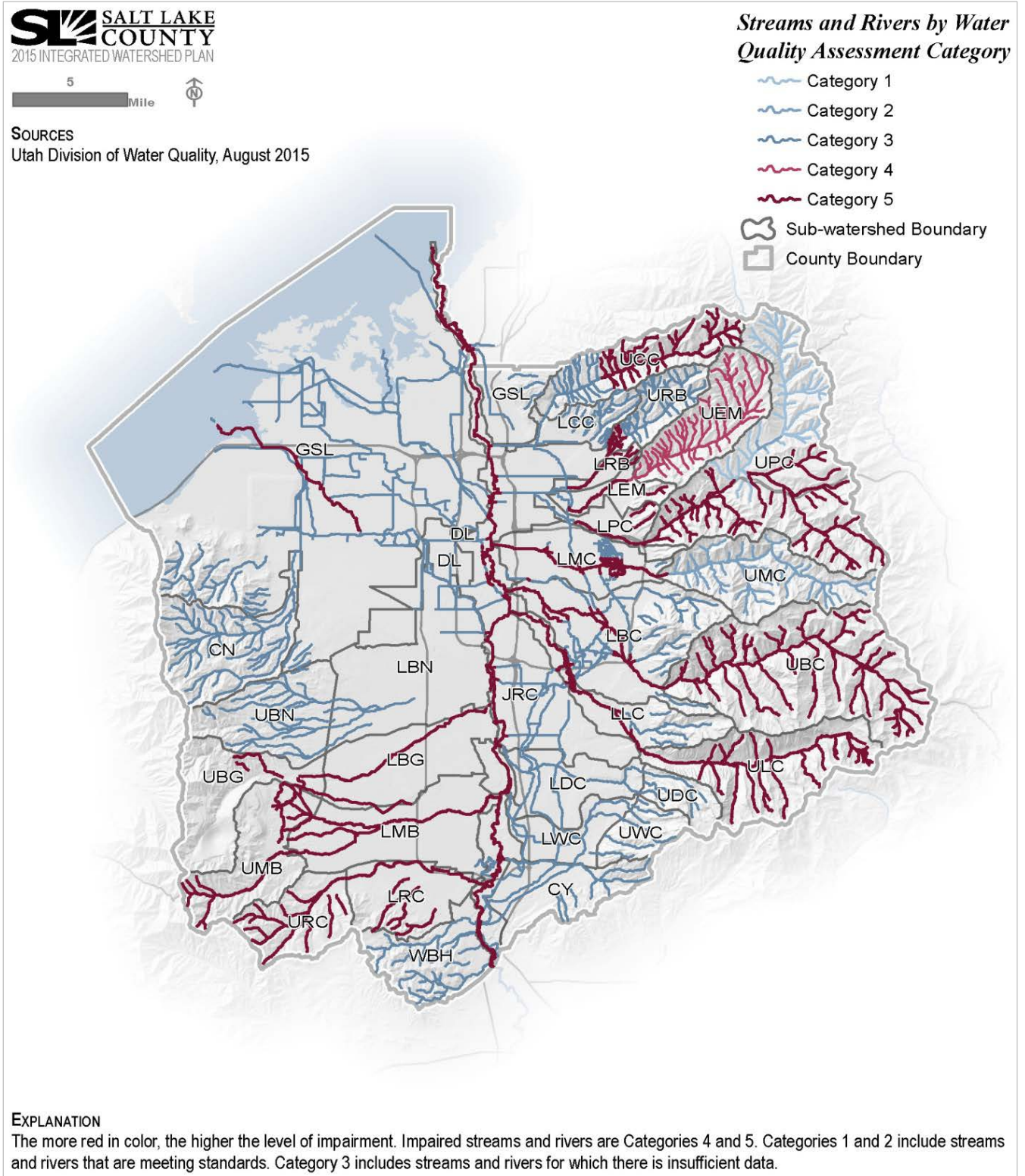

Currently, six waterbodies have insufficient data available to evaluate whether beneficial uses are supported. These include waterbodies in the upper Dry Creek, lower City Creek, and upper Red Butte Creek sub-watersheds, transitional wetlands and open waters of Farmington Bay and Gilbert of the Great Salt Lake in Salt Lake County. Because of the lack of data, these waterbodies are listed as Category 3.

If a specific surface water is determined to have pollutants that exceed the water quality standards, the State designates it as an *impaired waterbody* and placed on a list called a *303(d) list*. Waterbodies classified in UDWQ's draft 2014 Integrated Report as Category 4 or 5 are impaired, and are listed in Table 3-4.

UDWQ then provides a long-term plan for completing TMDLs within 8 to 13 years from each water's first listing. As of the winter of 2015–2016, the draft Integrated Report is going through the EPA approval process, so some data could change.

TMDLs for the lower Jordan River (Dissolved Oxygen --phase 1), Emigration Creek (*E.coli*) and Little Cottonwood Creek (zinc) have been developed, approved and are currently being implemented. The lower Jordan TMDL Phase 1 study, approved by EPA in 2013, indicated an organic matter load reduction of 38% was necessary to meet dissolved oxygen water quality standards. This load reduction was further defined into a load allocation requiring a 35% reduction and a waste load allocation requiring 41% of organic matter. The phased TMDL schedule calls for implementation in 2018 of stormwater improvements and implementation in 2023 for point source improvements.

In the 2009 Plan, 11 waterbody segments, totaling about 86.5 stream miles, were reported as listed as impaired (these data were taken from UDWQ's 2006 Integrated Report). The County's review of UDWQ's 2014 draft Integrated Report shows that the number of impaired waterbody segments in the Salt Lake countywide watershed has significantly increased, with 23 waterbody segments, totaling about 150 stream miles (not including tributaries to the mainstem waterbody) listed in the 2014 draft Integrated Report as impaired. Most (19) of the sub-watersheds have more than 25% of their streams categorized as impaired under the Clean Water Act. Of these, 16 have a rate of more than 75% impaired. Table 3-4 shows that some of the recurring causes of impairment are *E. coli*, aquatic habitat condition as indicated by observed-to-expected bioassessments, total dissolved solids, and metals such as cadmium.

Table 3-4. Impaired Waterbodies in Salt Lake County (2014)

UDWQ Waterbody Segment	Impaired Stream Miles ^a	Location (downstream to upstream limits)	Assessment Unit Subcategory: Cause of Impairment (TMDL Priority/Status ^b)	Beneficial-Use Class
Big Cottonwood Creek – 1	10.008	Creek and tributaries from Jordan River to Big Cottonwood water treatment plant	<i>E. coli</i> (M) Observed to Expected (OE) bioassessment (L)	2B, 3A, 4
Big Cottonwood Creek – 2	44.452	Creek and tributaries from Big Cottonwood Water Treatment Plant (WTP) to headwaters	Cadmium (L) Copper (L)	1C, 2B, 3A
Bingham Creek	4.395	Creek and tributaries from confluence with Jordan River to headwaters	Selenium (L) Total dissolved solids (L)	2B, 3D, 4
Butterfield Creek	6.17	Creek and tributaries from confluence with Jordan River to headwaters	<i>E. coli</i> (M) Selenium (L) Total dissolved solids (L)	2B, 3D, 4
City Creek – 2	6.454	Creek and tributaries from filtration plant to headwaters	Cadmium (L)	1C, 2B, 3A
Emigration Creek Upper	3.509	Creek from stream gage at Rotary Glen Park above Hogle Zoo to headwaters	<i>E. coli</i> (Approved)	2B, 3A, 4
Emigration Creek Lower	1.258	Creek and tributaries from 1100 East to stream gage at Rotary Glen Park above Hogle Zoo	<i>E. coli</i> (M)	2B, 3A
Jordan River – 2	6.076	Salt Lake County line upstream to North Temple	<i>E. coli</i> (M), OE bioassessment (L) Dissolved oxygen (Approved)	2B, 3B, 3D, 4
Jordan River – 3	2.701	North Temple to 2100 South	OE bioassessment (L) Dissolved oxygen (Approved)	2B, 3B, 4
Jordan River – 4	5.699	2100 South to the confluence with Little Cottonwood Creek	<i>E. coli</i> (M) Total dissolved solids (H) OE bioassessment (L)	2B, 3B, 4
Jordan River – 5	4.487	the confluence with Little Cottonwood Creek to 7800 South	Temperature (H) Total dissolved solids (H)	2B, 3A, 4
Jordan River – 6	12.716	7800 South to Bluffdale at 14600 South	Dissolved oxygen (M) Selenium (L) Temperature (H) Total dissolved solids (H)	2B, 3A, 4
Jordan River – 7	4.375	Bluffdale at 14600 South to Narrows	OE bioassessment (L) Temperature (H)	2B, 3A, 4
Jordan River – 8	About 1.0	Narrows to Salt Lake County boundary	Arsenic (M) Total dissolved solids (H)	1C, 2B, 3B, 4
Lee Creek	5.167	Creek at Interstate 80 (I-80) crossing	Total dissolved solids (L)	2B, 3D, 4
Little Cottonwood Creek – 1	8.809	Creek and tributaries from Jordan River confluence to Metropolitan WTP	<i>E. coli</i> (M) OE bioassessment (L) Cadmium (M) Temperature (L) Total dissolved solids (L)	3A, 3B, 4
Little Cottonwood Creek – 2	27.633	Creek and tributaries from Metropolitan WTP to headwaters	Cadmium (M) Copper (M) pH (M) Zinc (Approved)	1C, 2B, 3A
Mill Creek – 1	0.861	Creek from confluence with Jordan River to Interstate 15 (I-15) crossing	Dissolved oxygen (M) <i>E. coli</i> (M) OE bioassessment (L)	2B, 3, 3C

Table 3-4. Impaired Waterbodies in Salt Lake County (2014)

UDWQ Waterbody Segment	Impaired Stream Miles ^a	Location (downstream to upstream limits)	Assessment Unit Subcategory: Cause of Impairment (TMDL Priority/Status ^b)	Beneficial-Use Class
Mill Creek – 2	7.998	Creek and tributaries from I-15 to U.S. Forest Service boundary	<i>E. coli</i> (M) OE bioassessment (L)	2B, 3A, 4
Parley's Canyon Creek – 1	13.601	Creek and tributaries from 1300 East to Mountain Dell Reservoir	<i>E. coli</i> (H) OE bioassessment (L)	1C, 2B, 3A
Parley's Canyon Creek – 2	15.745	Creek and tributaries from Mountain Dell Reservoir to headwaters	Cadmium (L)	1C, 2B, 3A
Red Butte Creek Lower	2.185	Creek and tributaries from 1100 East to Red Butte Reservoir	OE bioassessment (L)	2B, 3A, 4
Rose Creek	7.026	Creek and tributaries from confluence with Jordan River to headwaters	<i>E. coli</i> (M)	2B, 3D, 4

Source: UDWQ 2014, Chapter 5. For more information, go to <http://waterquality.utah.gov/>.

^a Impaired stream miles are based on stream segments and tributaries identified and measured by UDWQ. These stream reaches and their lengths are different from the main stem stream reaches associated with the sub-watersheds and listed in Table 3-1.

^b (L) – TMDL priority low; (M) – TMDL priority medium; (H) – TMDL priority high; (Approved) – TMDL Approved

Antidegradation and High-Quality Waters

The State of Utah has designated certain waterbodies as “high-quality waters” in accordance with UAC R371-2, Standards of Quality for Waters of the State, Section R317-2-3, Antidegradation Policy. The antidegradation policy classifies waters into three categories.

- **Category 1 waters** are waters of high quality with exceptional recreational or ecological significance, or that require protection. Designated Category 1 waters must be maintained at existing high quality. New point-source discharges are prohibited in segments of Category 1 waters, and diffuse sources must be controlled to the extent feasible through implementation of best management practices or regulatory programs.
- **Category 2 waters** are designated surface water segments that are treated as Category 1 waters except that a point-source discharge may be permitted provided that the discharge does not degrade existing water quality.
- All other waters of the state are **Category 3 waters**. For Category 3 waters, the State allows point-source discharges, and degradation may occur pursuant to the conditions and review procedures in Section 3.5 of R317-2-3.

Waterbodies in the countywide watershed that have been designated as Category 1 waters are identified in Table 3-5. All Category 1 waters are in east-side upper sub-watersheds that have headwaters in the Wasatch Mountains. There are no Category 2 waters in Salt Lake County.

Table 3-5. Category 1 High-Quality Waters in Salt Lake County

Sub-watershed	Waterbody	Location
Upper City Creek	City Creek	City Creek and tributaries, from City Creek WTP to headwaters (Salt Lake County)
Upper Emigration Creek	Emigration Creek	Emigration Creek and tributaries, from Hogle Zoo to headwaters (Salt Lake County)
Upper Red Butte Creek	Red Butte Creek	Red Butte Creek and tributaries, from Foothill Boulevard in Salt Lake City to headwaters
Upper Parley's Creek	Parley's Creek	Parley's Creek and tributaries, from 1300 East in Salt Lake City to headwaters
Upper Mill Creek	Mill Creek	Mill Creek and tributaries, from Wasatch Boulevard in Salt Lake City to headwaters
Upper Big Cottonwood	Big Cottonwood Creek	Big Cottonwood Creek and tributaries, from Wasatch Boulevard in Salt Lake City to headwaters
Upper Willow Creek	Willow Creek	Little Willow Creek and tributaries, from diversion to headwaters (Salt Lake County)
Upper Dry Creek	Bell Canyon Creek	Bell Canyon Creek and tributaries, from Lower Bells Canyon Reservoir to headwaters (Salt Lake County)
Upper Dry Creek	Dry Creek	South Fork of Dry Creek and tributaries, from Draper Irrigation Company diversion in to headwaters (Salt Lake County)

Source: UAC R317-2-12.1 (as in effect July 1, 2015)

Municipalities and Townships

Salt Lake County government is comprised of 16 incorporated cities (municipal governments) and unincorporated county areas which are governed solely by the County. The unincorporated areas have been defined into six townships and other unincorporated areas. For the purposes of this 2015 Plan, the unincorporated county is defined as the *other* areas that are *not* included in a township. The municipalities, townships, and unincorporated county areas of Salt Lake County are shown in Figure 3-6 and listed in Table 3-6.

Figure 3-6. Municipalities and Townships in Salt Lake County

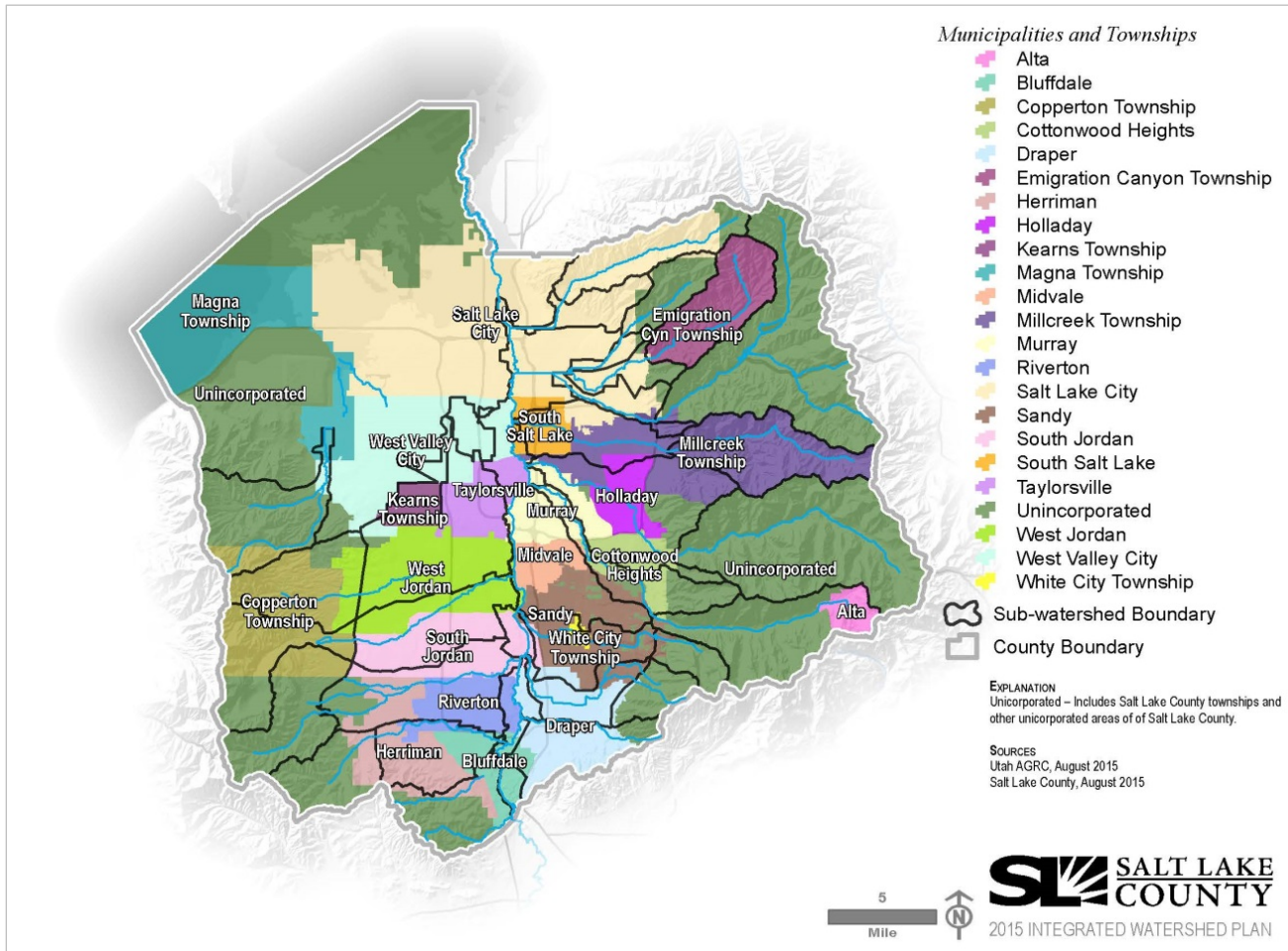

Source: Salt Lake County 2015

Table 3-6. General Characteristics of Local Jurisdictions in Salt Lake County

Jurisdiction	2010 Population ^{a,b}	Area (sq. miles) ^c	Streams and Rivers	
Town of Alta	383	4.6	Upper Little Cottonwood Creek	
Bluffdale City	7,598	10.3	Corner Canyon Creek Jordan River	Midas/Butterfield Creek Lower Rose Creek
Cottonwood Heights City	33,433	9.4	Lower and upper Big Cottonwood Creek	Lower Little Cottonwood Creek
Copperton Township	826	33.1	Upper Barney's Creek	
Draper City	40,532	22.1	Corner Canyon Creek Jordan River	Lower Dry Creek Lower and upper Willow Creek
Emigration Township	1,567	18.2	Burr Fork	Lower and upper Emigration Creek
Herriman City	21,785	20.7	Jordan River Lower Midas/Butterfield Creek	Lower Rose Creek
Holladay City	26,472	8.5	Lower Big Cottonwood Creek	Lower Mill Creek
Kearns Township	35,731	4.6	None	
Magna Township	26,505	37.5	Coon Creek Great Salt Lake of Salt Lake County Harkers Creek	Kersey Creek Lee Creek
Midvale City	27,964	5.8	Jordan River	Lower Little Cottonwood Creek
Millcreek Township	62,139	40.4	Jordan River Lower and upper Mill Creek	Lower Parley's Creek
Murray City	46,746	12.3	Barneys Creek Jordan River Lower Big Cottonwood Creek	Lower Little Cottonwood Creek Lower Mill Creek
Riverton City	38,753	12.6	Jordan River Lower Midas/Butterfield Creek	Lower Rose Creek
Salt Lake City	186,440	111.7	Jordan River Lower and upper City Creek Lower and upper Emigration Creek	Lower Mill Creek Lower and upper Parley's Creek Lower and upper Red Butte Creek
Sandy City	87,461	23.6	Jordan River Lower and upper Dry Creek	Lower and upper Little Cottonwood Crk Lower and upper Willow Creek
South Jordan City	50,418	22.3	Lower Bingham Creek Jordan River Lower Dry Creek	Lower Willow Creek Lower Midas/Butterfield Creek
South Salt Lake City	23,617	6.9	Jordan River Lower Big Cottonwood Creek	Lower Mill Creek
Taylorsville City	58,652	10.8	Lower Barney's Creek Decker Lake	Jordan River Lower Big Cottonwood Creek
City of West Jordan	103,712	32.3	Lower Barney's Creek Lower Bingham Creek	Jordan River
West Valley City	129,480	35.4	Lower Barney's Creek Coon Creek	Decker Lake Jordan River
White City Township	5,407	0.9	None	
Balance of Salt Lake County (other unincorporated areas, excluding townships)	14,034	321	Jordan River Lower and upper City Creek Lower and upper Emigration Creek Lower and upper Mill Creek Lower and upper Parley's Creek Lower and upper Big Cottonwood Crk Lower and upper Little Cottonwood Crk	Corner Canyon Wood and Beef Hollow Lower and upper Rose Creek Lower and upper Midas/Butterfield Crk Lower and upper Bingham Creek Great Salt Lake
Salt Lake County total	1,029,655	805		

^a Source: U.S. Census Bureau 2013

^b Townships are unincorporated areas managed by Salt Lake County as defined places. The U.S. Census Bureau collects data for these areas as Census designated places (CDPs), which the Census Bureau defines as settled concentrations of population that are identifiable by name but are not legally incorporated under the laws of the state in which they are located.

^c Sources: AGRC 2015 for city boundaries; Salt Lake County 2015 for township boundaries

Other Jurisdictions and Land-Management Agencies

Multiple federal, state, and local agencies have jurisdiction over watershed health and/or water quality in Salt Lake County. These agencies are regulatory agencies, water- and land-management agencies, and municipal governments. The agencies in each category are listed below along with their specific water quality or watershed health authority.

Regulatory Agencies. The following federal and state agencies have regulating authority within Salt Lake County:

- **U.S. Army Corps of Engineers** – permitting agency for activities that fill jurisdictional waters of the U.S. as defined in Clean Water Act Section 404.
- **U.S. Federal Emergency Management Agency** – identifies and manages areas in designated flood hazard areas.
- **U.S. Environmental Protection Agency** – responsible for activities covered under the Clean Water Act and Safe Drinking Water Act.
- **Utah Division of Water Quality** – responsible for permitting surface and groundwater discharges; establishes water quality standards for beneficial-use protections.
- **Utah Division of Water Rights** – determines and oversees water right appropriations and stream alteration permitting. Manages water diversions into and out of the Jordan River for water rights and water-management purposes.
- **Utah Division of Water Resources** – evaluates and protects water resources.
- **Utah Division of Wildlife Resources** – protects wildlife in the countywide watershed.

Water- and Land-Management Agencies. The following federal and state agencies have water- or land-management jurisdiction over federal and state waters or lands, respectively, within Salt Lake County:

- **U.S. Forest Service** – management agency for about 79,000 acres of the Uinta-Wasatch-Cache National Forest that are within the county.
- **U.S. Bureau of Land Management** – management agency for about 2,400 acres that are within the county, by agreement with the U.S. Forest Service.
- **Utah Division of Forestry, Fire and State Lands** – manages State of Utah sovereign lands (land below a designated high water line and within the meander line for the Jordan River and the Great Salt Lake, respectively) for the public trust.
- **Utah Division of Parks and Recreation** – manages three state parks within the county (Great Salt Lake Marina, Jordan River OHV [off-highway vehicle] State Recreation Area and Modelport, and This Is the Place Heritage Park).
- **Utah Division of Water Rights** – manages water diversions into and out of the Jordan River for water rights and water-management purposes. Regulates water right diversions.
- **Jordan River Commission** – voluntary organization of governmental and nongovernmental organizations. Facilitates regional coordination and implements planning, restoration, and development projects along the Jordan River.

Municipal Governments. The following municipal governments and agencies have jurisdiction over lands for the purposes of maintaining water quality or managing water resources within Salt Lake County:

- **Salt Lake City and Sandy City** – have extraterritorial jurisdiction for drinking water source headwaters and watershed protection in areas of the Wasatch Mountains within Salt Lake County.
- **Municipalities and Salt Lake County (in unincorporated areas)** – have land use jurisdiction within their boundaries and are responsible for permitting and managing stormwater discharges to receiving waters.
- **Special service districts** – provide water and wastewater utilities within district boundaries and manage permitted discharges to and water right diversions from receiving waters.
- **Salt Lake County Flood Control** – manages and maintains countywide flood-control facilities.
- **Salt Lake Valley Health Department** – enforces water quality discharges as a result of spills and illicit discharges.

3.2 Population and Land Use

The analysis presented in this section evaluates expected changes in population and land use between 2011 and 2040, and how these changes might affect water quality conditions.

2009 Plan Population Analysis

The 2009 Plan analyzed changes in population between 2005 and 2030 to provide information about changes in populations by sub-watershed. This method helped the County identify sub-watersheds where the predicted changes in populations could threaten water quality the most, since increasing population results in increases in infrastructure, housing, and businesses. Salt Lake County was predicted to grow from 970,612 residents in 2005 to 1,381,519 residents in 2030. The Jordan River corridor and Barney's Creek sub-watersheds were forecasted to have the highest populations in 2030.

Sub-watershed Population Estimates

Consistent with the 2009 Plan, this update focuses on characterizing sub-watershed areas. Understanding the density of populations living and forecasted to live in each sub-watershed can help inform policy development and decision-making.

Population projections prepared by the Governor's Office of Management and Budget for the period 2010 and 2040 show that annual average growth is expected to range from less than 1 percent in areas that are mostly built out (such as Salt Lake City, Sandy, Holladay, and West Valley City) to more than 4 percent in areas that can accommodate continued residential development (such as Bluffdale and Herriman). The Wasatch Front Regional Council (WFRC) estimates current population and projects future population in its service area, which includes Salt Lake County. The WFRC's current population forecasts for Salt Lake County estimate population change up to the year 2040, based on traffic analysis zone (TAZ) units in the county.

The WFRC does not generally project population for remote areas of the county, including some areas in canyons on the west and east sides of the county. For the 2015 Plan, remote area projections were estimated by using the 2009 Plan’s rate of growth and extrapolating the data to 2040.

For areas where the WFRC projects population by TAZ, city and township population projections are determined by aggregating TAZ-based data as appropriate. For example, when an entire TAZ is within a city or sub-watershed (referred to as a *target unit*), the population projection for that TAZ is included in the population projection for the target unit.

What is a traffic analysis zone (TAZ)?

A TAZ is a geographical unit used in transportation planning models. Various socioeconomic data, such as population, are available for each TAZ

The projections for all TAZs within that target unit are added together to create a unit-based population. When a TAZ crosses a unit boundary (that is, does not lie entirely within one city, township, or sub-watershed), the population for that TAZ is not included in the total population projection for the target unit.

Population density (persons per acre) is estimated using the unit-based population projections. Density calculations assume an even distribution of population across the unit being studied, whether the unit is a city or a sub-watershed. For example, the density estimate for a 1,000-acre area with a combined TAZ population projection of 25,000 people would be 25 people per acre for the entire area being evaluated.

This 2015 Plan uses 2011 as the base year because the WFRC used it as the base year for its population projections. Table 3-7 shows the population estimates, population densities, and expected change between 2011 and 2040 for the sub-watersheds in the county.

Overall, the WFRC projects that the total population of Salt Lake County will change from 1,033,523 people to 1,492,884 people by 2040, which is an increase of about 460,000 people. Table 3-7 and Figure 3-8 show the projected sub-watershed-based change in population density and percent change in population density, respectively. In each figure, the analysis shows the relative comparison of the sub-watersheds. Looking at absolute change shows that the more-developed watersheds on the valley floor and lower sub-watersheds are projected to be home to an additional 50,001 to 100,000 people by 2040. The exception is the Decker Lake watershed, which is projected to increase by less than 1,000 people by 2040.

Some of the areas with larger projected absolute increases in population (more than 50,000 people) would have an increase in population density (people per acre) of 100% or more. These sub-watersheds—upper Barney’s Creek, lower and upper Bingham Creek, lower and upper Midas/Butterfield Creek, and upper Rose Creek—are all in the southwestern part of the county.

Mountainous east-side sub-watersheds are not projected to substantially increase in population density (they would increase by 10% or less), mostly because of limited changes in land use (they would mostly remain open space). Lower east-side sub-watersheds are projected to have some increases in population density, but the changes are generally expected to be lower than those on the west side. The Jordan River corridor and Great Salt Lake sub-watersheds are projected to have relatively moderate changes in population density, with increases of 30% and 41%, respectively.

Changes in population (absolute numbers and densities) are directly related to land use, which is discussed in the following section. All of these elements need to be considered together in order to paint a complete picture of how conditions might change over time and to indicate areas that are priority targets for water quality management efforts.

Table 3-7. Salt Lake County Sub-watershed Population Change (2011 - 2040)

Sub-watershed	Population Counts			Population Density (persons per acre)			
	2011	2040	Change	2011	2040	Change	% Change
Upper Barneys Creek (UBN)	2,697	53,051	50,354	142	2,792	2,650	1867
Lower Barneys Creek (LBN)	149,708	202,552	52,844	4,738	6,410	1,672	35
Upper Big Cottonwood Creek (UBC)	384	387	3	8	8	0	1
Lower Big Cottonwood Creek (LBC)	86,573	91,840	5,267	2,740	2,906	167	6
Upper Bingham Creek (UBG)	674	7,557	6,883	36	400	364	1021
Lower Bingham Creek (LBG)	50,920	137,867	86,947	2,460	6,660	4,200	171
Upper City Creek (UCC)	1,584	1,547	-37	91	89	-2	-2
Lower City Creek (LCC)	12,423	14,278	1,855	1,725	1,983	258	15
Corner Canyon Creek (CY)	16,484	20,591	4,107	1,129	1,410	281	25
Decker Lake (DL)	62,668	63,347	679	6,461	6,531	70	1
Upper Dry Creek (UDC)	229	223	-6	38	37	-1	-3
Lower Dry Creek (LDC)	48,136	56,061	7,925	3,592	4,184	591	16
Upper Emigration Creek (UEM)	709	706	-3	39	39	0	0
Lower Emigration Creek (LEM)	21,152	20,520	-632	3,647	3,538	-109	-3
Great Salt Lake of Salt Lake County (GSL)	127,610	179,937	52,327	1,053	1,485	432	41
Coon Creek (CN)	4,582	8,411	3,829	203	372	169	84
Jordan River Corridor (JRC)	206,037	267,721	61,684	3,733	4,850	1,117	30
Upper Little Cottonwood Creek (ULC)	966	950	-16	36	35	-1	-2
Lower Little Cottonwood Creek (LLC)	30,307	33,256	2,949	2,386	2,619	232	10
Upper Midas/Butterfield Creek (UMB)	261	3,498	3,237	13	179	166	1240
Lower Midas/Butterfield Creek (LMB)	54,123	143,351	89,228	2,156	5,711	3,555	165
Upper Mill Creek (UMC)	369	368	-1	17	17	0	0
Lower Mill Creek (LMC)	72,132	73,691	1,559	4,746	4,848	103	2
Upper Parley's Creek (UPC)	983	982	-1	19	19	0	0
Lower Parley's Creek (LPC)	21,509	22,188	679	3,361	3,467	106	3
Upper Red Butte Creek (URB)	362	360	-2	43	43	0	-1
Lower Red Butte Creek (LRB)	9,303	9,064	-239	3,578	3,486	-92	-3
Upper Rose Creek (URC)	3,463	13,508	10,045	251	979	728	290
Lower Rose Creek (LRC)	23,772	37,953	14,181	1,617	2,582	965	60
Upper Willow Creek (UWC)	168	167	-1	24	24	0	-1
Lower Willow Creek (LWC)	21,493	25,096	3,603	2,286	2,670	383	17
Wood and Beef Hollow (WBH)	1,742	1,856	114	114	121	7	7
Totals	1,033,523	1,492,884	459,361				

Source: WFRC 2015

Figure 3-8. Projected Percent Change in Population Density by Sub-watershed (2011 - 2040)

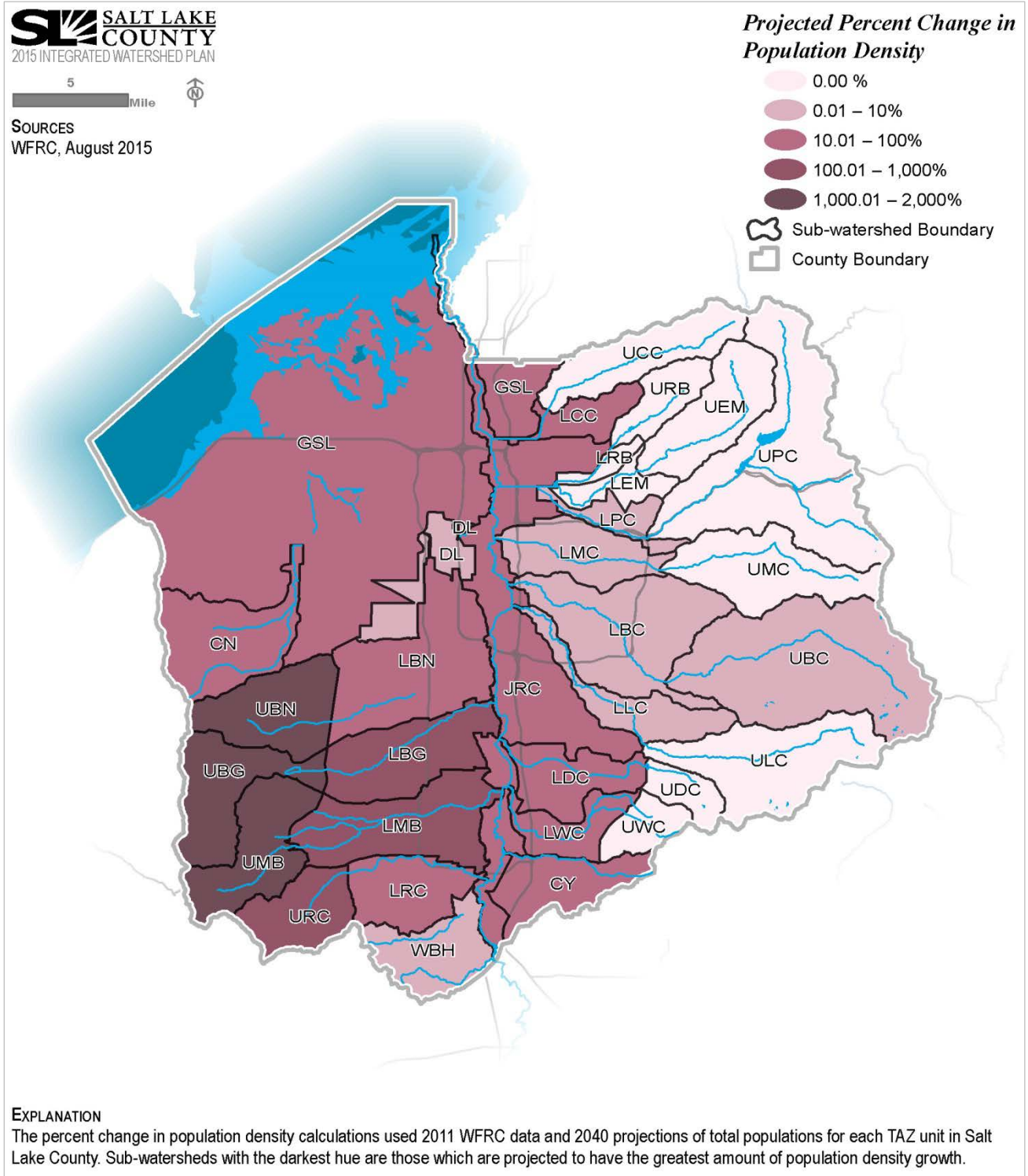

Land Use

Land use is an important factor contributing to existing and projected water quality conditions of surface waters.

Analyzing existing and future land use data helps to identify where predicted changes in land use—that result in more impervious areas and less open spaces, factors that together result in more stormwater runoff—could threaten water quality the most.

Increased imperviousness can impact water quality the following ways: (1) reduced groundwater recharge; (2) increased volume of stormwater discharges; (3) increased runoff into streams that could increase flood potential and erosion, thereby affecting the aquatic habitat; and (4) increased urban pollutants discharged to streams by stormwater runoff. With the expansion of urban development into previously undeveloped areas and increasing population densities, Salt Lake County expects the amount of impervious surface area throughout the county to increase.

2009 Plan Land Use and Imperviousness Analysis

The 2009 Plan analyzed changes in land use based on review and analysis of the County’s existing land use dataset (created in 2000) and WFRC’s Future Land Use GIS Dataset (through 2030), which were used to develop consolidated land use categories. This analysis helped the County identify sub-watersheds where the predicted changes in land use could threaten water quality the most by creating more impervious areas and less open spaces.

The 2009 Plan identified those sub-watersheds with the most change in impervious areas. This enabled the County to prioritize potential water quality improvements that could minimize future land use-related threats to water quality. The land use data analyzed for the 2009 Plan forecasted that the county as whole would have an additional 5,429 acres, or 3.7%, of impervious areas by 2030.

The six sub-watersheds identified in the 2009 Plan as having the greatest expected increase in imperviousness were: Midas/Butterfield Creek (20.9% increase), lower Emigration Creek (17.1%), lower Mill Creek (14.7%), the Jordan River corridor (14.2%), Barney’s Creek (11.7%), and lower Parley’s Creek (11.3%).

What is imperviousness?

Imperviousness, or percent impervious surface area, is a measure of the level of development and water-infiltration capacity in an area. For example, an aspen forest (low percent impervious) allows greater infiltration of water into the ground than does a paved parking lot (high percent impervious).

What are consolidated land use categories?

Local municipalities define land use for areas within their jurisdictions. These local land uses vary in names and numbers. To ensure that the various land use datasets used are compatible, land use categories are consolidated, combined, and/or grouped into similar general land use categories based on their impervious characteristics.

2015 Plan Land Use Projections

The 2015 Plan followed the same land use and imperviousness analysis that was conducted in the 2009 Plan. The WFRC’s current existing and future land use plans were gathered and the many existing and planned land use categories were combined into the same eight consolidated land use categories used in 2009, with one exception. This update added a new “Mixed-Use Residential” category, due to the abundance of mixed-uses land uses planned by local jurisdictions.

Table 3-8 summarizes the expected changes in the consolidated land use categories between 2011 and 2040. Figure 3-9 and Figure 3-10 show the existing and future land use categories, respectively.

Table 3-8. Projected Changes in Land Use in Salt Lake County (2011 - 2040)

Land Use Category	Area (sq. mi.)		Change, 2011 - 2040	
	2011	2040	Area (sq.mi.)	Percent (%)
Commercial	23.97	28.64	4.37	18
Industrial	98.40	87.23	-11.56	-12
Public/Institutional	59.57	53.28	-6.29	-11
Mixed Use Residential ^a	13.35	38.12	24.59	184
Residential	129.81	141.64	11.74	9
Open Space / Agricultural / Park	87.63	65.60	-22.03	-25
Forest / Wetlands / Salt Flats	306.70	305.89	-0.82	0
Water	29.65	29.65	0.00	0
Road	56.88	55.91	0.00	0

Source: WFRC 2015

^a new category for 2015 Plan

Figure 3-9. Existing Land Uses in Salt Lake County (2011)

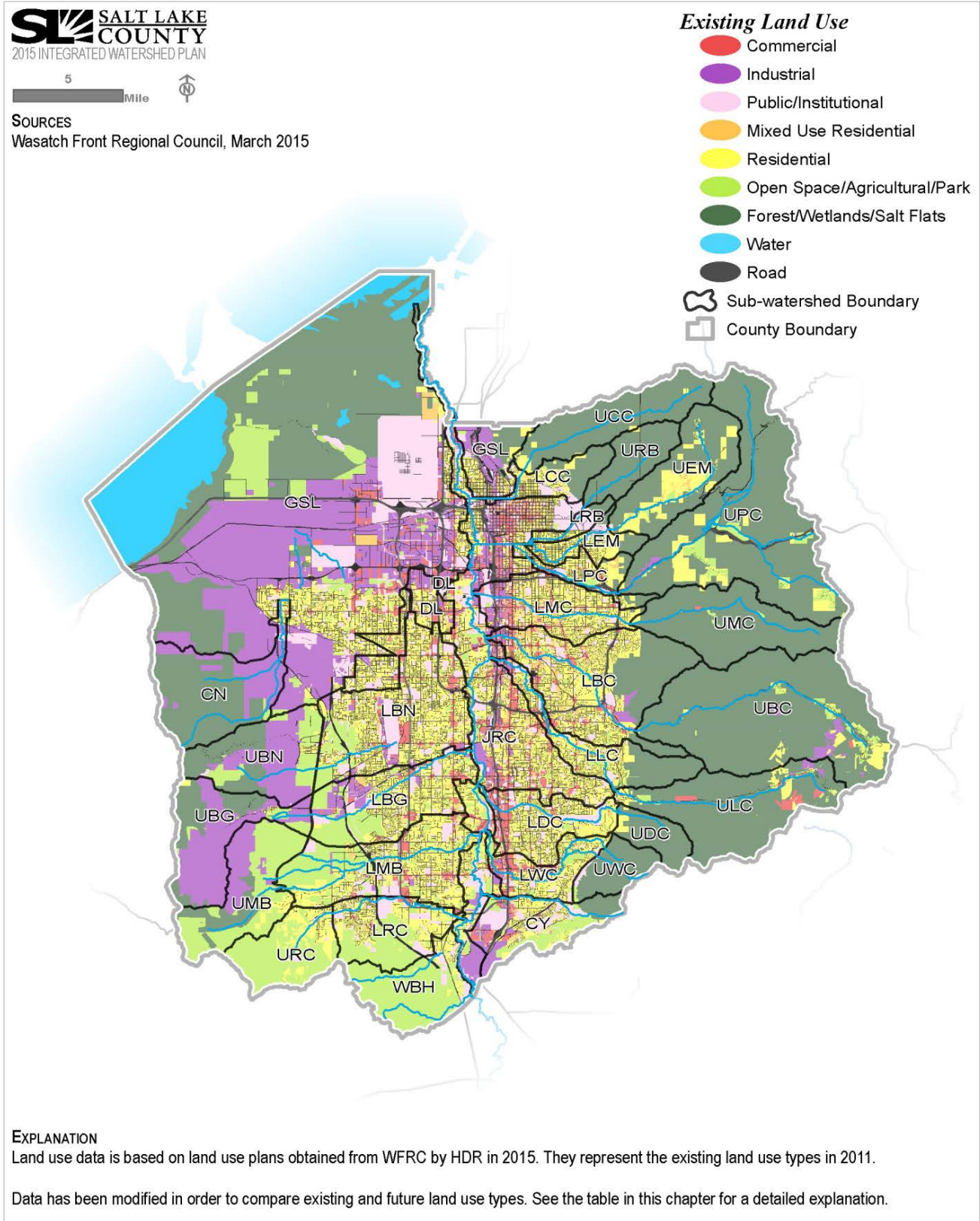
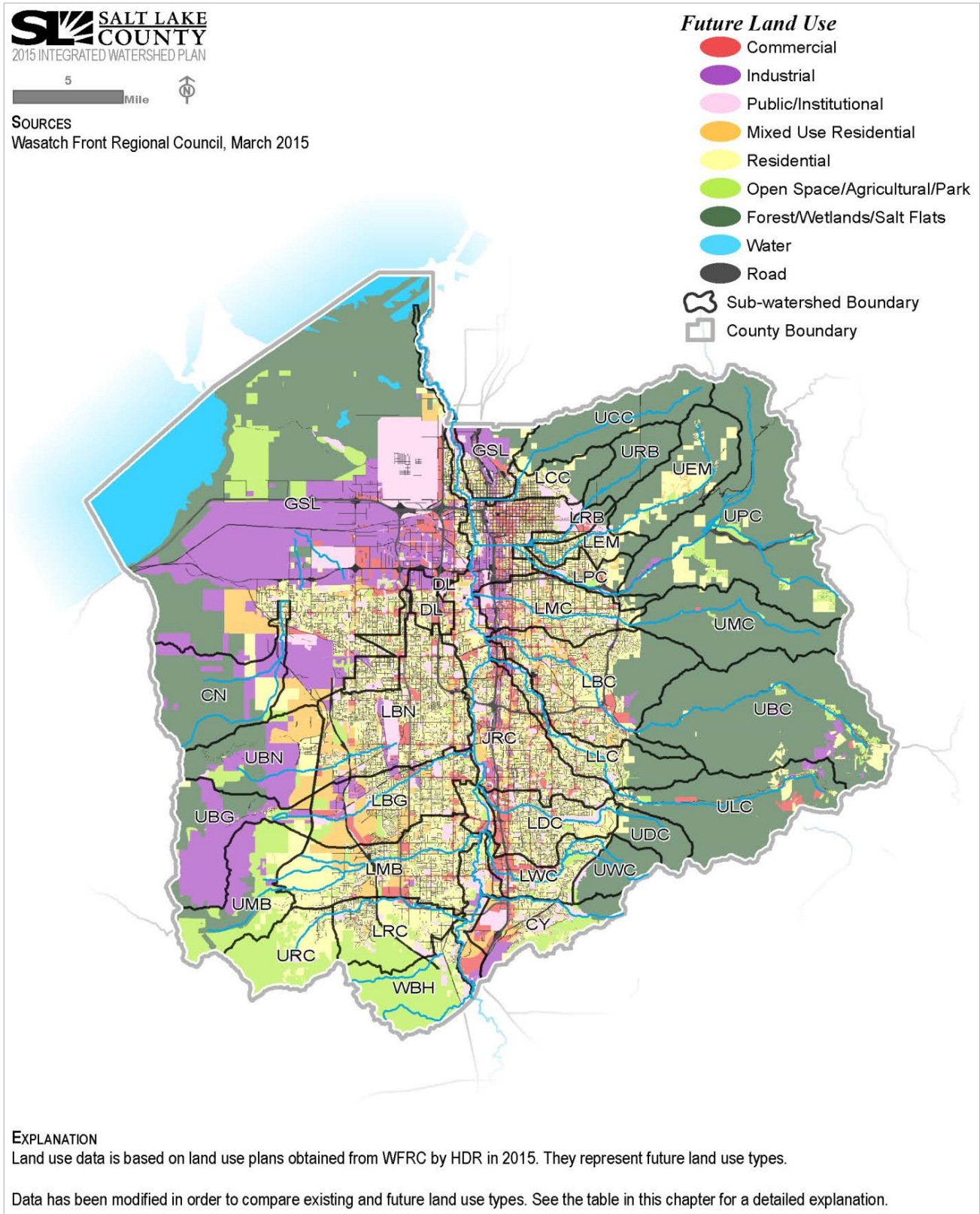

Figure 3-10. Projected Future Land Uses in Salt Lake County (2040)



Imperviousness

The County analyzed the 2015 land use information shown in Table 3-9 to predict impervious surface area within each sub-watershed and the anticipated change due to changes in land uses between 2011 and 2040.

Identifying areas of higher potential change can help the County identify management and development strategies to minimize future water quality impacts related to increases in impervious surfaces. Impacts to water quality from increased stormwater discharges, as predicted from changes in land use, are discussed in Section 4.1, Stormwater Discharges.

All land use categories (with the exception of Water) were related to measurements of percent impervious surface area, which is an indicator of the amount of development within the area of each land use (see Table 3-9).

Table 3-9. Impervious Surface Area Factor Per Land Use Category

Land use Category ^a	Impervious Surface Area Factor ^b
General Category: Commercial	85%
<i>Sub-categories:</i> Hotel Flex-Space Employment Metropolitan Center Town Center Office Main Street Commercial Strip Commercial Urban Center Retail Big Box Suburban Office District Urban Office District Commercial	
General Category: Forest / Wetland / Salt Flats	9%
<i>Sub-category:</i> Public	
General Category: Industrial	72%
<i>Sub-categories:</i> Heavy Industrial Light Industrial	
General Category: Mixed-Use Residential [NEW category for 2015 Plan]	59%^c
<i>Sub-categories:</i> Mixed Use Compact Neighborhood Downtown Neighborhood Station Community Boulevard Community Main Street Community Town Neighborhood Urban Neighborhood	
General Category: Parks / Agriculture / Open Space	12%
<i>Sub-categories:</i> Agricultural Open Space	
General Category: Public/Institutional	51%
<i>Sub-categories:</i> Education Public Utilities	
General Category: Residential	32%
<i>Sub-categories:</i> Mobile Homes Large Lot Single Family Small Lot Single Family Large Lot Single Family Multi-Family Housing Medium Lot Single Family Townhouse Single Family Subdivision	
General Category: Transportation	85%
<i>Sub-category:</i> Roads	

^a Similar land use designations were consolidated based on their impervious characteristics.

^b Source: NRCS 1986

^c This impervious factor is an average of the Natural Resources Conservation Service (NRCS) commercial and residential factors to account for more green space than in typical commercial areas and less green space than in typical residential areas.

On a sub-watershed level, the County computed the weighted average proportion (percentage) of impervious area by land use category for existing and future land use data sets. The average weighted existing impervious area was compared to future average weighted impervious area to determine the change for the entire county and each sub-watershed (Figure 3-11). Current and future consolidated land use data show that, generally, the county's urban areas and areas that are expected to grow significantly by 2040 will have an increase in the area of impervious surfaces.

The future average weighted impervious factor for the entire county watershed is forecasted to increase by 3.6 percentage points, resulting in about 4,900 more impervious acres in the county, for a countywide weighted average impervious surface area factor of 32.52%. The analysis takes into account both positive and negative changes in imperviousness. Increases are a result of changing a land use type from a category that is more pervious to one that is less pervious as well as increases in the amount of acreage of impervious land use types. Decreases are a result of a substantial change in the forecasted land use to a use type that is more pervious (that is, has a lower impervious surface area factor).

As illustrated in Figure 3-11, most of the county is projected to have little (5% or less) or no increase in imperviousness between 2011 and 2040. Most sub-watersheds are projected to have a decrease or no change in acreage of industrial land uses, a land use type with 72% impervious surface area. In most cases, the industrial areas are projected to change to residential uses, which has a lower impervious surface area factor (59% for mixed-use residential and 32% for residential). This influences the overall rates of change in many of the watersheds, keeping the expected change at less than 5%. However, for the 18 watersheds that show a projected increase in imperviousness, this is mostly the result of open space-type land uses changing to mixed-use residential or commercial. The Coon Creek sub-watershed, in contrast, shows a substantial projected overall reduction in impervious area due to industrial land uses converting to residential. In Coon Creek the overall projected change in imperviousness is negative.

Figure 3-11 also shows a concentrated area of projected increase in imperviousness in the southwestern quadrant of the county. As discussed in the Sub-watershed Population Estimates section, some of the sub-watersheds in this same area are expected to have the most substantial increases in population density. Considered together, this information can help the County and its partner cities develop water quality projects that can take the expected increases in imperviousness and population in this geographical area into account.

Figure 3-11. Change in Impervious Surface Area by Sub-watershed (2011 - 2040)

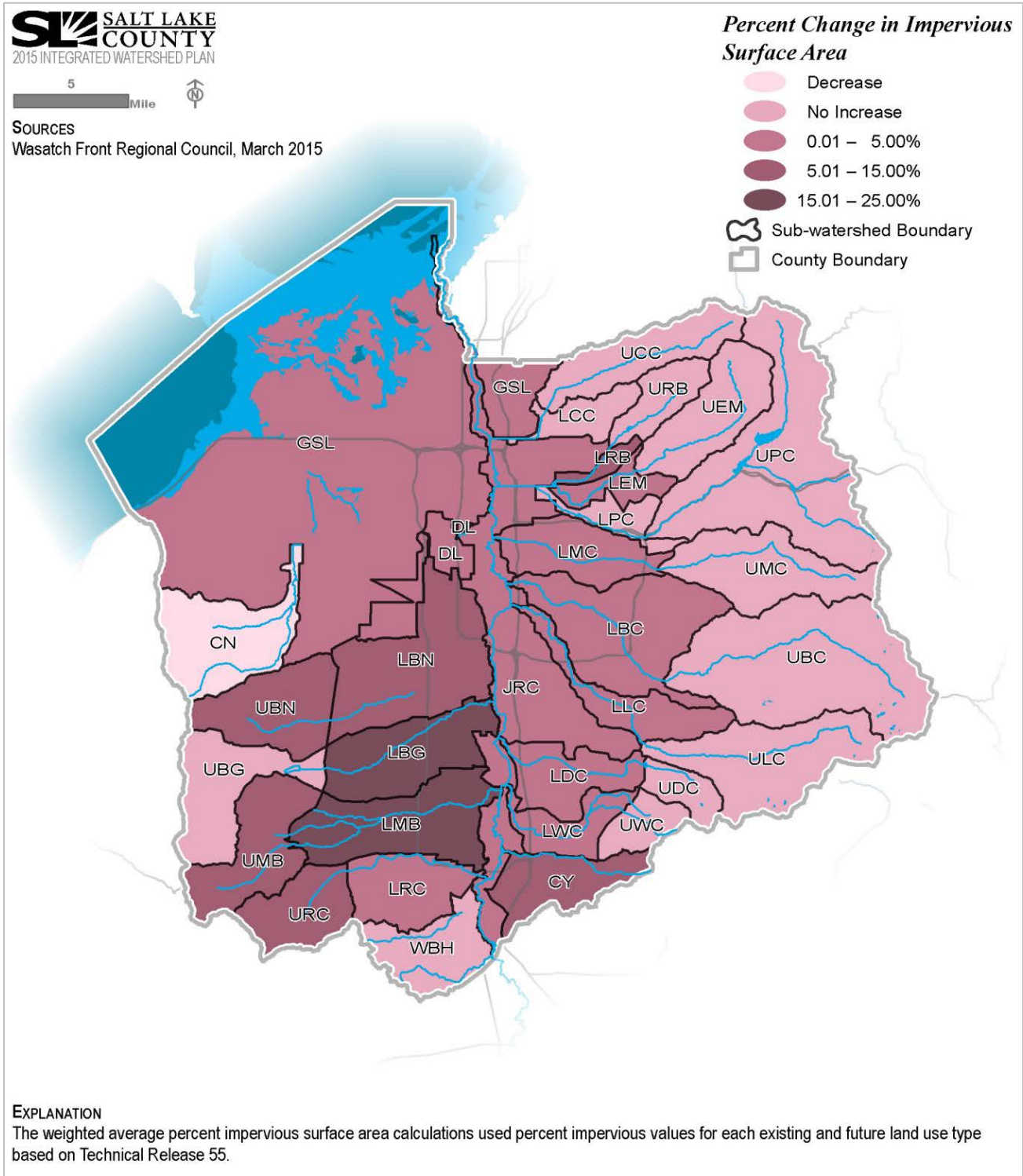

3.3 Social and Recreation Functions

Salt Lake County's watersheds serve multiple purposes for residents and visitors, purposes including social, recreation, and aesthetic functions. Individual behaviors within the county affect these functions as well as other watershed functions such as water quality, habitat, and hydrology. The County seeks to understand these functional interactions because human behaviors can determine the success of managing watersheds and improving water quality conditions.

This plan update focuses on how land use, open space in particular, might affect water quality between 2011 and 2040. This update also provides a summary of public opinion about the county's watersheds.

2009 Plan Social and Recreation Analyses

The 2009 Plan inventoried and analyzed recreation in both the urban and mountain sub-watersheds of the county, with the rationale that watersheds provide opportunities for recreational activities that can affect water quality. The recreation visits and opportunities documented in the plan included about 1.4 million winter visitors (total) to the mountain resorts in Big and Little Cottonwood Canyons, about 465 urban parks, about 400 miles of paved and dirt trails, 12 private duck-hunting clubs, and about 30 golf courses.

The 2009 Plan also included an analysis of access to public recreation opportunities on a sub-watershed basis. The results indicated that, generally, the northern and eastern parts of the county provided more access to public land than did the western part due to the large amount of publicly managed (U.S. Forest Service) land within the eastern sub-watersheds compared to the large amount of private land in the western sub-watersheds.

Public Opinion about the County's Watersheds

The Salt Lake County Watershed Planning and Restoration Program conducted public opinion surveys in 2007, 2010, and 2015 to gauge public attitudes about watersheds, land use, water quality, public policy, and outdoor recreation (SLCO 2007; SLCO 2010; SLCO 2015). For each survey, the poll is conducted with 400 phone interviews with residents, leading to a 95% confidence level for the survey results.

The questions asked in the three surveys were designed so that attitude trends could be analyzed. Most attitudes have not changed significantly among the three surveys, though some opinions and knowledge have changed slightly. Overall, the surveys found that:

- Salt Lake County residents like to get outdoors, and they place a great value on outdoor recreation. The proportion of surveyed residents who say that outdoor activities are very important to their overall quality of life has ranged from 59% to 64%.
- The demand for outdoor recreational activities was significantly higher in 2015 than it was in 2007, and the percentage of responding residents who want to see less urban development decreased from 64% to 53% between 2007 and 2010, and has held steady there.

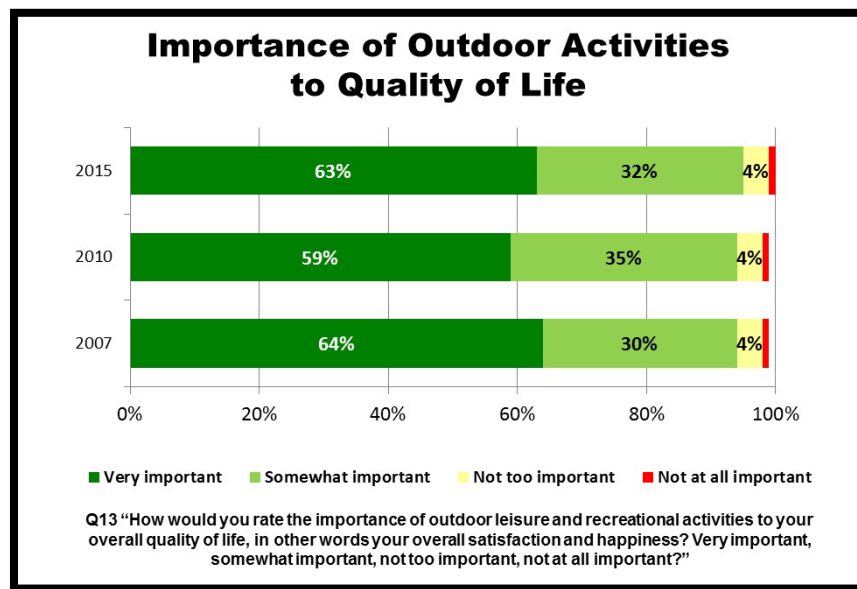

Source: SLCO, 2015

- County residents are conservation-minded. In both 2010 and 2015, nearly 90% of residents surveyed rated their commitment to conservation as average to strong.
- More than 60% of surveyed residents are at least somewhat familiar with water quality concerns in the county. For watershed values, residents overwhelmingly value water quality the highest. Having an adequate supply of good drinking water has consistently been residents' top concern.
- When asked to grade the health of the Jordan River, residents generally view the river's health as poor. Big Cottonwood Creek is viewed as being healthier, as are other urban streams and creeks that are close to where the respondents live.
- Most residents do not know that the Jordan River is impaired. In 2015, nearly 80% of surveyed residents were unaware; this is a substantial increase from 2010, when about 60% of residents responded that they did not know the river is impaired.
- Residents generally do not support lowering water quality to promote economic development and think that a healthy economy depends on good water quality.
- About 44% of the surveyed residents agree that their activities affect water quality, while 32% disagree and 23% don't know. Although the proportion of residents who say that their activities affect water quality is not substantial, awareness in 2015 has improved over the awareness levels in 2007 and 2010.

Comparing Changes in Water Quality Attitudes

“Using a 1 to 5 scale, this time with 1 meaning you ‘strongly disagree’ and 5 meaning you ‘strongly agree,’ please tell me whether you agree or disagree with the following statements.”

	2007 Mean	2010 Mean	2015 Mean
Sometimes it is okay to lower the water quality in the watershed to promote economic development.	1.67	2.10	1.89
A healthy economy depends on good water quality in the watershed.	4.07	3.91	4.18
My activities affect the water quality of Salt Lake County's watersheds.	2.64	2.57	3.18

Expressed as a mean; higher numbers mean stronger agreement.

Source: SLCO, 2015

- Residents’ desire to provide land for wildlife habitat has held steady during all three surveys, as has their interest in preserving river corridors in their natural condition after a slight dip in 2010. Open space that is protected from development was of greater interest to the public in 2015 than it was in 2007.
- Residents generally favor public policies such as requirements for leaving natural vegetation in place near rivers to protect and improve water quality, and most respondents support more public funding to protect local waters.
- In the 2015 survey, the public’s strong support for water protection, and the great value Salt Lake County residents place on the outdoors, are reflected in their willingness to support additional funding for water-protection efforts. In a general sense, “if county leaders said more public funding was needed to protect our local waters,” a resounding 82% of residents would support more public funding if the amount was “reasonable,” as shown on the graphic below.

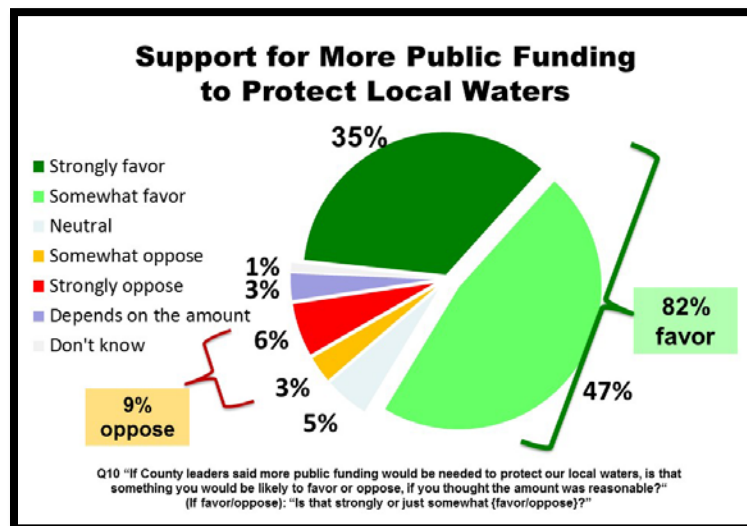

Source: SLCO, 2015

The 2015 survey concludes with the observation that the public in Salt Lake County

... values the outdoors, enjoys spending time in the county's wild places, and wants more protection of waters and open spaces. There is some awareness of water quality problems in local creeks and rivers, though the awareness could be much higher, and there is wide variety of opinion about whether one's own actions impact water quality. Nonetheless, the public exhibits a strong will to address water quality, supporting specific public policy proposals and funding mechanisms that would promote healthier waters. (SLCO 2015)

Recreation, Open-Space Areas, and Water Quality

The results of the public opinion surveys indicate that residents appreciate and are aware of the importance of open space and the recreation opportunities that open space provides. Recognizing and managing for residents' desire for open space, and the recreation that goes along with it, can also provide opportunities for water quality protection. At the most basic level, undeveloped open space provides areas that can naturally filter more stormwater and reduce more runoff compared to more-developed areas. For example, open space has an impervious factor (9% to 12%) that is much lower than commercial areas (85%) and even residential areas (32%) (see Table 3-10).

In the 2009 Plan, the County compared the proportion of open space for existing and future land use data sets on a sub-watershed level. The 2015 Plan repeats and updates this comparison. For this type of analysis, *open space* is defined as a combination of the land use categories of forest, wetlands, salt flats, open space, agriculture, and parks.

Figure 3-12 shows the projected loss in open space by sub-watersheds based on the change from existing (2011) land uses to expected future (2040) land uses. Sub-watersheds with greater losses could potentially have greater adverse water quality effects associated with the loss of open space.

Figure 3-12. Projected Decrease in Open-Space Area by Sub-watershed (2011 - 2040)

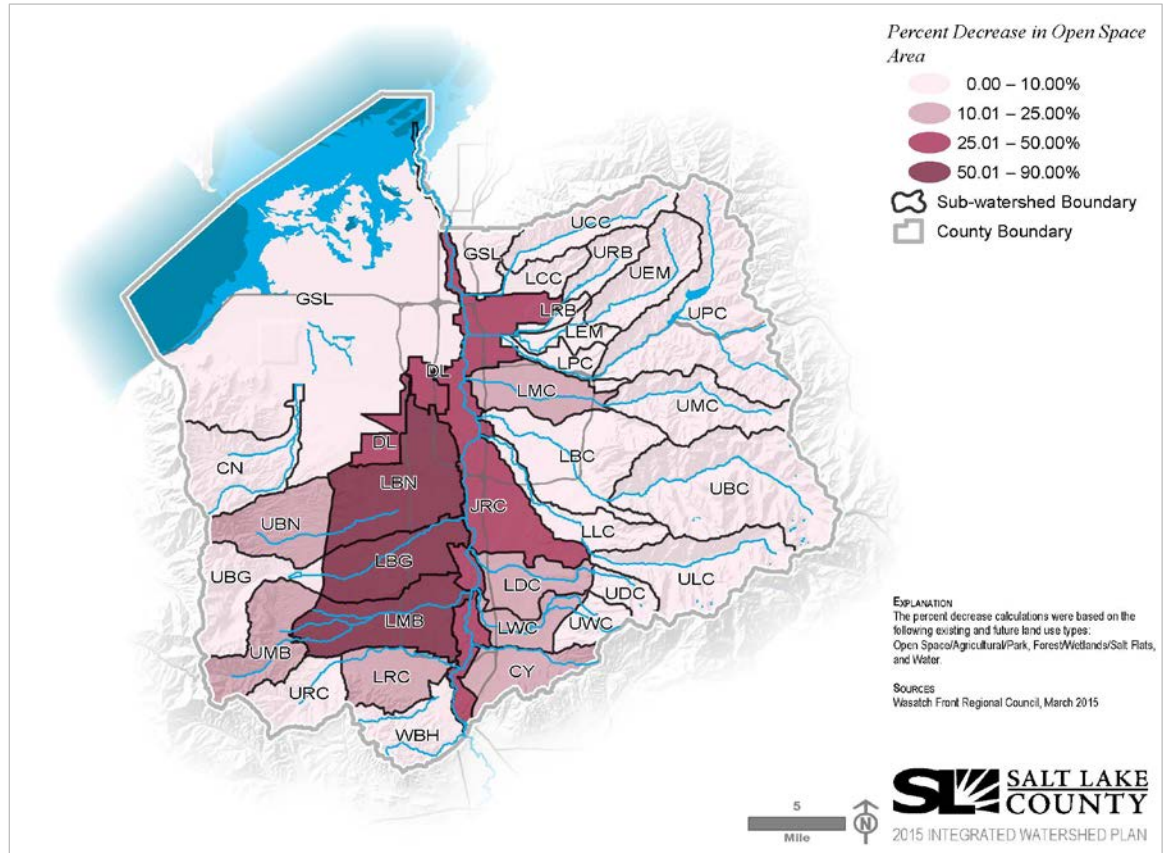

Figure 3-12 shows that most of the upper east-side sub-watersheds, many of which comprise a large proportion of publicly owned land, are projected to have very little decrease in the percentage of open space. Five sub-watersheds are projected to lose more than 25% of designated open space between 2011 and 2040 due to changes in land use, three of which are projected to lose more than 50% (lower Barney's Creek, Bingham Creek, and Midas/Butterfield Creek). The sub-watersheds with higher projected loss of open space correspond to those that are also projected to have the highest increases in population density (Figure 3-7) and the largest increases in impervious area (Figure 3-11).

The public opinion surveys included a question that addresses residents' awareness of whether and how their behavior might affect water quality. The results of the 2010 survey show that, by a factor of almost 2 to 1, residents did not believe that their own recreation activities affected the county watershed. The results of the 2015 survey indicate that residents are becoming more aware of how their activities might affect water quality.

3.4 Environmental Justice Populations and Water Quality

Incorporating environmental justice in water quality project planning considers whether that project would have disproportionate adverse effects on populations that have historically borne the environmental effects of development.

The federal government uses an executive order to guide how it defines and evaluates potential effects on environmental justice populations; that executive order focuses on low-income and minority populations.

Some states and local jurisdictions have expanded their environmental justice programs to include senior citizens and people with disabilities. In all cases, the focus is to ensure that environmental justice populations have a voice during project planning and implementation and that they are not subject to disproportionate, adverse environmental effects of a given project.

The State of Utah and Salt Lake County do not have adopted policies or programs that define environmental justice populations or that address environmental justice considerations during project planning and construction. All county populations, including those that the federal executive order considers to be environmental justice populations, are protected by environmental regulations, including the federal Clean Water Act and federal Clean Air Act; Utah Administrative Code sections that address resources such as air quality, water quality, water supply, and flood control; and the County Code of Ordinances sections that address health and safety, buildings and construction, flood control and water quality, and zoning.

For this 2015 Plan, Salt Lake County has identified environmental justice populations to help ascertain situations where those populations might be subject to disproportionate adverse effects as well as situations where environmental conditions could be improved. For example, the County could implement water quality improvement projects in areas with a concentration of minority residents who have historically borne adverse environmental water quality effects from past and existing land uses that produce high levels of pollutants (such as industrial uses that operated before the state and federal governments established regulations that protect water quality).

This section summarizes and compares the distribution of low-income and minority residents in the county's sub-watersheds, based on U.S. Census Bureau data, for the purposes of developing water quality improvement projects and planning outreach.

The County could conduct additional analyses when designing specific projects and implementing outreach. These analyses could include focused environmental justice evaluations regarding community information, such as assistance provided through churches and cultural

What is environmental justice?

Environmental justice is the fair treatment and meaningful involvement of all people regardless of race, color, national origin, or income with respect to environmental effects of development (EPA, 2016)

What are environmental justice populations?

For this 2015 Plan, environmental justice populations are people who are low-income (living in poverty), minority, or both.

groups; analyses about the location and extent of areas that have historically been polluted, such as Superfund sites; and analyses of areas with public services in need of significant rehabilitation, such as areas that are known to be blighted. For these analyses, the County might use tools such as EPA’s EJSCREEN mapping tool (ejscreen.epa.gov/mapper) and the U.S. Census Bureau’s American FactFinder database (factfinder.census.gov/faces/nav/jsf/pages) to collect information about environmental, income, and housing conditions in a geographic area.

Methods for Identifying Low-Income and Minority Populations

Data collected by the U.S. Census Bureau provide an overall picture of where low-income and minority populations live and how they are distributed in a specific geographic area. Environmental justice analyses that follow the federal guidance typically start by reviewing Census Bureau data about income, poverty, race, and Hispanic or Latino/Latina populations. The Census Bureau collects data about people of Hispanic or Latino/Latina ethnicity separately from race because Hispanic and Latino/Latina people can be one of several races or a combination of races.

Depending on what these Census Bureau data show, an analysis can also consider data about people who receive supplemental income, such as Social Security and disability income; people who receive public assistance, such as food stamps; children who receive free or reduced-price lunches in public schools; and people who receive housing assistance, such as Section 8 housing.

For the purposes of this 2015 Plan, the County collected Census Bureau information about income, poverty, race, and people of Hispanic and Latino/Latina origin. The data provide information by *block group*, which is a statistical subdivision of a census tract. Block groups contain between 600 and 3,000 people and are the smallest geographic unit for which the Census Bureau tabulates data. The County merged GIS (geographic information systems) data provided by the Census Bureau with the sub-watershed boundaries to identify the areas in the county that might contain environmental justice populations. The County can then use this information to make extra efforts to engage residents when planning water quality improvement projects.

For **income**, the analysis of environmental justice populations compares the proportion of people living in poverty within each sub-watershed to the proportion within the county as a whole. This analysis uses Census Bureau data that provide a measure of the percentage of people living in poverty. Depending on the situation and application, people who are not living in poverty as defined by the Census Bureau or U.S. Department of Housing and Urban Development can still be considered *low income*. For example, a local public assistance program might use specific definitions for very-low-, low-, and moderate-income households for the purpose of identifying the level of aid a household might need. This 2015 Plan uses poverty as an income measure and is not intended to provide a definitive measure of all low-income households in the county.

For **minorities**, the analysis of environmental justice populations uses Census Bureau data about the proportion of minorities within each sub-watershed, where *minorities* are defined as the combined proportion of people who are Black or African American, American Indian or Alaska Native, Asian, Native Hawaiian or other Pacific Islander, some other race, or two or more races. For people of Hispanic or Latino/Latina origin, the analysis uses Census Bureau data for people who identify as Hispanic or Latino/Latina regardless of race. The analysis compares the proportion of minorities within each sub-watershed to the proportion within the county as a whole.

The results show how each sub-watershed generally compares to countywide conditions and to the conditions of other sub-watersheds. The results show patterns of population distributions that can be used as a starting point for environmental justice considerations.

Low-Income Residents

The Census Bureau establishes poverty income thresholds based on the number of people living in a household. In 2013, the countywide median income for Salt Lake County was \$60,555, and the average household size was three people. The Census-designated national poverty threshold for a household with three people was \$18,552. Data from the 2013 American Community Survey show that **12.7% of the population in Salt Lake County lives in poverty** (for those whom poverty status had been determined). The proportion of children under 18 years of age living in poverty was higher than the overall countywide proportion, with 16.2% of children in the county living in poverty.

Figure 3-13 shows the proportion of people living in poverty by sub-watershed and indicates whether that proportion is higher or lower than the countywide proportion of 12.7%.

The Census Bureau data show that the Decker Lake sub-watershed has the highest rate of poverty compared to other sub-watersheds, and the rate of poverty in that sub-watershed is higher than that of the county as a whole. The Jordan River corridor, Great Salt Lake, and lower City Creek sub-watersheds also have poverty rates that are higher than that of the county as a whole. When considered together, these four sub-watersheds form a contiguous high-poverty-level area that traverses the county from north to south along the Jordan River.

Minority Residents

In 2013, 15.4% of county residents were Black or African American, American Indian or Alaska Native, Asian, Native Hawaiian or other Pacific Islander, some other race, or two or more races. Within this minority population, the largest proportion identified as some other race (5.4%). People who identify with this category are often Hispanic or Latino/Latina and don't feel that they belong to one of the other race categories that the Census Bureau considers. The Census Bureau recognizes that survey respondents can be confused by questions about race and that cultural, political, and geographic components influence the answers. The Census Bureau continues to work on better ways to ask questions about race.

Overall, Utah and Salt Lake County are predominantly white (Salt Lake County was 84.6% white in 2013), with very small proportions of racial minorities. However, the proportion of people who identified as some other race in 2013 (5.4%) was much lower than the countywide proportion of people who identified as Hispanic or Latino/Latina (17.2%). The proportions of people who identify as Hispanic or Latino/Latina provide another indication of the distribution of minority populations in Salt Lake County.

Figure 3-14 shows the proportions of racial minorities by sub-watershed and indicates whether each sub-watershed proportion is higher or lower than the countywide proportion of 15.4%

Figure 3-13. Distribution of People Living in Poverty in Salt Lake County by Sub-watershed

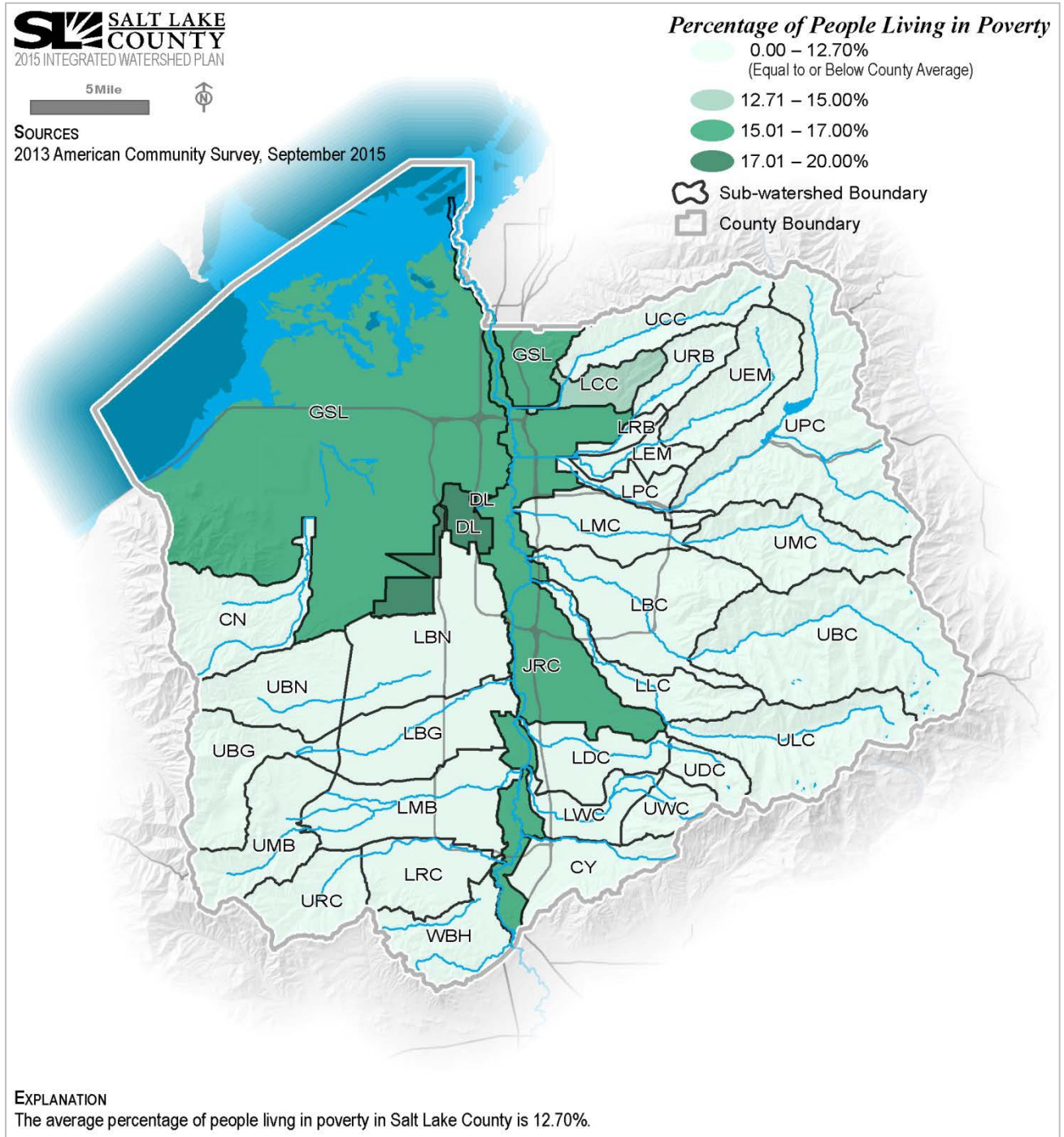
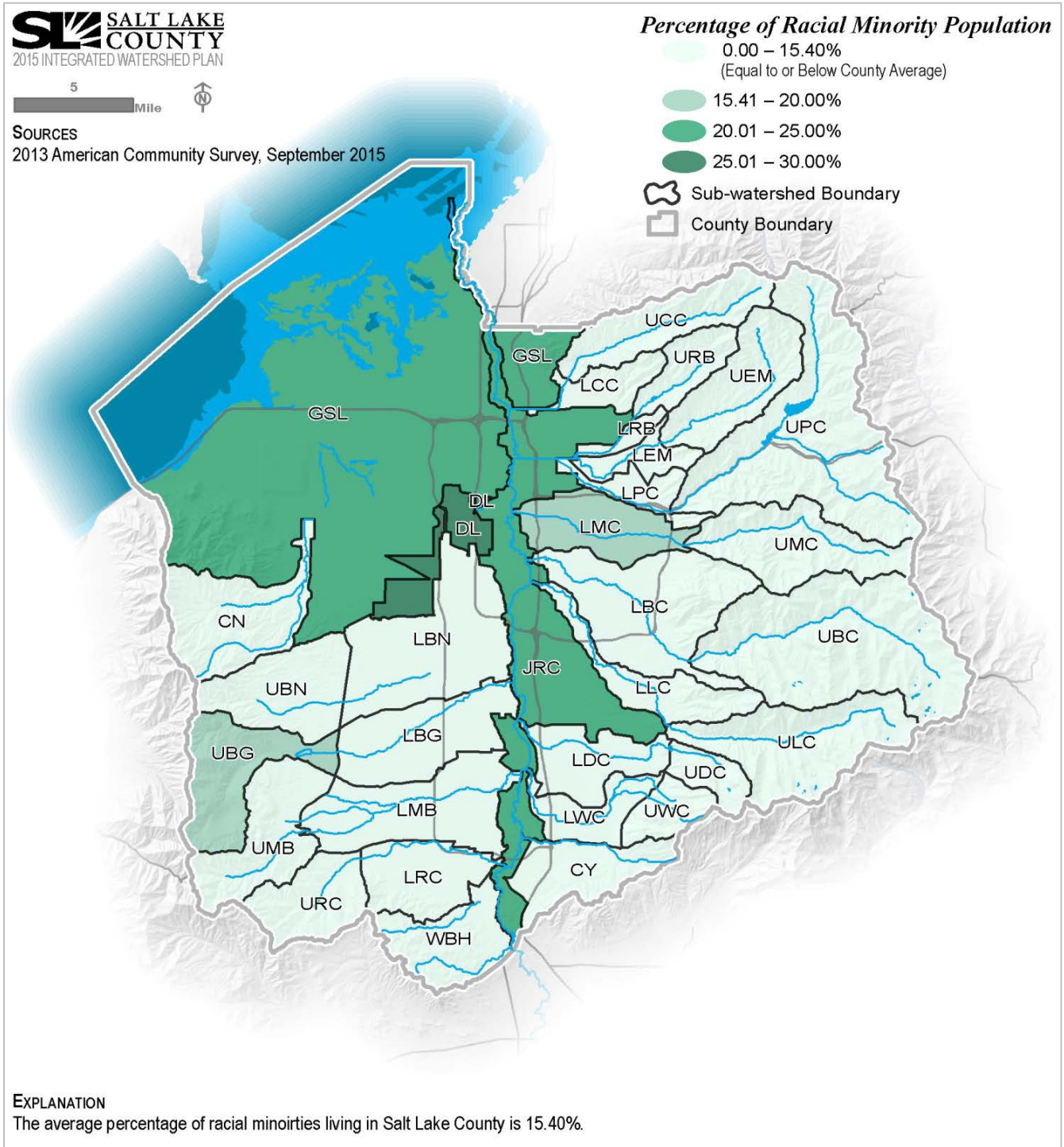

Figure 3-14. Distribution of Racial Minorities in Salt Lake County by Sub-watershed



The Census Bureau data show that five sub-watersheds have proportions of racial minorities that are higher than that of the county as a whole: Great Salt Lake, Decker Lake, Jordan River corridor, lower Mill Creek, and upper Bingham Creek. Three of these sub-watersheds also support proportions of people living in poverty that are higher than that of the county: Great Salt Lake, Decker Lake, and Jordan River corridor.

Figure 3-15 shows the distribution, by sub-watershed, for people who identify as Hispanic or Latino/Latina compared to the countywide proportion of 17.2%.

Figure 3-15. Distribution of People Who Identify as Hispanic or Latino/Latina, Regardless of Race by Sub-watershed

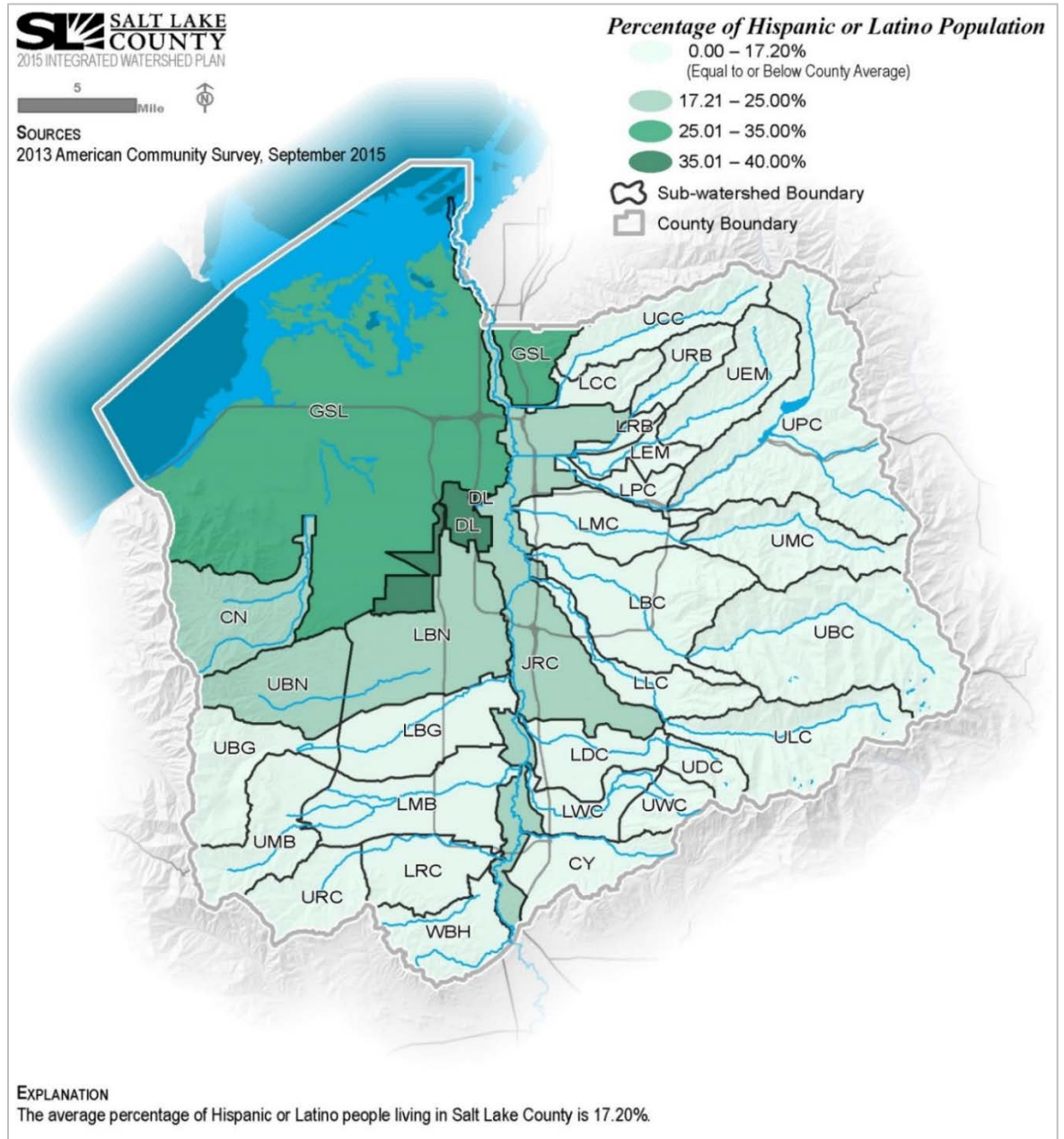

The Census Bureau data show a more extensive distribution of Hispanic and Latino/Latina minorities than of racial minorities. Three sub-watersheds have proportions of racial minorities and Hispanic and Latino/Latina minorities that are higher than the county proportions: Great Salt Lake, Decker Lake, and Jordan River corridor. As noted in the discussion following Figure 3-14 above, these three sub-watersheds also support proportions of people living in poverty that are higher than the county proportion. Other sub-watersheds that have proportions of Hispanic or Latino/Latina residents that are higher than the county proportion are Coon Creek, lower Barneys Creek, and upper Barneys Creek.

Summary

Salt Lake County examined U.S. Census Bureau data to understand the countywide distribution of low-income and minority populations. The County used Census Bureau data about poverty, race, and Hispanic or Latino/Latina ethnicity to determine the status of each sub-watershed and to compare the sub-watersheds to overall county proportions of low-income and minority populations. The data show that:

- The contiguous area of the Great Salt Lake, Decker Lake, and Jordan River corridor sub-watersheds has poverty rates, proportions of racial minorities, and proportions of Hispanic and Latino/Latina people that are higher than the countywide proportions.
- The lower City Creek sub-watershed has a proportion of people living in poverty that is higher than the countywide proportion but lower than the proportions for the Great Salt Lake, Decker Lake, and Jordan River corridor sub-watersheds.
- The lower Mill Creek and upper Bingham Creek sub-watersheds have proportions of racial minorities that are higher than the countywide proportion but lower than the proportions for the Great Salt Lake, Decker Lake, and Jordan River corridor sub-watersheds.
- The Coon Creek, lower Barneys Creek, and upper Barneys Creek sub-watersheds have proportions of Hispanic and Latino/Latina residents that are higher than the countywide proportion. The proportion of Hispanic and Latino/Latina residents for these three sub-watersheds is the same as the proportion for the Jordan River corridor but is lower than the proportions for the Great Salt Lake and Decker Lake sub-watersheds.

3.5 Water Quality

This section focuses on Salt Lake County’s water quality data collection program and provides water quality condition summaries for total dissolved solids (TDS), pH, dissolved oxygen (DO), temperature, *E. coli*, and macroinvertebrates. Also summarized are recent and historic water quality monitoring conducted along the Jordan River by UDWQ to support regulatory programs.

2009 Plan Summary of Water Quality Conditions

The 2009 Plan summarized the beneficial uses of waters in Salt Lake County, listed the high-quality waters in the county, identified the Clean Water Act Section 303(d)-listed waterbodies and the types of impairments, discussed water quality trends related to total phosphorus and total dissolved solids (TDS), discussed stormwater pollutant loads, and discussed other pollutant discharges and nonpoint source (NPS) discharges.

In addition to the general discussion of water quality conditions, the County developed and implemented a rapid stream assessment tool to inventory and assess four stream functions—habitat, hydraulics, water quality, and social/recreation—called the Stream Function Index (SFI). In all, the County evaluated 245 miles of streams and 44 miles of the Jordan River using the SFI methodology.

Specific to the water quality function, the SFI identified the need for a greater body of water quality data in order to more completely and accurately assess the condition of waterways in Salt Lake County, which reflects on the overall health of the watershed. In particular, the following data were identified as necessary to improving the reliability of the SFI results: stream flow, *E.coli*, macroinvertebrates, physical habitat, and water chemistry (SLCO 2010).

Introduction to Water Quality Data Collection Programs

To address the lack of baseline water quality data identified in the 2009 Plan, an expanded data collection program was implemented by the County Watershed Planning and Restoration Program in 2009, and included:

- Installation of new stream flow gage stations
- Macroinvertebrate & physical habitat sampling
- *E.coli* sampling
- Water chemistry data collected at all sampling sites
- Stream stability study (started in 2015)

Routinely monitoring water quality allows Watershed Planning personnel to analyze stream segments where watershed conditions, as reflected by the water quality data, appear to be changing and identify potential areas of concern where watershed and/or water quality improvement projects can occur.

What stream types are sampled as part of the County’s data-collection program?

Perennial streams normally have water in the stream channel at all times.

Intermittent streams flow only when they receive water from rainfall runoff or from springs or from a surface source such as melting snow.

Ephemeral streams flow only in direct response to precipitation; they receive little or no water from springs, melting snow, or other sources. Their channels are at all times above the water table.

Table 3-10. Salt Lake County Water Quality Period of Record for Selected Parameters

Subwatershed	Stream Type	Start Date	End Date	Total Number of Records					
				Chemical Parameters				Biological Parameters	
				TDS (mg/L)	pH (s.u.)	DO (mg/L)	Temp. (°C)	<i>E. coli</i> (MPN/tray)	Macro-invertebrates
Lower City Creek	Perennial	Oct 2009	Feb 2014	29	26	23	29	73	5
Upper City Creek	Perennial	Oct 2009	Feb 2014	33	31	28	33	88	12
Lower Red Butte Creek	Perennial	Apr 2010	Feb 2014	29	24	25	29	60	5
Upper Red Butte Creek	Perennial	Oct 2009	Feb 2014	30	26	26	30	80	8
Lower Emigration Creek	Perennial	Oct 2009	Feb 2014	113	97	94	115	322	3
Upper Emigration Creek	Perennial	Oct 2009	Feb 2014	126	108	110	127	416	20
Lower Parleys Creek	Perennial	Oct 2009	Feb 2014	171	147	136	180	480	13
Upper Parleys Creek	Perennial	Oct 2009	Feb 2014	101	88	83	105	432	42
Lower Mill Creek	Perennial	Oct 2009	Feb 2014	77	67	60	77	162	7
Upper Mill Creek	Perennial	Sep 2009	Feb 2014	132	119	101	132	421	33
Lower Big Cottonwood Creek	Perennial	Sep 2009	Feb 2014	46	42	40	47	91	17
Upper Big Cottonwood Creek	Perennial	Sep 2009	Feb 2014	84	73	75	87	214	42
Lower Little Cottonwood Creek	Perennial	Nov 2009	Feb 2014	63	56	52	65	103	12
Upper Little Cottonwood Creek	Perennial	Sep 2009	Feb 2014	104	88	91	108	231	28
Dry Creek	Intermittent/ Ephemeral	Nov 2009	Nov 2009	0	0	0	0	0	1
Upper Willow Creek	Intermittent	Nov 2009	Jul 2013	1	1	1	1	0	5
Corner Canyon Creek	Intermittent/ Ephemeral	Nov 2011	Jul 2013	1	1	1	1	0	2
Lower Rose Creek	Intermittent/ Ephemeral	Mar 2011	Aug 2013	14	14	14	14	36	0
Upper Rose Creek	Intermittent/ Ephemeral	Jul 2013	Jul 2013	1	1	1	1	0	0
Lower Midas/ Butterfield Creek	Intermittent/ Ephemeral	Nov 2009	Feb 2014	29	27	25	29	71	1
Upper Midas/ Butterfield Creek	Intermittent/ Ephemeral	Nov 2009	Jul 2013	1	1	1	1	0	4
Lower Bingham Creek	Intermittent/ Ephemeral	Jan 2011	Feb 2014	29	27	25	29	72	0

Salt Lake County's Sampling Program

To gain a better understanding of the water quality data and trends, Salt Lake County's Watershed Planning & Restoration Program expanded its sampling efforts to include the collection and analysis of chemical, biological, and physical parameters in the creeks and streams in 22 sub-watersheds. This does not, for this report, include the Jordan River because UDWQ already collects water quality data at nine monitoring sites on the river (see Figure 3-16 and Table 3-10 above).

Chemical data collected include temperature, pH, DO, conductivity, TDS, salinity, atmospheric pressure, and turbidity. Consistent with the Sampling and Analysis Plan (SLCO 2013), the data is collected at legacy monitoring locations within each sampled sub-watershed using a multiparameter water quality meter. Biological data include *E. coli* bacteria and macroinvertebrate samples, which are collected and analyzed at the county offices and at the Utah State University Buglab, respectively. Chemical and biological data are collected at locations that represent the physical stream properties (water depth, stream width, and so on).

Summary of Sampling Results

For this 2015 Plan, the County selected six specific water quality data parameters for analysis: four chemical parameters—TDS, pH, DO, and temperature—and two biological parameters—most probable number (MPN) counts of *E. coli* bacteria, and the Simpson's Diversity Index for macroinvertebrates. The rationales for including these specific parameters in the plan update are discussed in the following sections. The monthly data (TDS, pH, DO, Temperature and *E. coli* MPN) data were averaged by monitoring location and by month, and the results are graphically presented in this section by sub-watershed.

The data presented are for informative and internal SLCo planning purposes and do not constitute an analysis for the purpose of determining whether county waterbodies meet state water quality standards or regulatory requirements. The analysis is intended as a summary of conditions from 2009 through 2014. Included in the sampling period were extremely wet (2010, 2011) and extremely dry years (2012, 2013), which help explain some possible irregularities in the data. This is because much of the data is collected on the basis of "wetted width," the width of the visibly saturated stream substrate, which is affected by the quantity of water present. Dry years tend to have lower flow rates in the streams and narrower wetted widths while wet years tend to be the opposite.

Table 3-10 above summarizes the sub-watersheds and number of records for the selected parameters. In some sub-watershed creeks, the County collected only a single sample of each parameter over the 5-year period (upper Willow Creek, Corner Canyon Creek, upper Rose Creek, and upper Midas/Butterfield Creek). These data clearly cannot be used to identify patterns or specific areas of concern. For other sub-watersheds (for example, the Emigration Canyon and Parley's Creek sub-watersheds), the County collected dozens of samples that can indicate short-term trends but might still not be representative of long-term conditions given the short sample period and the variety of wet and dry years sampled.

Although Salt Lake County attempted to regulate both sampling frequency and sampling density per sub-watershed—based on water quantity density to accurately establish the best estimate of overall watershed health—there were limiting factors outside of the County’s control that intervened in the number of samples collected. Stream hard freeze, streams drying up in summer months, irrigation withdrawal, excess snow accumulation, instrument failure, and construction activities all inhibited the collection of sample collection at one or more of the sampling locations during the sampling period. Furthermore, other annual phenomena control when sampling can occur. For example, some west side streams flow only during irrigation season from April to October. Considering these barriers, to the County collected as many samples as practicable.

The following sections summarize the 5-year results for the four chemical and two biological parameters.

Total Dissolved Solids

Total dissolved solids readings were recorded as part of Salt Lake County’s expanded water quality data collection program. TDS was selected for analysis in this 2015 Plan because it indicates the presence of minerals dissolved in water. The minerals that make up the measurement of TDS are calcium, sulfate, magnesium, sodium, potassium, and chloride; these minerals are generally referred to as salts. High TDS concentrations can affect the amount of available oxygen in the water for aquatic species and can reduce water clarity. Some sources of TDS are natural geological formations, stormwater runoff, agricultural runoff, and wastewater and septic system discharges.

The monthly average TDS for monitoring locations within 22 sub-watersheds was analyzed for 2010 to 2014 (see Table 3-11) The reference value that the County uses for TDS is different for each sub-watershed, based on the background (naturally occurring) geochemical values at the stream headwaters. It is not intended to be a regulatory standard, but as an average point to observe variance. For streams that have an agricultural beneficial use and that are not covered by a site-specific standard, the state standard is 1,200 milligrams per liter (mg/L). Figure 3-17 through Figure 3-21 depict the average monthly TDS in each sub-watershed from 2010 through 2014.

What is a reference value?

A reference value represents a good or ideal condition of a water quality parameter. A quantitative analysis can be performed whether the measured parameter is above or below the reference value.

The following summary can be made regarding the TDS data results:

- The reference value of 300 mg/L was exceeded in lower Little and Big Cottonwood Creeks most of the year. The reference value was exceeded in upper Little Cottonwood Creek in April and August.
 - There are canals entering the Big and Little Cottonwood streams near the Highland Drive area that dramatically alter the flow and chemistry of the receiving waters.
- The reference value of 400 mg/L was exceeded in lower Mill Creek in all months except April and May. In upper Mill Creek, the standard was exceeded in January, February, March, July, August, and November.
 - Due to water quality sonde malfunction, data was not observed during the month of September for many sites.
- The reference value of 600 mg/L was exceeded in lower Parley’s Creek and in lower Emigration Creek for most of the year, on average.
 - Lower Red Butte Creek is often dry at the Miller Park sampling location and is also prone to flash flooding. TDS values can be very unpredictable as a result of the highly irregular flows at that site.
- The agricultural beneficial-use standard of 1,200 mg/L was exceeded in lower Rose Creek in March. This standard was exceeded in lower Midas/Butterfield Creek for most of the year.
 - Most of the water in these creeks originates from canal overflow and tends to be very high in TDS.
- The reference value of 2,500 mg/L was exceeded in upper Parley’s Creek in September.
 - Upper Parley’s Creek has an unusually high TDS average likely due to the nature of the source rock of the springs that feed the stream.

Figure 3-17. Average Monthly TDS for Little and Big Cottonwood Creeks (2010 - 2014)

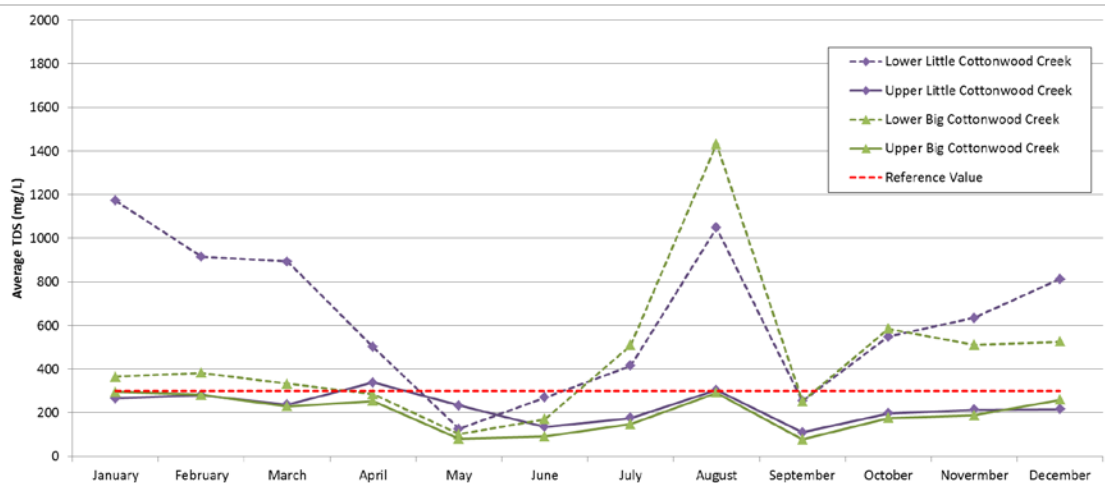

Figure 3-18. Average Monthly TDS for Mill Creek (2010 - 2014)

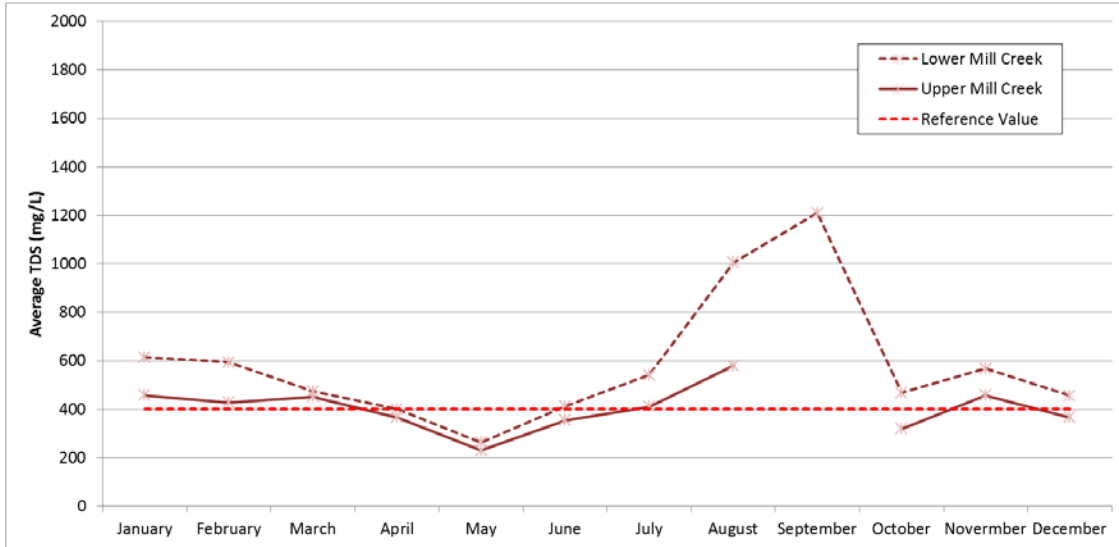

Figure 3-19. Average Monthly TDS for City, Red Butte, Emigration and Lower Parley's Creeks (2010 - 2014)

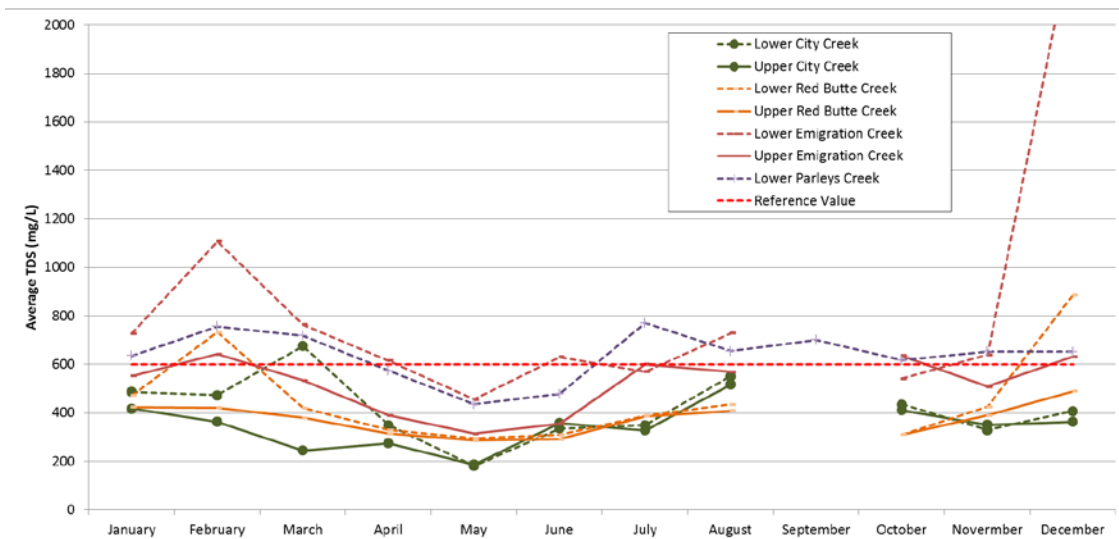

Figure 3-20. Average Monthly TDS for Upper Parley's Creek (2010 - 2014)

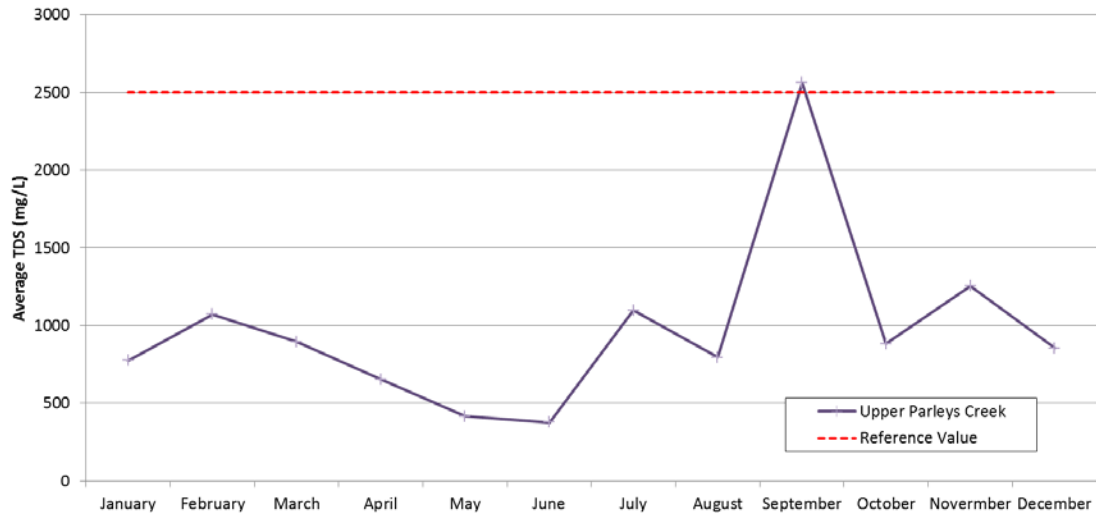
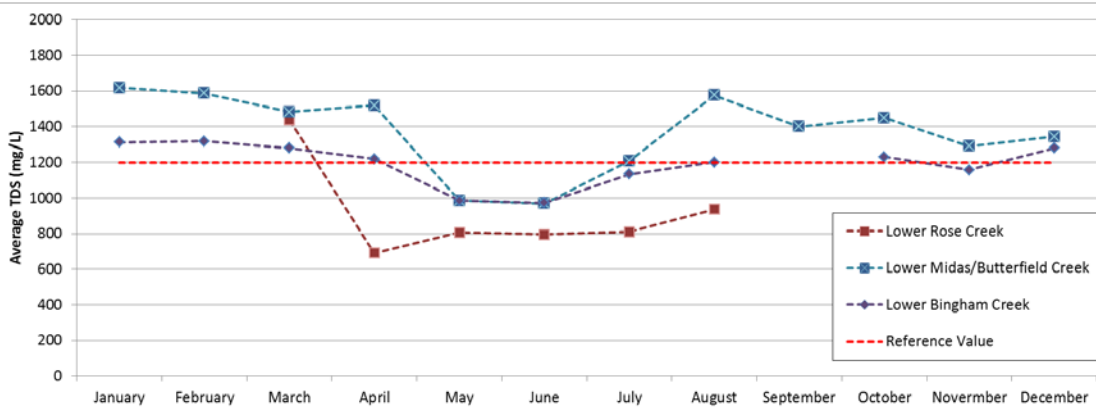

Figure 3-21. Average Monthly TDS for Bingham, Rose, and Midas/Butterfield Creeks (2010 - 2014)



pH

pH readings were recorded as part of Salt Lake County's expanded water quality data collection program. Instream values of pH were analyzed for the annual average within 22 sub-watersheds (see Table 3-11).

The pH of surface water can affect the rate of chemical solubility and toxicity of the water and the diversity of biological organisms. The standard range set by the State of Utah is 6.5 standard units (s.u.) to 9 s.u. for waters in the county. Lower or higher pH readings can indicate that conditions are present to mobilize toxic constituents, an action that can harm aquatic species. Arid climates commonly have pH ranges above neutral averaging in the range of 8-8.5. Arid climates with variable source rock geochemistry including limestone can also have high alkalinity as well, which tends to resist changes to the pH level. If pH levels are observed to drop in certain locations it can be an indicator of significant water chemistry change. Known sources that can drive the pH of streams up or down are mine drainage, concrete spills or illicit dumping and industrial discharge.

Figure 3-22 through Figure 3-24 depict the average pH for each sub-watershed from 2010 to 2014.

The following summary can be made regarding the pH data results:

- The annual average pH for lower sub-watershed creeks appears to be lower than for the upper sub-watershed creeks. This trend is apparent in other sub-watersheds except Red Butte and Big Cottonwood Creeks.
- Lower and upper Little Cottonwood Creek have the lowest pH of all monitored watersheds.
 - This is likely due to the historic mining legacy in these canyons and the low pH drainage that still flows from the mine drains.

Figure 3-22. Average pH for Streams in the Northeastern County Area (2010 - 2014)

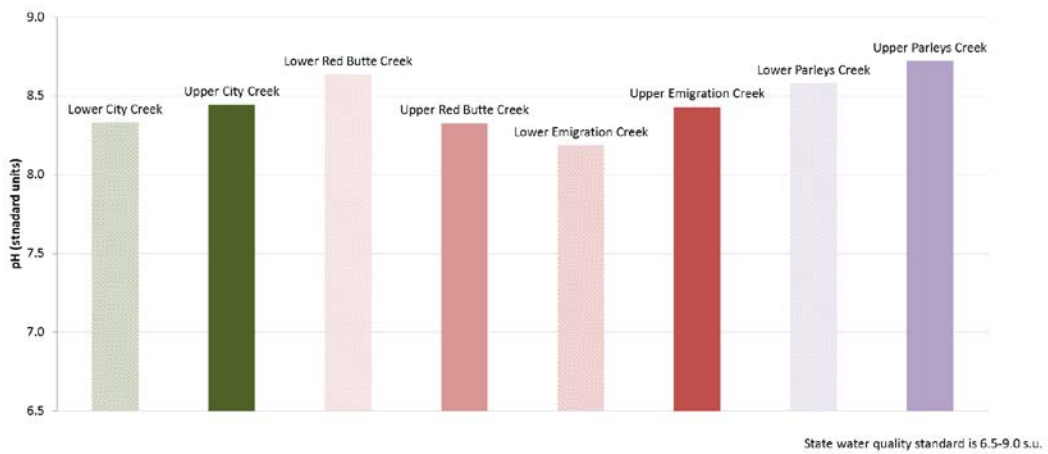

Figure 3-23. Average pH for Streams in the Southeastern County Area (2010 - 2014)

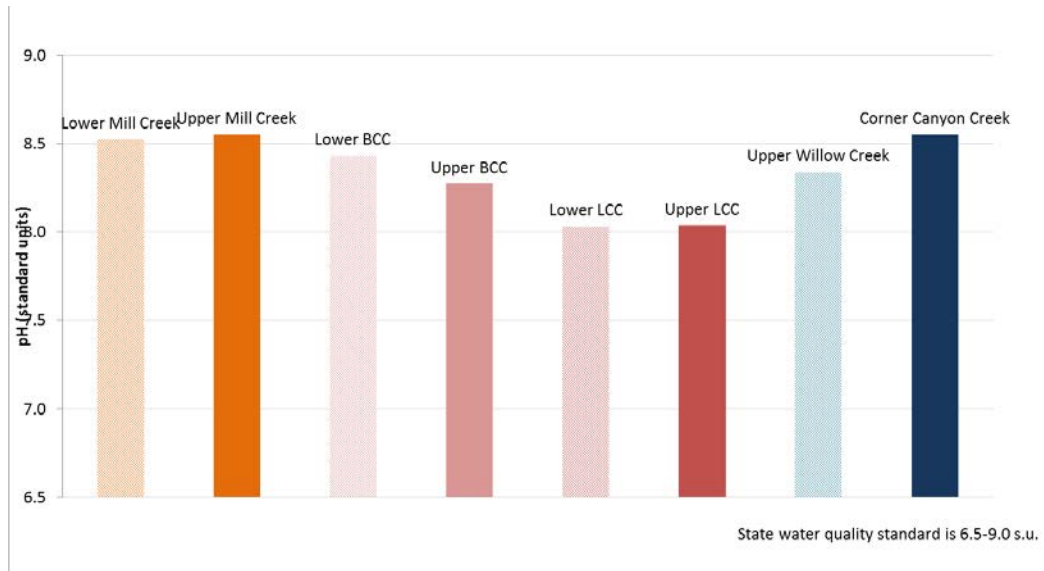
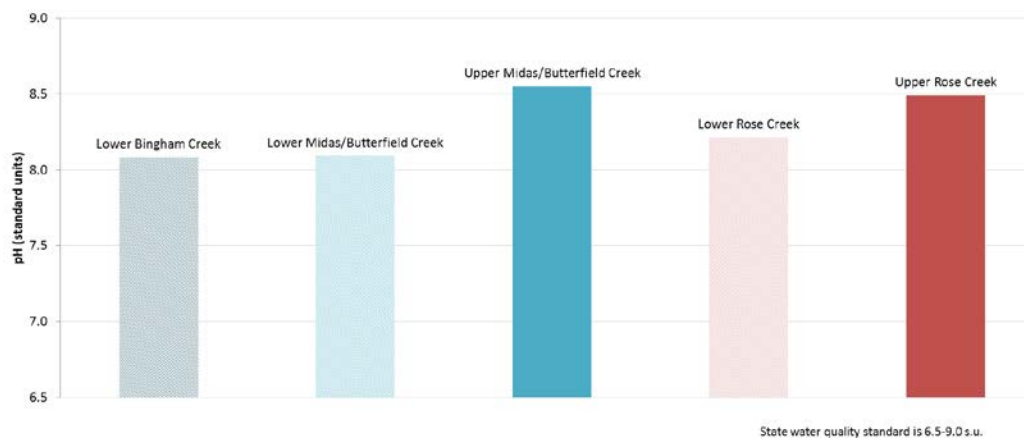

Figure 3-24. Average pH for Streams in the Southwestern County Area (2010 - 2014)



Dissolved Oxygen

Dissolved oxygen (DO) readings were recorded as part of Salt Lake County's expanded water quality data collection program. DO is an indicator of the amount of oxygen available in the streams to support macroinvertebrates and fish populations. Low DO conditions can harm aquatic habitat by limiting the amount of oxygen available for aquatic organisms. Low DO conditions can be caused by excessive algae growth (because algae consumes the oxygen in the water), high levels of nutrients (most notably phosphorus and nitrogen), high oxygen demand (such as by biological or chemical processes or sediment characteristics), or the decay of submerged plants.

The monthly average DO readings from 2010 to 2014 were analyzed for 22 sub-watershed creeks (see Table 3-11). The reference value of 4.5 mg/L was used by the County for comparative purposes for all sub-watersheds. The state water quality standard for minimum DO for various aquatic wildlife beneficial uses is established by UAC R317-2 and ranges between 4.0 and 9.5. Figure 3-25 through Figure 3-27 depict the average monthly DO from 2010 to 2014.

The following summary can be made regarding the DO data results:

- Average DO exceeded the reference value most of the time in all of the sub-watersheds throughout the 5-year survey period, indicating that the sub-watersheds have sufficient DO levels to support aquatic habitat.
 - The only notable exception of the trend is Upper Parley's Creek. The data is a limited point taken on a cool September day which had unusually high DO.
 - The data gap persists with sonde malfunction in September.
- All sub-watershed creeks show a dip in DO readings in July and August. This is expected because stream flows are seasonally low, and temperatures are generally higher, during these months.
- The DO readings for upper and lower perennial sub-watershed creeks show similar monthly variations for most of the data with the some exceptions.

Figure 3-25. Average DO for Streams in Northeastern Salt Lake County (2010 - 2014)

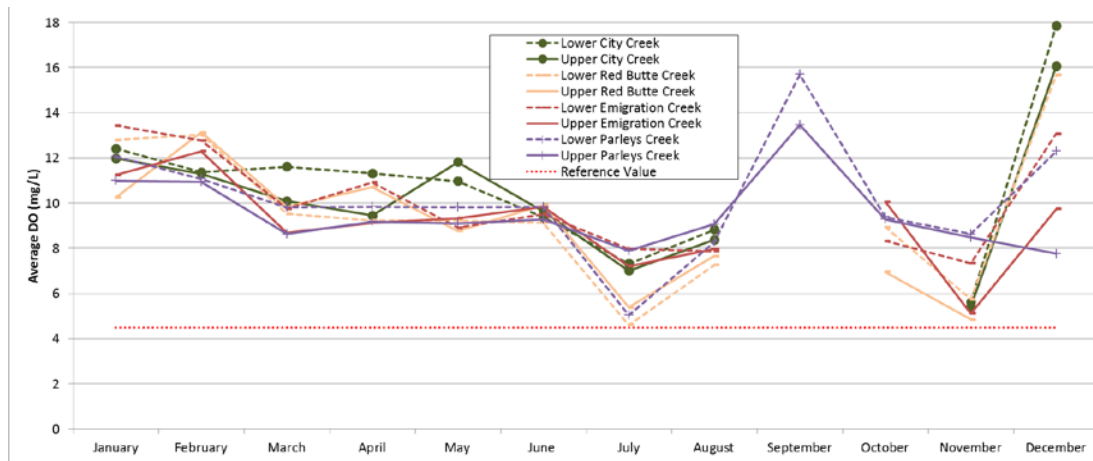

Figure 3-26. Average DO for Streams in Southeastern Salt Lake County (2010 - 2014)

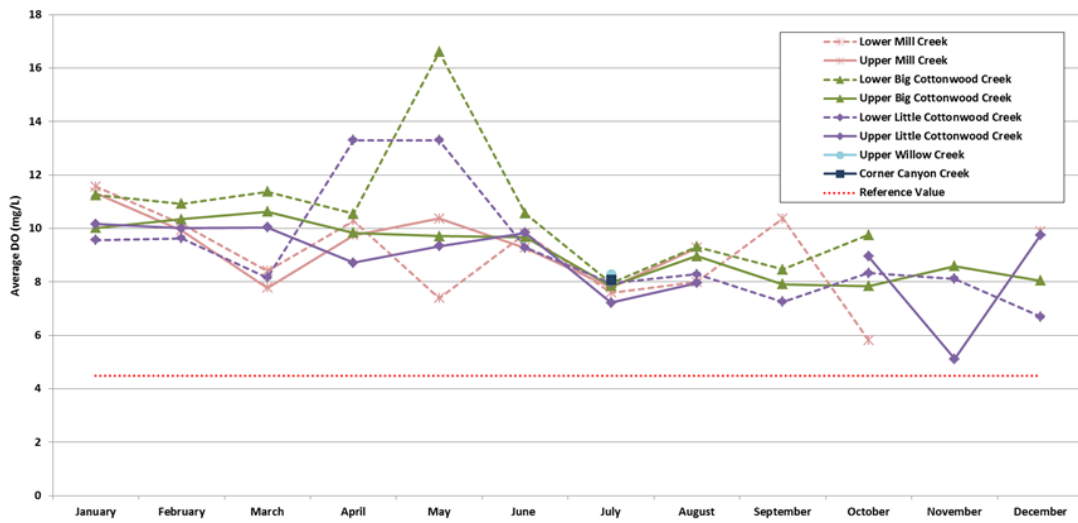
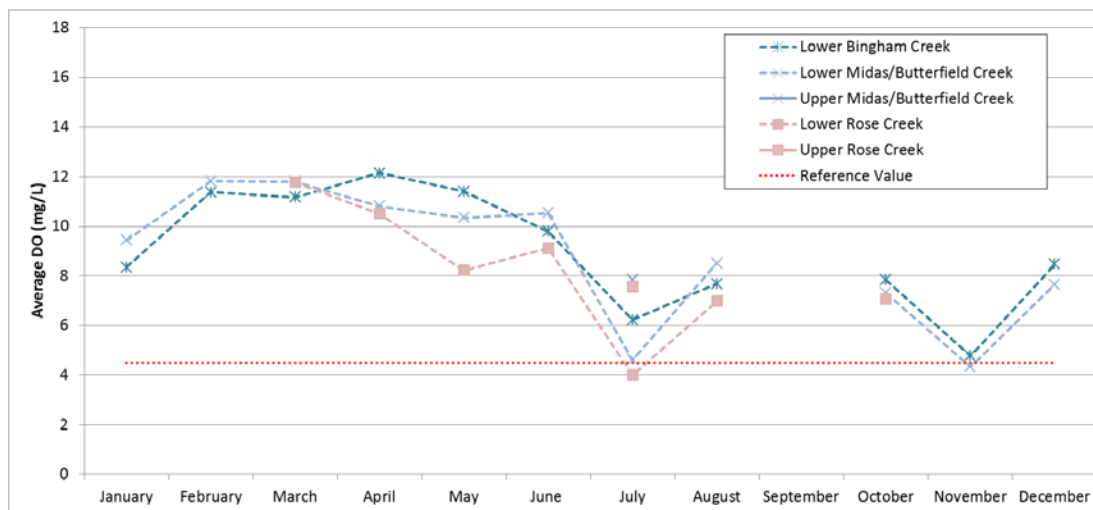

Figure 3-27. Average DO for Streams in Southwestern Salt Lake County (2010 - 2014)



Water Temperature

Water temperature readings were recorded as part of Salt Lake County's expanded water quality data collection program. Water temperature is an important measure because temperature can affect biological activity and species diversity and populations as well as water chemistry processes. Water temperature often dictates healthy conditions for cold-water and warm-water fish, and water temperatures affect aquatic diversity, metabolism, growth, and reproduction. The rate of chemical solubility and reactions generally increase with higher temperatures.

The average monthly water temperature data from 2010 to 2014 were analyzed for 22 sub-watersheds (see Table 3-11). Water temperature varied seasonally across all sub-watershed creeks sampled. A reference value of 20 degrees Celsius (°C) was used by Salt Lake County, and was met for most sub-watershed creeks for most of the year. The state water quality temperature standard is set at 20°C for cold-water aquatic wildlife, with the water quality temperature standard at 27°C for warm-water and other aquatic wildlife. Figure 3-28 through Figure 3-30 show the average monthly temperatures for each sub-watershed from 2010 to 2014.

The following summary can be made regarding the temperature data results:

- Water temperature was below the reference value most of the time during the 5-year survey period for all creeks sampled.
- Lower sub-watershed creeks were significantly warmer on average than were the upper sub-watershed creeks for the same monitoring event.
- The average water temperature in lower Little Cottonwood Creek and lower Big Cottonwood Creek slightly exceeded the reference value in August. This could be a result of the low flows that generally are observed during the later summer months.
- The average water temperatures in lower Mill Creek and lower Big Cottonwood Creek slightly exceeded the reference value in September.
- The average water temperature in lower Rose Creek and lower Bingham Creek exceeded the reference value in July and August.
- Apparent “floating” data points indicate discreet sampling associated with an annual sample, not part of a monthly sampling routine. They are more of snapshot of conditions than trend indicators.

Figure 3-28. Average Monthly Temperature for Streams in the Northeastern County Area (2010 - 2014)

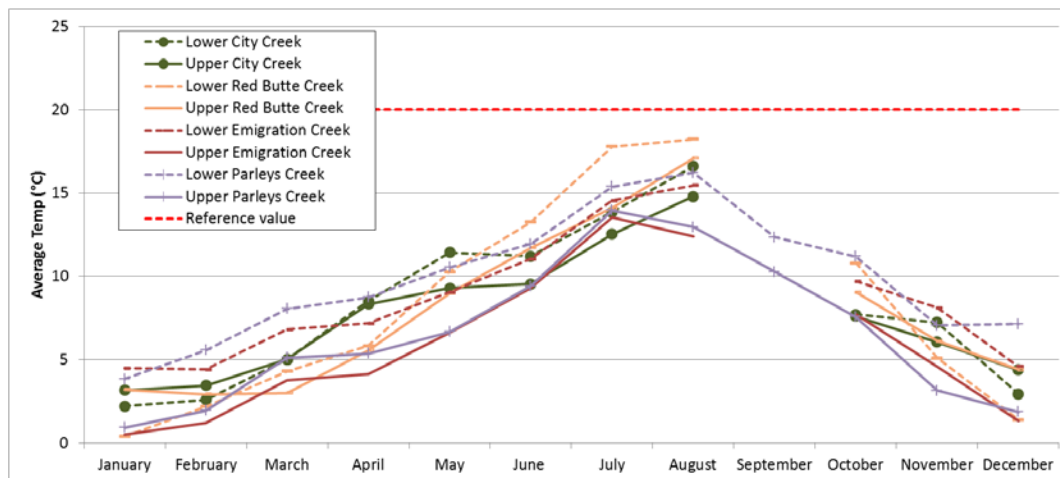

Figure 3-29. Average Monthly Temperature for Streams in the Southeastern County Area (2010 - 2014)

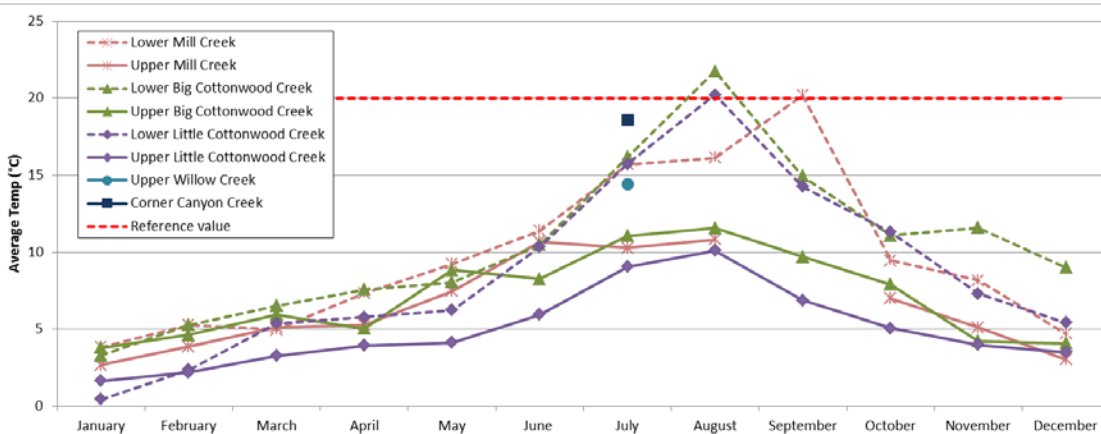
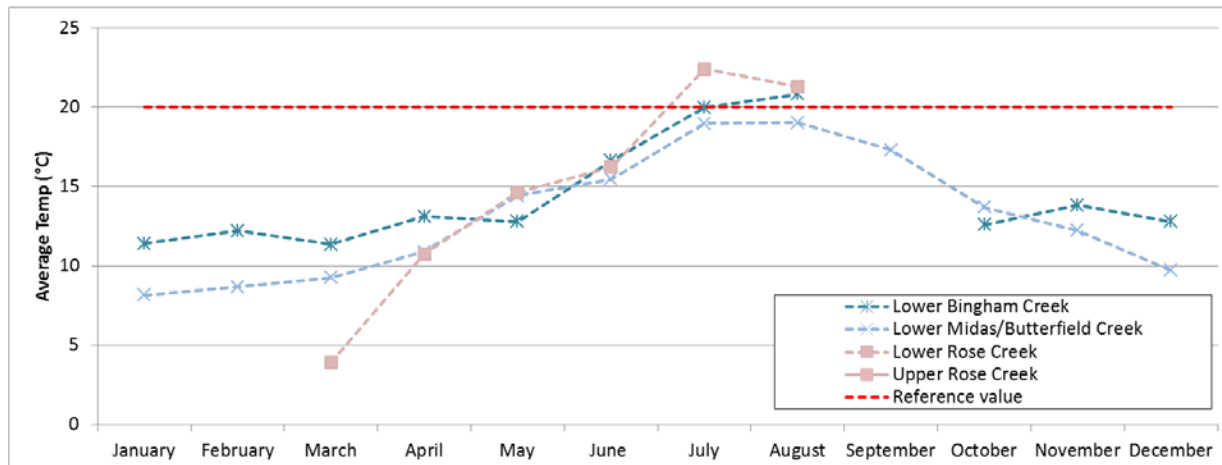

Figure 3-30. Average Monthly Temperature for Streams in the Southwestern County Area (2010 - 2014)



***Escherichia coli* (*E. coli*) Bacteria**

Escherichia coli (*E. coli*) bacteria samples were collected and analyzed as part of Salt Lake County's expanded water quality data collection efforts. *E. coli* is a type of bacteria commonly found in the intestines and feces of healthy warm-blooded animals and humans. The measurement of *E. coli* in a waterbody is an indication of the presence of human and/or animal waste contamination and possible harmful bacteria in surface waters.

Although there are multiple methods for determining the amount of *E. coli*, the County conducted the *E. coli* data analysis using the average MPN per sample tray method consistent with state water quality standard methodology. The County uses the UDWQ secondary contact recreation beneficial-use standard of 206 MPN/tray as a comparative number. However, UDWQ has set a lower standard of 126 MPN/tray for primary contact recreation (UAC R317-2-14). The average MPN/tray per month was analyzed for each sub-watershed. Figure 3-31 through Figure 3-33 depict the results of the analysis.

Since the 2009 Plan was implemented, high levels of *E. coli* have been documented by UDWQ in the county. This finding has led to many streams in the county being listed on the latest draft 2014 303(d) list as not meeting water quality standards for recreational uses that involve physical contact with the water (see Table 3-5). The following stream segments are on the 2014 draft 303(d) list due to not meeting *E. coli* standards: upper and lower Emigration Creek, lower Parley's Creek, lower and upper Mill Creek, lower Big and Little Cottonwood Creeks, and Butterfield and Rose Creeks.

Figure 3-34, Figure 3-35, and Figure 3-36, provide a finer scale analysis of the data collected on Emigration, Parleys and Mill Creeks. Average *E. coli* data are shown for various monitoring locations along each stream, to examine differences between upper and lower sub-watersheds. The lowest (farthest-downstream) monitoring point on the stream is shown at the left of the graph, and the uppermost monitoring point on the stream is shown at the right.

The following summary can be made regarding the *E. coli* data results:

- Levels of *E. coli* higher than the state standard (206 MPN/tray) were observed during the summer months of July, August, and September for all lower sub-watersheds except lower Red Butte Creek. The highest average levels were observed in lower Red Butte Creek in February (1,402 MPN/tray) and in lower Little Cottonwood Creek (830 MPN/tray), lower Bingham Creek (1,130 MPN/tray), and lower Midas/Butterfield Creek (1,584 MPN/tray) in July.
- The presence of *E. coli* increased downstream for Emigration, Parley's, and Mill Creeks, particularly during the summer months.
- There was no significant difference in the average *E. coli* level among most of the lower sub-watersheds sampled, whereas there was a significant difference in the average *E. coli* level among most upper sub-watersheds.
- Dramatic *E. coli* increase is noted below the canal inflows to Little and Big Cottonwood Creeks near Highland Drive during irrigation months.
- Irrigation season is marked by high *E. coli* MPN on all west side streams.
 - Rose Creek has no water outside irrigation season.

Figure 3-31. Average Monthly *E. coli* for Streams in the Northeastern County Area (2010 - 2014)

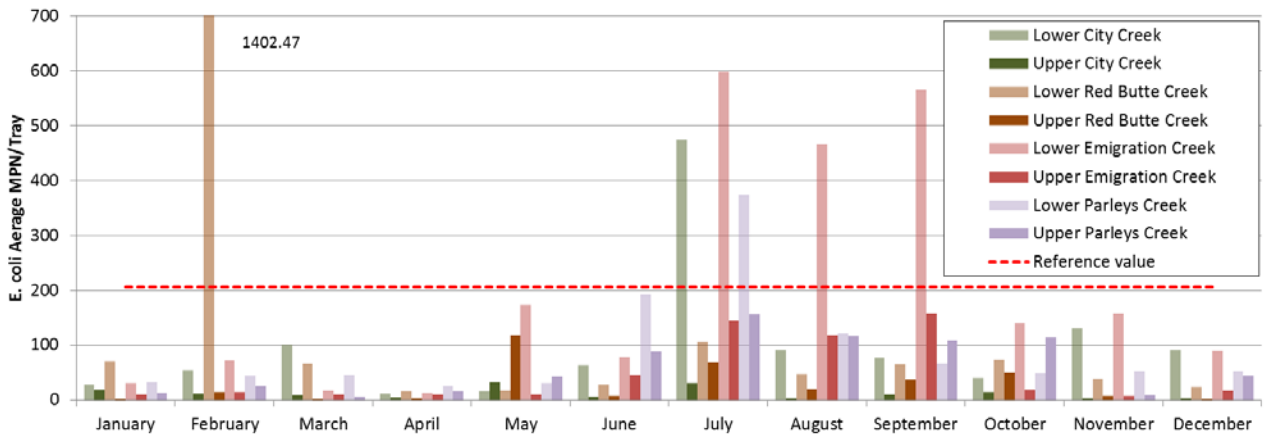

Figure 3-32. Average Monthly *E. coli* for Streams in the Southeastern County Area (2010 - 2014)

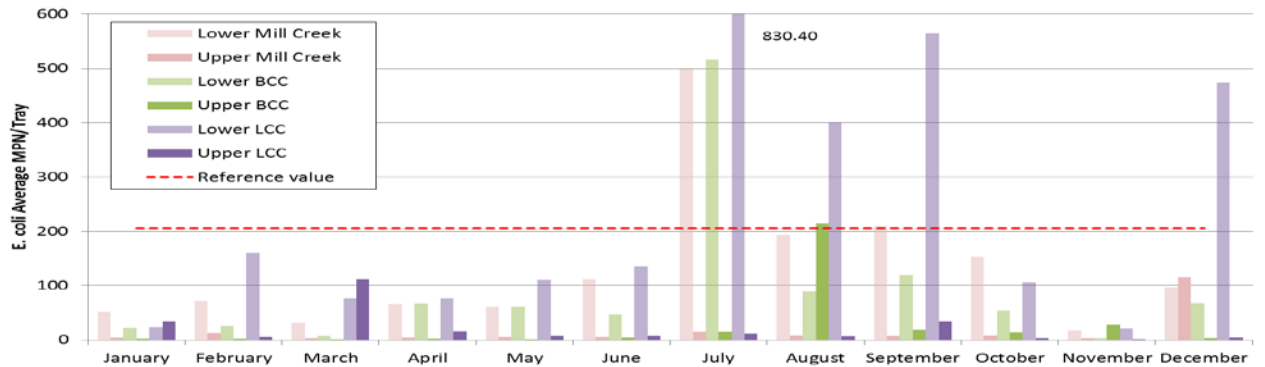

Figure 3-33. Average Monthly *E. coli* for Streams in the Southwestern County Area (2010 - 2014)

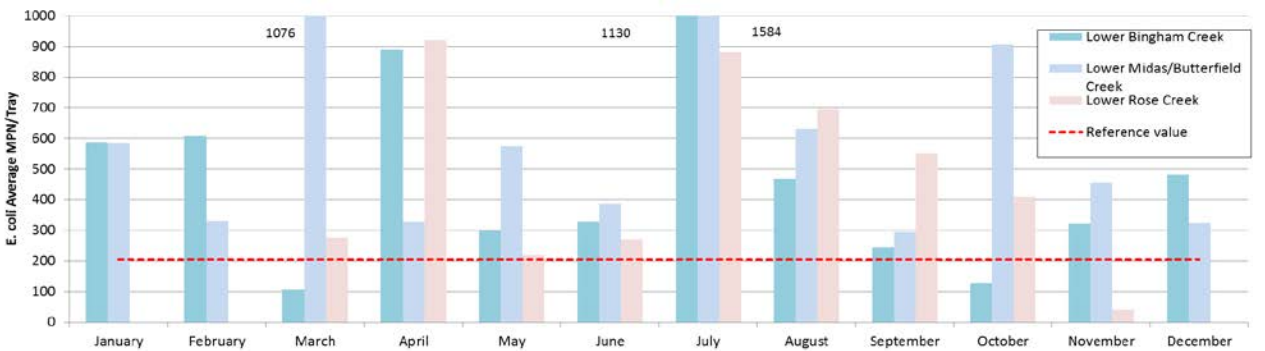

Figure 3-34. Average *E. coli* Data for Various Monitoring Locations along Emigration Creek (2010 - 2014)

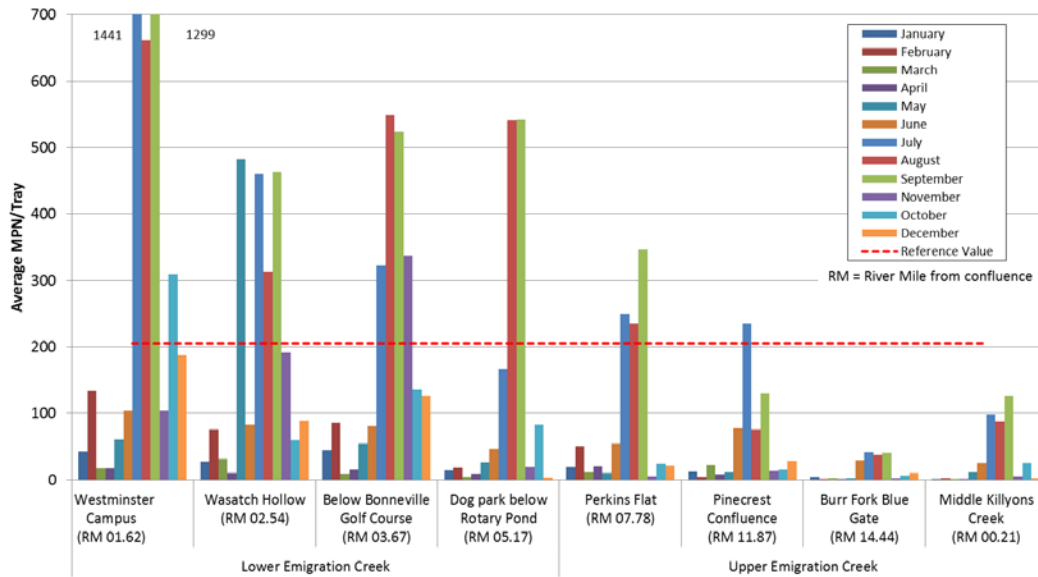

Figure 3-35. Average *E. coli* Data for Various Monitoring Locations along Parley's Creek (2010 - 2014)

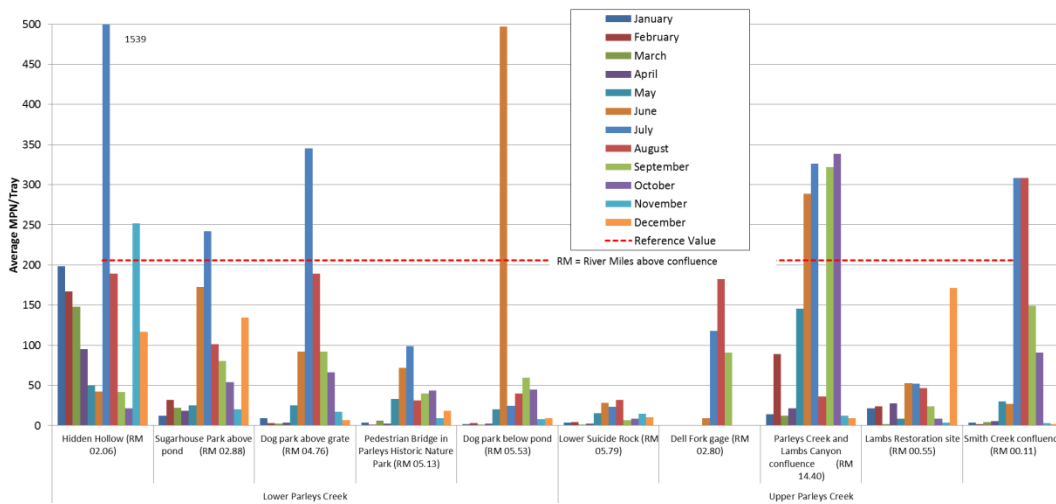
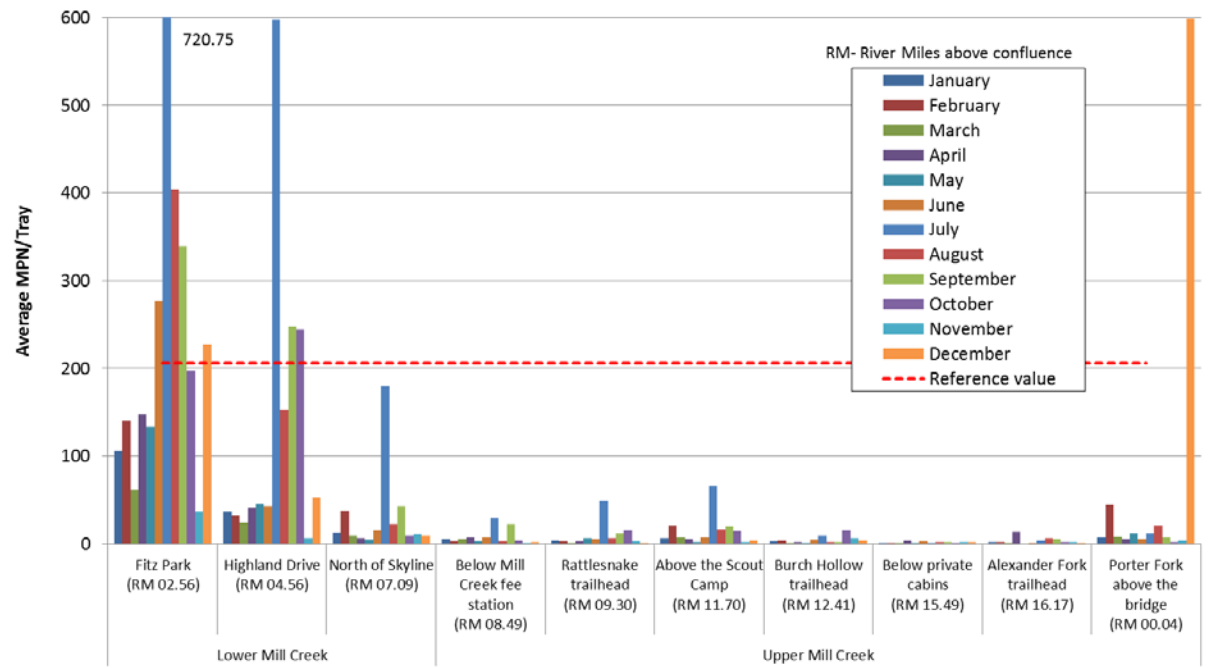

Figure 3-36. Average *E. coli* Data for Various Monitoring Locations along Mill Creek (2010 - 2014)



Macroinvertebrates

Benthic macroinvertebrate samples were collected and analyzed as part of Salt Lake County’s expanded water quality data collection efforts. Benthic macroinvertebrates are small aquatic organisms (a.k.a. bugs) that can be seen with the naked eye. They do not have backbones, and they live in streams on and around rocks and sediments.

Macroinvertebrate populations and species diversity are good indicators of water quality because they rely not only on the chemistry of the water but also on the health of the overall ecosystem, including substrate type, shade cover, and riparian health. Macroinvertebrates can be collected in high numbers, have known pollution tolerances, have limited mobility, have a wide range of feeding habits, have varied life spans, and depend on the land environments around a stream (Oleson 2013). Every moment respiration occurs in a bug is akin to taking a water sample, and, unlike fish and other more mobile animals, aquatic bugs cannot move away from polluted waters. Most have an annual life cycle, but some larger species can spend up to five years as larvae living under water. By taking one sample of a macroinvertebrate community, scientists are potentially compiling at least a year’s worth of water quality data.

Different analyses can be conducted using the macroinvertebrate counts collected at a sample site. The County used the Simpson’s Diversity Index, which is a comparison of the abundance of individuals of each species to the total number of organisms collected, represented as a percentage. Higher percentages indicate more diversity within the system, and a lower percentage indicates less diversity. The index can also be an indirect indicator of degradation in the stream environment. Simpson’s Diversity Index does not, however, factor in differing species individual tolerance of stressors including low DO levels or abundance of metals, etc. Thus a perpetually

lower water quality site can have the same apparent score as a site of relatively higher quality. The scoring of each site annually is much more relevant than the score of each site in comparison to one another.

Figure 3-37 through Figure 3-39 depict the average Simpson's Diversity Index for 2009, 2011, 2012, and 2013.

The following summary can be made regarding the macroinvertebrate data results:

- 2010 data collection was limited in scope and availability thus the year was discarded to eliminate a skew in the index for certain sites.
- 2009 was the end of a decade-long drought cycle that produced little runoff to scour out silt deposits. This excess silt deposition, which is known to negatively impact riverine macroinvertebrate habitat, likely played a significant role in displacing macroinvertebrate populations.
- 2011-13 displayed significantly different diversity and is likely the result of a changing hydrologic cycle. 2011, in particular shows dramatic increase in macroinvertebrate populations and is also the wettest record year for most of the watersheds involved in this study. The following years are likely benefiting from the high flows moving sediment through the system and "reinvigorating" previously degraded habitat.
 - Ancillary field investigations (Phankuch Level 3 Assessments) report higher channel bottom particle consolidation, distribution and scour/deposition scores which quantitatively support seasonal high flow redistribution of sediment and habitat potential for macroinvertebrate communities.
- In general, higher diversity indices were observed in the upper sub-watersheds.
- The average Simpson's Diversity Index was significantly different for all 4 years of sampling in lower City Creek, lower Emigration Creek, and upper Midas/Butterfield Creek.

Figure 3-37. Average Simpson's Diversity Index for Streams in the Northeastern County Area (2009, 2011, 2012, and 2013)

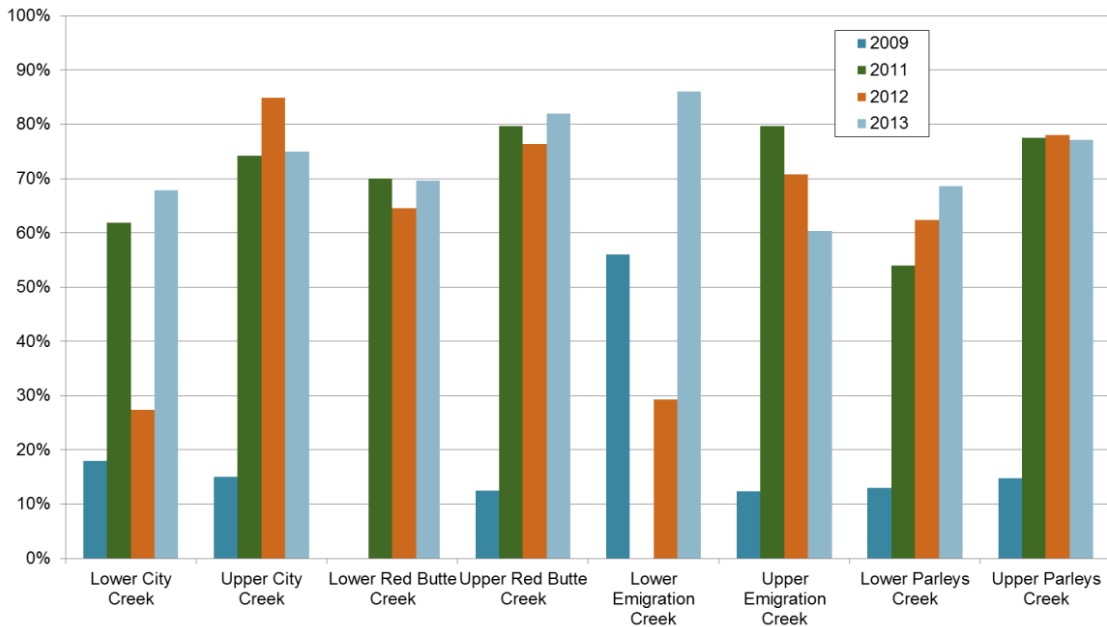

Figure 3-38. Average Simpson's Diversity Index for Streams in the Southeastern County Area (2009, 2011, 2012, and 2013)

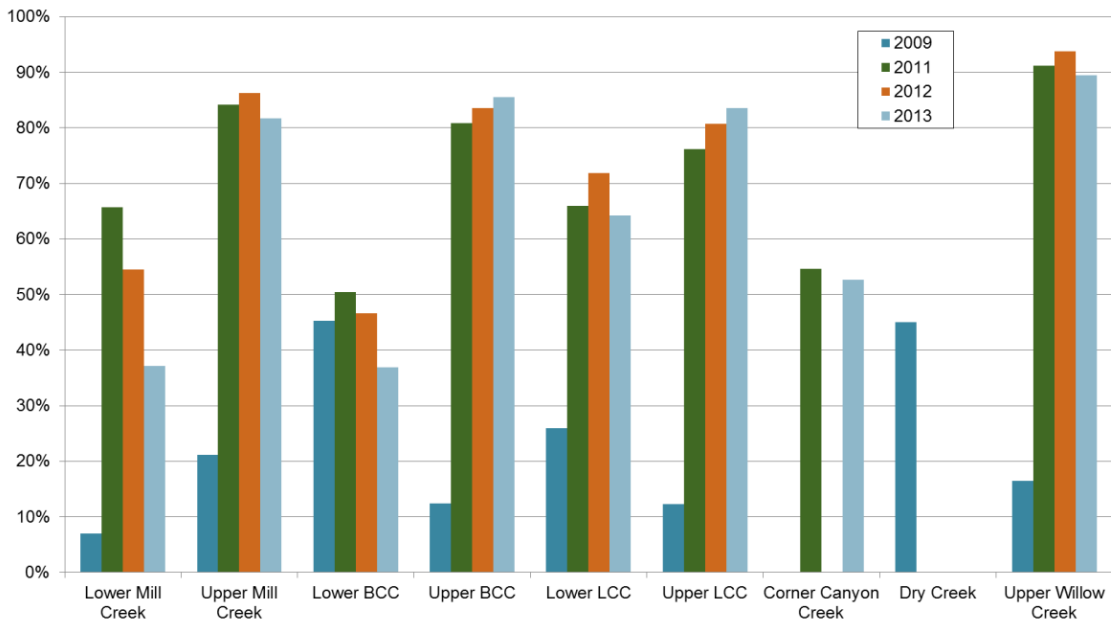
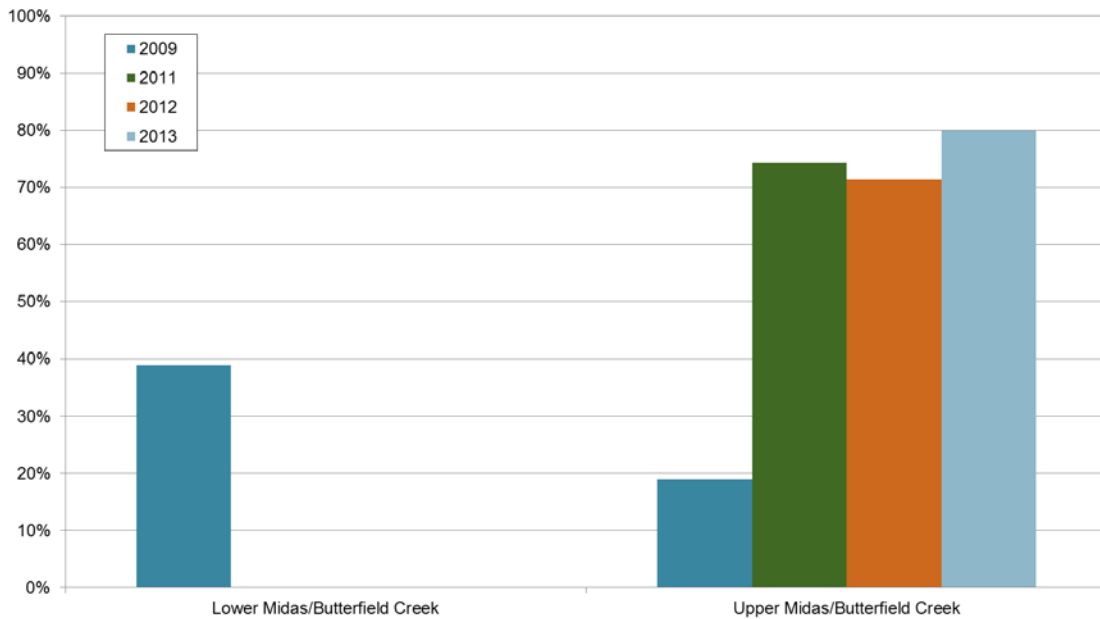

Figure 3-39. Average Simpson’s Diversity Index for Streams in the Southwestern County Area (2009, 2011, 2012, and 2013)



Jordan River Sampling by UDWQ

UDWQ routinely collects water quality data throughout the state to support regulatory programs including the State’s Water Quality Assessment and TMDL Program. Water quality data collected from the Jordan River and other waterbodies in the county are stored in a database.

Currently, UDWQ collect two types of data on the Jordan River that help support the State’s water quality programs, including implementation of the TMDL: 1) ambient data (episodic, single-sample collection); and 2) high-frequency data (continuous data collection at 15-minute intervals). The water quality parameter of concern for the lower Jordan River Phase 1 TMDL is DO with the pollutant of concern being organic matter, but UDWQ collects much more information including metals, inorganic parameters, radiological parameters, organic parameters, physical characteristics of water, and biological characteristics.

The County searched UDWQ’s water quality database to identify the Jordan River monitoring locations and data results from January 1990 through October 2015. Figure 3-16 shows the Jordan River monitoring locations. All of the ambient monitoring included data collection for pH, DO, and temperature, which are physical characteristics of water. Table 3-11 summarizes the general water quality data categories collected at each monitoring location.

The State’s database of water quality parameters can be used to conduct analyses to support water quality management programs and projects for the Jordan River and other waterbodies in the county. The County did not conduct any specific water quality parameter analysis on the State-collected data for the Jordan River, since the State’s Jordan River TMDL study provides this information.

Table 3-11. Jordan River Water Quality Monitoring Locations

Sampling Type ^a	Name of Monitoring Location	Period of Record ^b	Parameters Sampled					
			Metals	Inorganics	Radiological	Organics	Char of Water	Biological
A, HF	State Canal at road crossing (about 400 South)	January 1990–September 2012	✓	✓		✓	✓	✓
A, HF	Above Burnham Dam and State Canal	August 2006–July 2014	✓	✓		✓	✓	
A, HF	Cudahy Lane above South Davis S Wastewater Treatment Plant (WWTP)	January 1990–July 2014	✓	✓		✓	✓	✓
A	2600 North	May 2000–September 2012	✓	✓		✓	✓	
A	1800 North crossing/Redwood Road Bridge	January 1990–September 2012	✓	✓	✓	✓	✓	✓
A	1000 North crossing	August 2001–March 2012					✓	
A	500 North crossing	August 2006–September 2012	✓	✓		✓	✓	
A, HF	300 North	October 2009–July 2014		✓			✓	
A	Below Gadsby Plant 001 outfall at North Temple	January 1990–June 2005	✓	✓			✓	
A	400 South	June 2004–September 2010		✓			✓	
A	300 South							
A	700 South	June 2004–September 2004		✓			✓	
A, HF	800 South above drain outfall	July 2014					✓	
A	900 South	January 1990–July 2014	✓	✓			✓	
A	1300 South storm sewer mouth	August 2006–September 2014	✓	✓		✓	✓	
A	California Ave. (1300 South) crossing	June 2004–August 2004		✓			✓	
A, HF	1100 West 2100 South	January 1990–September 2014	✓	✓		✓	✓	
A, HF	3300 South crossing	January 1990–September 2014	✓	✓		✓	✓	
A	3900/4100 South crossing	January 1990–September 2012	✓	✓	✓	✓	✓	
A	Above 5400 South at pedestrian bridge	May 1990–September 2012	✓	✓		✓	✓	✓
A	7800 South crossing above South Valley WWTP	January 1990–July 2014	✓	✓		✓	✓	✓
A	9000 South crossing	January 1990–July 2014	✓	✓	✓	✓	✓	
A	10600 South	September 2006–July 2014		✓		✓	✓	
A	Below 12300 South	October 2003–December 2008		✓		✓	✓	✓
A	Bluffdale Road crossing	January 1990–July 2014	✓	✓	✓	✓	✓	✓
A	Narrows – pump station	January 1990–July 2014	✓	✓	✓	✓	✓	✓
A, HF	Utah Lake Outlet/State Route 121 crossing	January 1990–July 2014	✓	✓	✓	✓	✓	✓

Source: UDWQ 2015

^a A = ambient data collection; HF = high-frequency data collection

^b As of November 2014. Period of record for ambient monitoring is the entire timeframe within which samples were taken. Sampling intervals and numbers of samples taken vary by site. Period of record is provided to provide basic timeframe information only.

Summary

Reliable water quality data is a beneficial tool for decision making with respect to restoration activities, the impacts of development, construction and other landscape altering activities, as well as further understanding the impacts of water management activities like seasonal high flows and irrigation and drain inflows to streams. As the catchment for all of these ecological stressors watersheds and the data used to describe their health must be considered carefully. Beginning in 2009, the County has collected chemical and biological data in 22 sub-watershed creeks. These data indicate water quality and biological conditions that are a result of watershed activities and stream characteristics. The County data are analyzed to provide a general assessment of water quality, not to meet any regulatory program requirements.

General findings from the data analysis are:

- The need for reliable water quality data is increasing as managers rely on data to prioritize, design, and implement watershed policies and improvement projects to benefit economic and social development. The data collection process must be undertaken in the most scientifically valid and outcome oriented fashion. A spatial database delivering nearly real-time updates to data users would be a significant improvement over annual reporting. Technology can also assist with the expediency of the data collection and cost the County less in this process.
- Wherever possible, based on availability of instream water sufficient for sampling and year-round safe stream access, the County should increase the data collection efforts for streams where current sampling efforts are not as robust.
- Specific stream water quality and biological data must be reviewed in the context of the hydrologic regime of the stream. For instance, the macroinvertebrates present in a perennial stream system will not be the same as those found in an intermittent or ephemeral stream system. In addition, sampling for macroinvertebrates in the intermittent and ephemeral stream systems may not be possible.
- The Water Quality sampling regimen undertaken by the County was significantly increased for this plan update. There are, however, data gaps that can be identified in this dataset. Specifically, west side streams are underrepresented in the data due to lack of reliable water. Despite the lack of reliable water, the County will continue to search for suitable sampling locations along west side streams.
- Data from lower west side streams also generally represents canal overflow and not water hydrologically connected to groundwater or surface water runoff. Best efforts must be taken by the County to ensure west side streams are represented as responsibly as possible.
- Canal or drain inflow locations should be considered as above and below sampling locations as these inflows seem to delineate lower metric scores across all measured indices.

3.6 Habitat

2009 Plan and Stream Function Index

The 2009 Plan generally discussed aquatic and riparian habitat along stream corridors and wetlands and the locations where these resources are found within the county. In addition to the general discussion in the 2009 Plan, the County presented the results of an inventory and analysis of the general conditions of the physical, chemical, and biological elements of the county's waterways. This Stream Function Index (SFI) consolidated data collected in 2007 and 2008 using a rapid stream assessment methodology (SLCO 2010). The SFI was developed to allow the County to monitor four stream functions—habitat, hydraulics, water quality, and social/recreation—in order to identify areas where water quality conditions are good, and need to be protected, as well as where management policies and practices are needed to improve conditions. In all, for the 2009 Plan, the County evaluated 245 miles of streams and 44 miles of the Jordan River in terms of the four functional groups.

Specific to the habitat function, the SFI was used to identify habitat areas that need improvement and steps to improve stressed habitat areas and preserve healthy stream habitat sections.

The 2009 SFI reported an average habitat score of 74 for streams within the county (on this scale, 0 is a poor rating and 100 is an excellent rating). The average habitat score was calculated from an average of both stream channel and riparian corridor characteristics, which had scores of 67 and 80, respectively. The upper watersheds in the county generally scored higher than the lower watersheds with the exception of upper Emigration, Little Cottonwood, and Midas/Butterfield Creeks (SLCO 2010).

Physical Habitat Data Collection and Analysis

Starting in 2009 through 2014, the County collected physical habitat (phab) data along stream segments in the county in order to assess the existing conditions of these segments. When collecting these habitat data, the County generally followed the 2009 SFI methodology, although the qualitative protocols were amended to make them more quantitative.

The purpose of the phab data collection was to provide a scientific basis for the County to identify stream reaches for stream channel and riparian restoration or rehabilitation projects. This section

What is a rapid stream assessment methodology?

A rapid stream assessment methodology involves collecting data in the field on easily measured stream characteristics. A comparison of existing stream parameters can then be made against target values using a fast and reproducible process.

What are stream functions, functional groups, and sub-groups?

Stream functions are benefits that streams provide for people and wildlife. Each stream function (habitat, hydrology, water quality, and social/recreation) includes various characteristics that make up that function.

In this discussion, the stream functions are also referred to as functional groups, and the characteristics within each functional group are categorized into sub-groups.

of the 2015 Plan discusses the targets set and data collected to evaluate stream segments for stream channel and riparian corridor characteristics.

The habitat functional group in the 2009 SFI has two sub-groups: stream channel characteristics and riparian corridor characteristics. Table 3-12 lists the metrics that the County measured for these two sub-groups.

Table 3-12. Sub-groups and Metrics for the Habitat Functional Group

Functional Group	Sub-group (Characteristics)	Metric
Habitat	Stream Channel	Number of pools
		Number of boulders
		Water depth
		Clear fish passage
		Number of woody aquatic habitat structures
	Riparian Corridor	Width
		Percent shaded

Similar to the protocols developed for the 2009 SFI, the phab data collection included using the stream type classification system established by D.L. Rosgen, which is based on stream characteristics that result from relief, landform, and valley morphology (Rosgen and Silvey 1996). The County’s goal in classifying the streams and their habitat was to determine the quality of the overall stream ecology and critical areas that would require restoration.

Figure 3-40 depicts the Rosgen stream type classification system and the typical criteria ranges used to define each stream type.

Figure 3-40. Stream Type Delineative Criteria

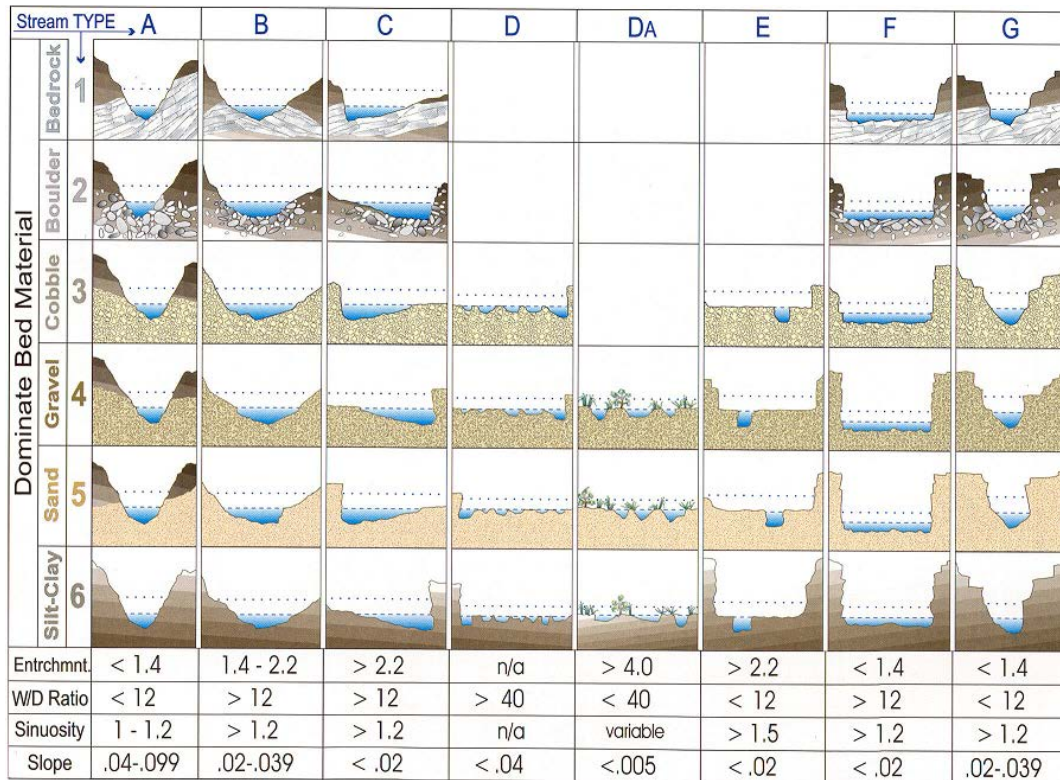

Source: Rosgen and Silvey 1996

Notes:

Entrchmnt = Entrenchment, a ratio; width of flood-prone area divided by the riffle width at bankfull

W/D Ratio = Width-to-depth ratio; width of bankfull riffle to maximum depth of bankfull riffle

Habitat and Reference Reach Sites

The County analyzed 37 stream sites in 15 sub-watersheds for their stream channel and riparian corridor characteristics. These sites, which represent about four miles of stream channel, were chosen using EPA’s Generalized Random Tessellation Stratified (GRTS) design tool. The GRTS design tool determined the aquatic resource sites for monitoring that were spatially-balanced within the eastern watersheds of the county. The County then further reviewed this potential list of sites for access, stream types, and the staff resources required to collect the data. This is the same method used to generate the macroinvertebrate sites and data was collected simultaneously.

The County also collected data from 25 reference reaches, which were determined by the County to represent healthy and functioning stream ecosystems for their particular stream type. Multiple potential reference sites were visited year after year, including major flood years and dry years. The sites selected as the 25 reference reaches displayed minimal variance in measurable form and changed the least out of the sites visited. This lack of change indicates stable stream form and thus a desirable reach to measure others against, especially those that share similar gradients, substrate, plan form, and valley types. For stream types F and G, the unstable stream types, County set the targets from the C stream type, which is the likely next stage in channel evolution from the unstable form. Measurements were made throughout these reference reaches to establish targets, such that stream reaches that met these targets represented healthy and functioning ecosystems.

For the purpose of calculating an average sub-group index score, if a specific metric was over 100% of the target, that metric score was capped at 100% so as to not overly influence the average sub-group index. For example, a section with a 230% of target for pools/mile was averaged with the other parameters using a value of 100%. Table 3-13 lists the stream channel and riparian corridor sub-group metrics that were recorded and the corresponding targets.

Table 3-13. Physical Habitat Index Metrics and Targets

Metric	Target by Stream Type					
	A	B	C	E	F	G
Stream Channel Sub-group						
Pools per mile	120	120	25/45 ^a	—	25/45 ^a	25/45 ^a
Boulders per mile	200	200	50	50	50	50
Wood structures in the stream representing aquatic habitat features per mile	210	210	100	210	100	100
Depth of water at lowest point (thalweg) (percentage of wetted width)	10	10	20	50	20	20
Number of fish barriers	0					
Number of culvert barriers	0					
Riparian Corridor Sub-group						
Riparian width (combined right and left banks as percentage of wetted width)	300	500	1,000	1,000	200	200
Stream shading (percentage of wetted width)	94	94	82	70	82	82

^a Targets for Type C, F, and G streams were identified based on the stream width that normally carries water (wetted width). The target of 25 pools per mile is for streams with a wetted width greater than 10 meters. The target of 45 pools per mile is for streams with a wetted width less than 10 meters.

Following the analysis methodology presented in the 2009 SFI, the County analyzed the phab data and prepared indices to describe each sub-group in order to provide a scientific basis for determining which stream reaches might require restoration to bring conditions closer to the targets that represent a healthy ecosystem. Table 3-14 below describes the overall habitat index scores and the stream channel and riparian corridor sub-group indices for each reach that the County analyzed. On this scale, 0 is a poor rating and 100 is an excellent rating. In addition to providing the index score, the cells are color-coded. The lowest index scores (darker red) scored 0-50, indicating stream reaches with the most impacted habitats, most potential to negatively affect water quality, and the highest potential need for stream restoration.

According to the County’s analysis, the sites where data was collected had an average habitat score of 69. The average scores for the stream channel and riparian corridor sub-groups were 66 and 71, respectively.

What is a thalweg?

A thalweg is the deepest point in a stream cross-section. It is also known as the low-flow channel.

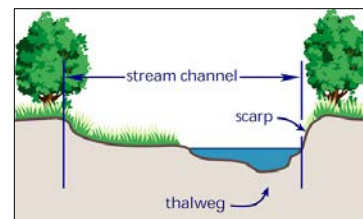

Source: SUNY 2014

Table 3-14. Habitat, Stream Channel, and Riparian Corridor Index Scores (2013)

Monitoring Locations			HABITAT INDEX										STREAM CHANNELS SUB-GROUP						RIPARIAN CORRIDOR SUB-GROUP		
Subwatershed	Stream Code	Stream Type	Length (meters)	% of target pools/mile	% of target boulder \$/mi	% of target fish barrier (culverts)	% of target other fish barriers	% of target woody habitat structures	% of target water depth at thalweg (as a % of wetted width)	Stream Channel sub-group Index	% of target combined riparian width (as a % of wetted width)	% of target shade cover	Riparian Corridor sub-group Index								
Corner Canyon Creek	CY_05.15	A4	150	50	232	815	100	8	27	5	57	77	43								
Lower Big Cottonwood Creek	BC_04.73	B3	240	48	11	114	1	100	6	56	46	76	51								
Lower Big Cottonwood Creek	BC_01.94	G4	360	26	10	18	100	100	3	15	41	22	11								
Lower Big Cottonwood Creek	BC_03.73	G4	200	78	72	1722	100	100	39	38	75	108	82								
Lower City Creek	CC_02.62	B4	200	59	74	455	100	33	5	36	58	97	59								
Lower Emigration Creek	EM_4.17	B5	150	86	215	279	100	14	36	85	73	101	100								
Lower Little Cottonwood Creek	LC_05.37	F5	200	55	268	4651	20	9	11	27	44	86	65								
Lower Little Cottonwood Creek	LC_01.37	G4	200	58	36	563	100	100	6	38	63	68	53								
Lower Mill Creek	MC_05.82	B4	160	61	293	1157	100	20	15	79	69	74	53								
Lower Mill Creek	MC_01.57	F4	252	51	114	2299	50	33	10	46	57	42	45								
Lower Parleys Creek	PC_04.81	B3	160	71	25	256	100	50	28	5	51	81	90								
Lower Parleys Creek	PC_05.53	B3	200	79	40	1151	100	25	26	75	61	96	98								
Lower Parleys Creek	PC_05.13	F3	160	85	425	3822	100	50	56	49	76	113	95								
Lower Parleys Creek	PC_04.11	F3	200	76	232	3186	100	100	0	26	71	112	80								
Lower Red Butte Creek	RB_01.75	B4	150	60	98	333	100	25	7	64	66	101	55								
Lower Red Butte Creek	RB_02.68	B4	100	46	0	4949	100	50	4	42	42	101	50								
Upper Big Cottonwood Creek	BC_21.24	B3	160	59	218	4189	100	25	28	54	68	191	50								
Upper Big Cottonwood Creek	BC_10.54	C4	280	47	358	10794	100	9	38	19	61	37	33								
Upper Emigration Creek	BR_14.44	A3	150	77	89	799	100	5	8	124	67	89	85								
Upper Emigration Creek	EM_06.36	B4	150	83	125	880	100	100	6	89	82	84	84								
Upper Emigration Creek	KL_00.07	B4	150	56	232	477	33	25	21	58	56	84	57								
Upper Midas/butterfield	BF_05.18	B4	150	85	134	123	100	50	20	85	76	88	94								
Upper Mill Creek	MC_09.30	A3	160	74	159	528	100	100	19	63	80	97	68								
Upper Mill Creek	MC_10.46	A3	240	80	39	1241	100	100	147	57	83	88	77								
Upper Mill Creek	PF_01.00	A3	150	74	206	1883	100	20	39	45	67	113	81								
Upper Mill Creek	MC_12.62	B4	180	88	216	608	100	50	41	67	76	103	100								
Upper Parleys Creek	MD_03.80	B3	120	90	145	939	100	100	46	103	91	80	90								
Upper Parleys Creek	PC_05.89	B3	200	67	349	1002	100	100	22	87	85	0	50								
Upper Parleys Creek	PC_05.89	B3	160	83	201	553	100	100	27	90	86	105	79								
Upper Parleys Creek	PC_06.52	B3	200	83	154	2297	100	10	31	66	68	96	97								
Upper Parleys Creek	PC_15.51	B3	150	77	206	284	100	50	5	134	76	96	78								
Upper Parleys Creek	SC_01.05	B3	120	75	78	764	33	9	27	56	51	98	99								
Upper Parleys Creek	MD_04.55	B4	150	50	18	343	100	100	27	83	71	48	28								
Upper Parleys Creek	SC_00.14	B4	120	86	224	805	50	5	94	84	72	104	100								
Upper Parleys Creek	PC_14.40	E4	180	63	0	4077	100	33	37	13	47	102	79								
Upper Red Butte Creek	RB_07.65	B4	150	87	134	1153	100	11	46	115	76	97	99								
Upper Rose Creek	RC_09.87	E4	90	61	0	5007	50	33	3	27	36	71	86								

Color Key: 0-50 51-80 80->100

Summary

The physical habitat data collection and analysis produced the following general results:

- The County needs to re-establish the stream types for all locations along streams. Existing stream type analysis was performed using remote sensing techniques and needs to be verified for accuracy.
- The analyzed sites in the lower watersheds have an average habitat score of 62, compared to the average habitat score of 74 for the analyzed sites in the upper watersheds.
- 25 of the 37 sites require stream channel improvements, based on their having scores less than 75.
- 16 of the 37 sites require riparian corridor improvements, based on their having scores less than 75.

The County will use these data to help select stream segments for restoration. There might be opportunities to combine several of the sites through more-comprehensive restoration efforts, which would allow the County to address hydraulic and water quality functions at the same time.

3.7 Climate Change

Climate change has the potential to affect water cycles. Potential water quality-related effects of climate change include warmer creek and river waters, changes in the amount and distribution of rainfall and snowfall, and more intense rainfall and storms.

Increases in runoff and flooding can reduce the quality of water and can damage the infrastructure used to treat, transport, and deliver water. Increases in heavy precipitation events could cause problems for the water infrastructure, such as additional flow through the storm drain system increasing stream bank erosion as a result of increased volumes of water. Heavy downpours can increase the amount of stormwater runoff into rivers and lakes, washing sediment, nutrients, pollutants, trash, animal waste, and other materials into waterbodies and making them unusable, unsafe, or in need of increased water treatment.

Scientific knowledge concerning naturally occurring and potentially human-influenced changes and variations in the earth's climate is rapidly increasing. Much scientific research has occurred since the publication of the 2009 Plan, and additional, detailed information is available. This available information includes specific projections of future meteorological and hydrological conditions in Salt Lake County.

This section describes available data on Salt Lake County climate projections; summarizes the conclusions from several recent, relevant climate change studies; and describes in general terms the expected effects of climate change on watershed functions in Salt Lake County.

2009 Plan Summary

The 2009 Plan reviewed past county weather data (1995–2005) in terms of annual temperature and average annual precipitation in the Salt Lake Valley and the surrounding mountains. The 2009 Plan summarized findings from the Blue Ribbon Advisory Council on Climate Change's

(BRAC) 2007 report and related these findings to how the forecasted trends could affect the county watershed functions of habitat, hydrology, water quality, and social/recreation.

Local Climate Conditions Predicted by Global Climate Model Simulations

The Consolidated Model Intercomparison Project (CMIP) maintains a standardized, online database of global climate model (GCM) simulation results created by climate scientists around the world (LLNL 2015). The newest set of model simulation results (CMIP5) provides data for specific global locales, or cell grids, based on a 1/8-degree scale. These results include projections for Salt Lake County. The model simulation results document various simulated meteorological data representing simulated historical (past) and future conditions. The available CMIP5 simulated temperature, precipitation, and runoff data are of greatest interest to the County in terms of water quality and the county's watersheds.

What is a cell grid?

In this global climate model simulation, a cell grid is an area of land surface 1/8th of a degree of latitude (8.6 miles) by 1/8th of a degree of longitude (6.6 miles), or an area of 57 square miles.

In order to analyze how the climate change model simulation results apply to the county's water resources, the County chose two cell grid locations from the CMIP5 database: one for the low (valley) elevations in Salt Lake County and one for the high (mountain) elevations. These locations represent the natural climate variability between the low and high elevations.

- The valley cell grid location is near the Salt Lake City International Airport (**airport location**). In the graphs in Section 3.7, model simulation results for the airport location are shown in dark blue circles.
- The mountain cell grid location is near the summits of Little and Big Cottonwood Canyons (**mountain location**). In the graphs in Section 3.7, model simulation results for the mountain location are shown in light blue squares.

The CMIP5 database provides simulated meteorological and hydrological model simulation results for 231 temperature scenarios and 97 precipitation and runoff scenarios. These model simulation results are presented as monthly data for a period of simulation from 1950 through 2099. One convenient way to summarize the effects of climate change from these results is to compare simulated averages from 1950 to 1999 (**historical**) with simulated averages from 2030 to 2079 (**future**). The differences then represent 80 years of climate change. Rather than review the model simulations for average forecasts or the most extreme forecasts, the County chose to evaluate two basic scenarios as a way to bracket the results: a **dry scenario** model simulation that predicts less rainfall and less runoff than average, and a **wet scenario** model simulation that predicts more rainfall and more runoff than average.

The following four subsections summarize the model simulation results for the three meteorological parameters (temperature, precipitation, and runoff) for all the GCM simulation results, and the selected dry and wet scenarios at each of the two selected locations (airport location and mountain location).

The first three subsections include graphs that summarize all of the data about temperature, precipitation, and runoff to visually explain the data. On these graphs, blue dots and squares indicate the results from *all* scenarios tested. Red indicates the dry-scenario projections for airport and mountain locations, and green is used to indicate the wet-scenario projections.

Graphs in the last subsection provide a more-detailed analysis of monthly runoff, by comparing monthly and average data for each location under each of the two (dry and wet) scenarios.

Monthly Surface Temperature

Figure 3-42 shows the modeled change in average monthly temperature. The figure shows 231 squares (airport location) and 231 circles (mountain location) that display the range of the simulated predicted temperature change. *Each circle or square represents the change in average monthly surface temperature from the historical period to the future period for the 231 CMIP5 temperature scenarios.* The figure also highlights the selected dry-scenario (red) and wet-scenario (green) model simulation results for the airport and mountain locations.

Figure 3-42. Model Simulation Results for Change in Monthly Temperature at Airport and Mountain Locations

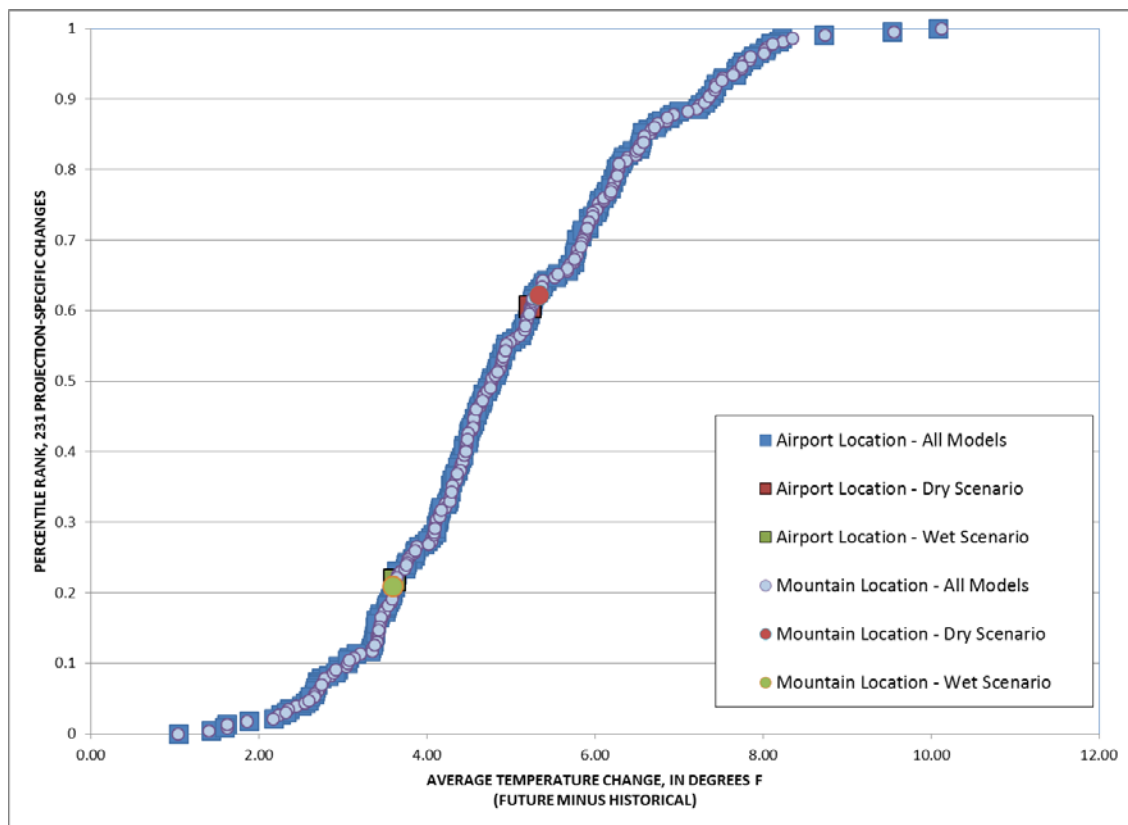

Figure 3-42 shows that the predicted average temperature change is essentially the same for the airport and mountain locations, since the model simulation results for the two locations overlap. The average monthly temperature is projected to increase by 1 to 10 degrees Fahrenheit (°F), with most of the model simulations showing a change of about 4°F to 6°F at both locations.

For the specific scenarios considered in this analysis, the predicted changes in future monthly temperatures are the same:

- Airport and mountain locations
 - Dry scenario: 5°F increase
 - Wet scenario: 3.6°F increase

Monthly Precipitation

Figure 3-43 shows the modeled change in monthly precipitation. The figure shows 97 squares (airport location) and 97 circles (mountain location) that display the range of simulated predicted change in monthly precipitation. *Each circle or square represents the change in monthly precipitation in inches from the historical period to the future period for each of the 97 CMIP5 precipitation scenarios.* The figure also highlights the selected dry-scenario (red) and wet-scenario (green) model simulation results for the airport and mountain locations.

Figure 3-43. Model Simulation Results for Change in Monthly Precipitation at Airport and Mountain Locations

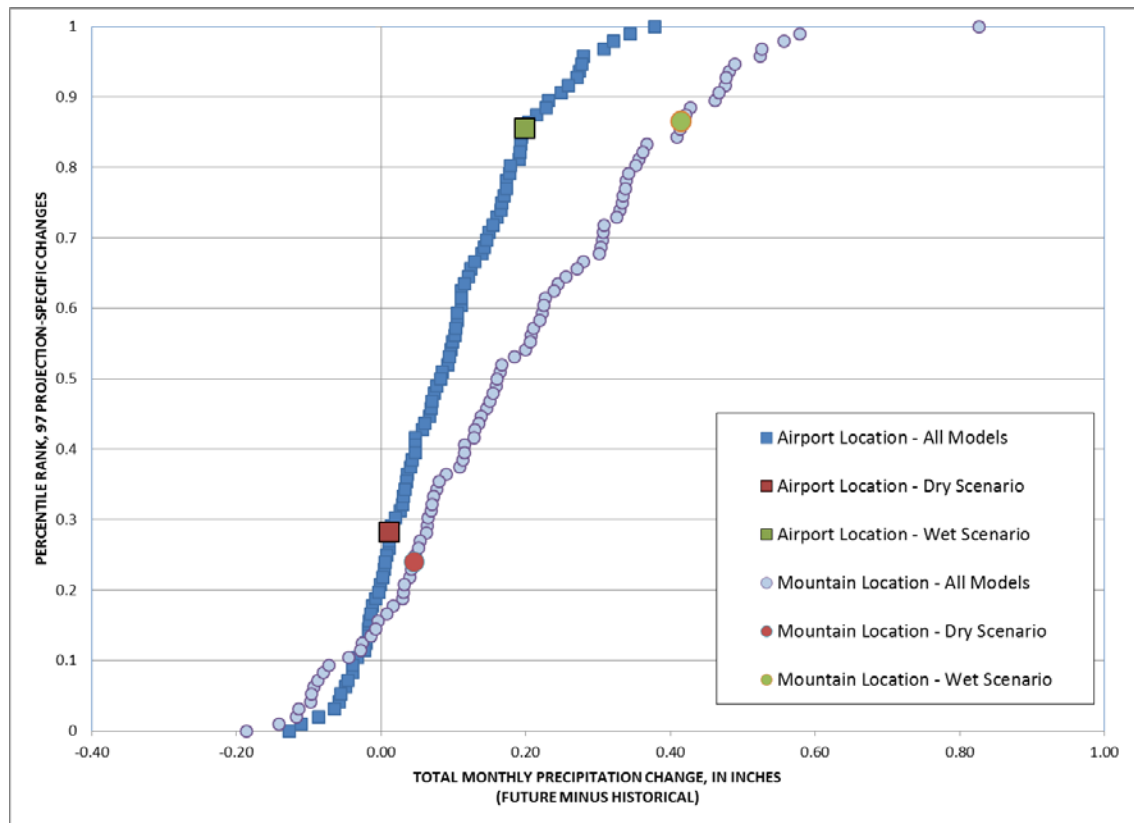

Figure 3-43 shows that most of the model simulations predict a 0.0-to 0.2-inch increase in monthly precipitation at the airport location. At the mountain location, most of the model simulations predict a 0.0-to-0.4-inch increase, almost twice the change in average monthly precipitation as the airport.

For the specific scenarios considered in this analysis, the predicted changes in future monthly precipitation are:

- Airport location
 - Dry scenario: 0.13-inch decrease
 - Wet scenario: 0.36-inch increase
- Mountain location
 - Dry scenario: 0.2-inch decrease
 - Wet scenario: 0.8-inch increase

Monthly Runoff

Figure 3-44 shows the modeled change in monthly runoff. The figure shows 97 dots (airport location) and 97 squares (mountain location) that display the range of the simulated predicted change in monthly runoff. Each dot or square represents the change in monthly runoff in inches from the historical period to the future period for each of the 97 CMIP5 runoff scenarios. The figure also shows the selected dry (red) and wet (green) scenario model simulation results for the airport and mountain locations.

Figure 3-44. Model Simulation Results for Change in Monthly Runoff at Airport and Mountain Locations

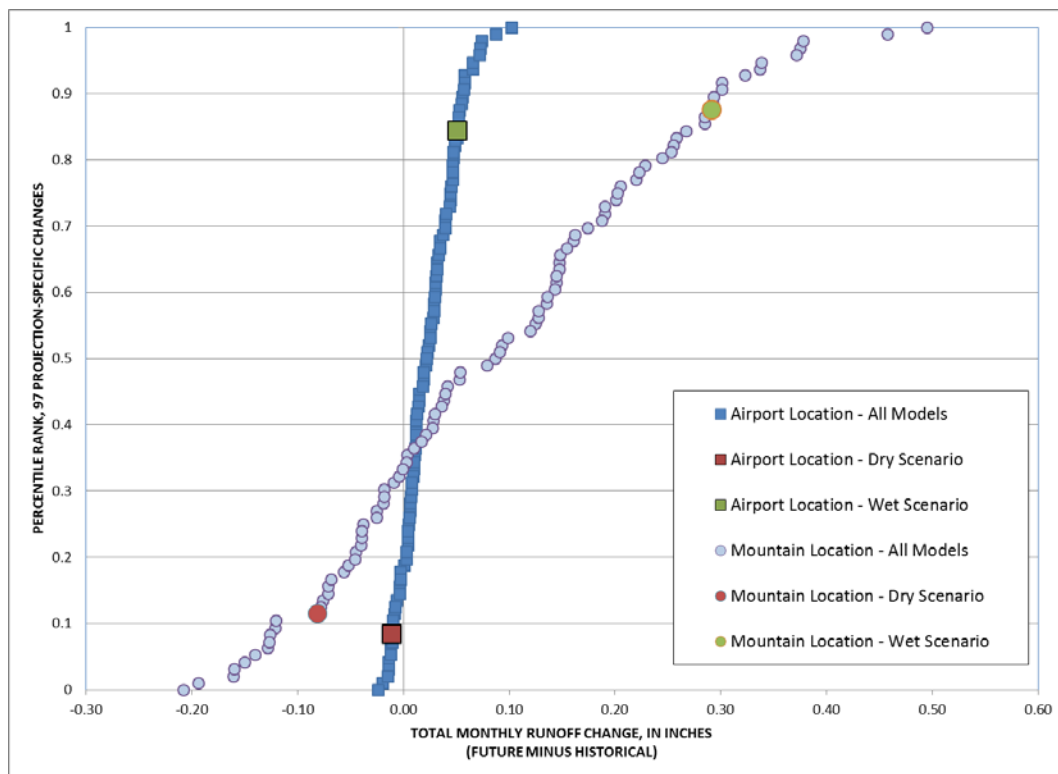

Figure 3-44 shows that average monthly runoff is predicted to increase by 0.0 to 0.04 inch at the airport location. At the mountain location, most of the model simulations show a 0.05-inch decrease to a 0.25-inch increase, almost twice the change in runoff as at the airport location.

For the specific scenarios considered in this analysis, the average predicted changes in future monthly runoff are:

- Airport location
 - Dry scenario: 0.02-inch decrease
 - Wet scenario: 0.1-inch increase
- Mountain location
 - Dry scenario: 0.2-inch decrease
 - Wet scenario: 0.5-inch increase

Simulated Effects of Wet and Dry Scenarios on Monthly Runoff at Low and High Elevations

The data shown in Figure 3-44 indicate that the monthly change in runoff is highly variable when all 97 simulations are considered. The County conducted further analysis to better understand the potential effect the changes could have for the airport and mountain locations under each of the two selected model scenarios (dry and wet scenarios). The selected dry scenario is based on the results from a specific model simulation called *cesm1-cam5.1.rcp45*,¹ and the wet scenario is based on the results from a specific model simulation called *gfdl-esm2g.1.rcp60*.²

Overall, the model results show that the predicted changes for the wet scenario at both the airport and mountain locations are of a larger magnitude than the predicted changes for the dry scenario. This means that the wet scenario predicts higher increases in precipitation and runoff than the dry scenario predicts decreases in those same parameters.

Dry Scenario. Figure 3-45 and Figure 3-47 show hydrographs of the simulated effects for average monthly runoff for the dry scenario at the airport and mountain locations. For the airport location, which is addressed in Figure 3-45³ runoff is simulated to be very low (less than 2.5 inches per year). The climate change effect for this location under the dry scenario is a relatively minor 5% (0.12 inch per year) decrease in runoff volume and a slight change in the seasonal pattern. However, at the mountain location shown in Figure 3-47 (where simulated runoff averages more than 15 inches per year), the annual average change in runoff volume is a decrease of 0.97 inch per year (-6%), and the peak of the runoff is reduced and 1 month earlier.

What is a hydrograph?

A hydrograph is graph showing the rate of flow (discharge) versus time at a specific point. A runoff hydrograph typically consists of a fairly regular lower portion that changes slowly throughout the year and a rapidly fluctuating component that represents the immediate response to rainfall.

¹ National Center for Atmospheric Research GCM, with relatively central emissions and development assumptions.

² National Oceanic and Atmospheric Administration, Geophysical Fluid Dynamics Laboratory GCM, with relatively central emissions and development assumptions.

³ The CMIP5 runoff simulation results are not well calibrated in the Salt Lake County region. Individual simulations cannot be used directly, but the simulated change in runoff provides valuable information regarding the effects of climate change.

Wet Scenario. Figure 3-46 and Figure 3-48 show hydrographs of the simulated effects for average monthly runoff for the wet scenario at the airport and mountain locations. The results show that the simulated climate change effects for the wet scenario are much different at the two selected locations. Figure 3-46 shows that, at the airport location, average monthly runoff is simulated to increase by 26% (for an annual average increase of 0.62 inch per year), with increases throughout the seasonal pattern. At the mountain location, in Figure 3-48, the simulated climate change effect is an increase in the average annual runoff volume of 3.5 inches per year (23%), with significantly increased and earlier winter and spring runoff.

Figure 3-45. Simulated Effect for Average Monthly Runoff Hydrograph - Airport Location with the Dry Scenario

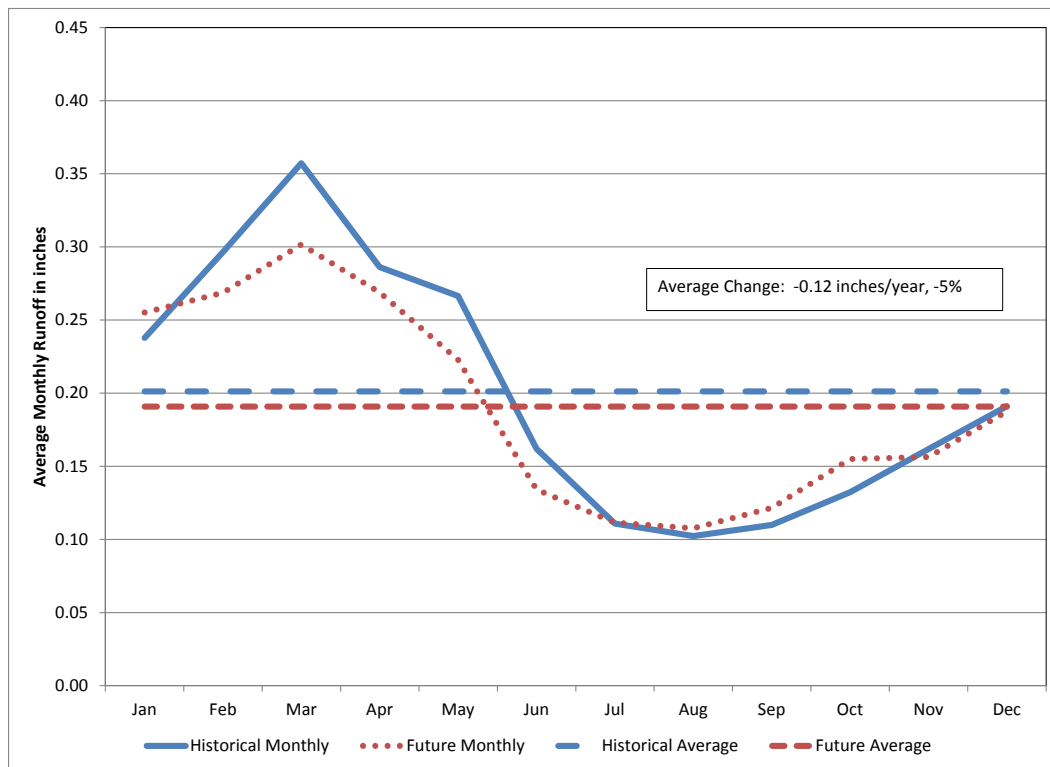

Figure 3-46. Simulated Effect for Average Monthly Runoff Hydrograph - Airport Location with the Wet Scenario

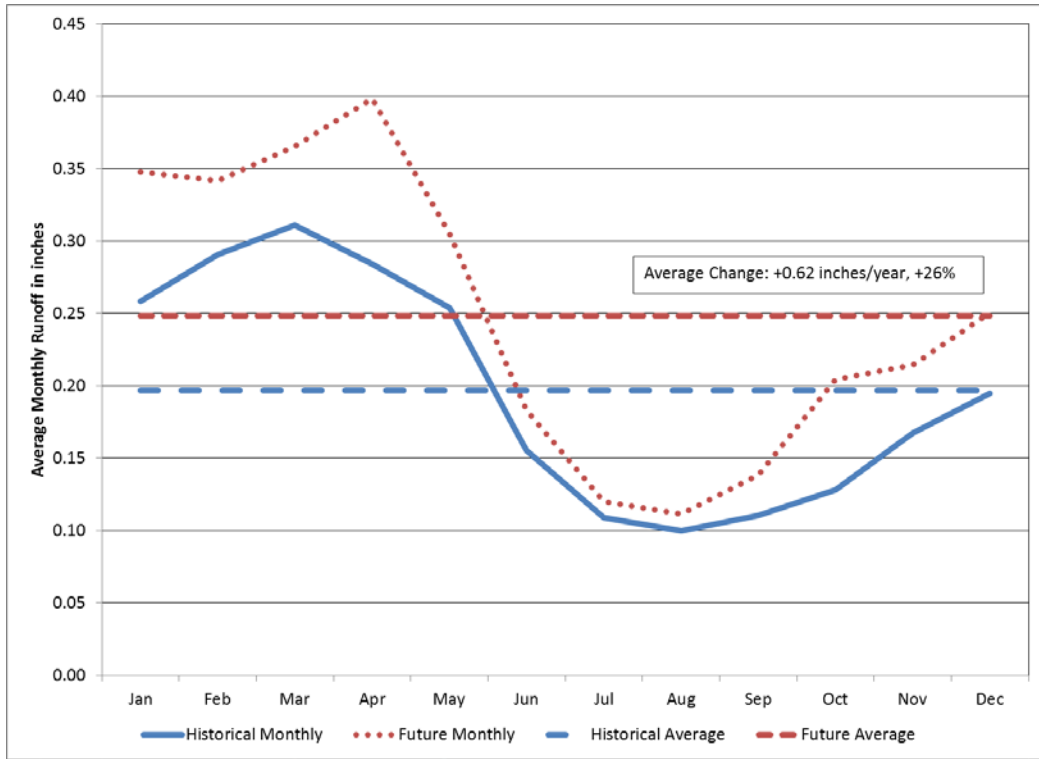

Figure 3-47. Simulated Effect for Average Monthly Runoff Hydrograph - Mountain Location with the Dry Scenario

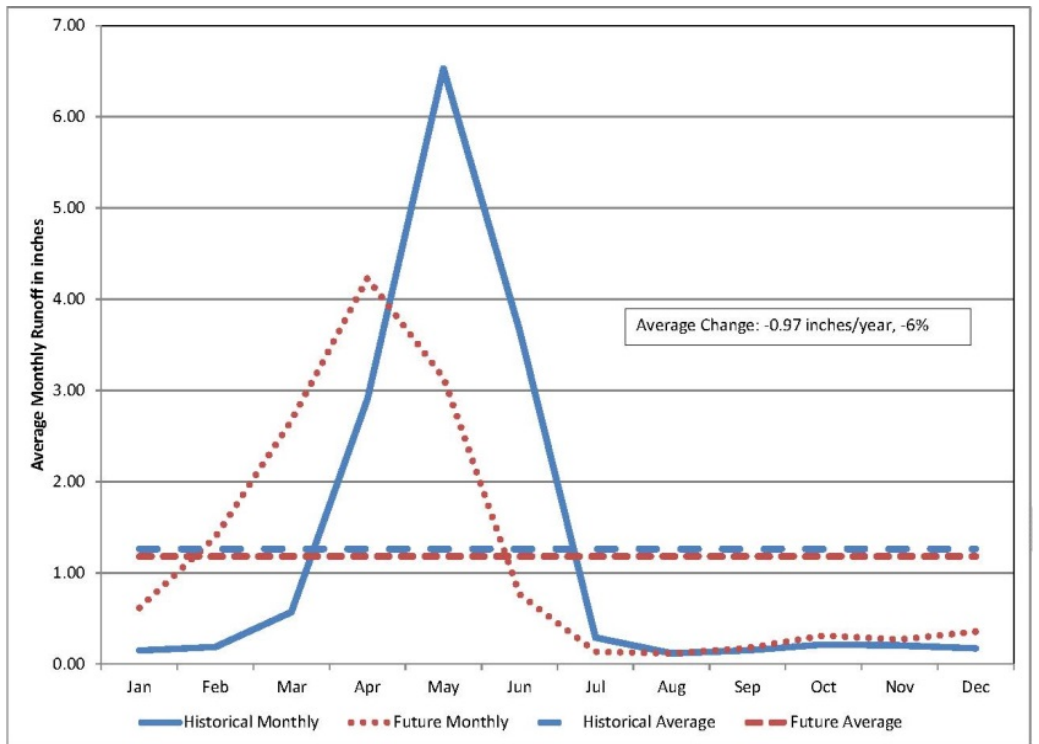
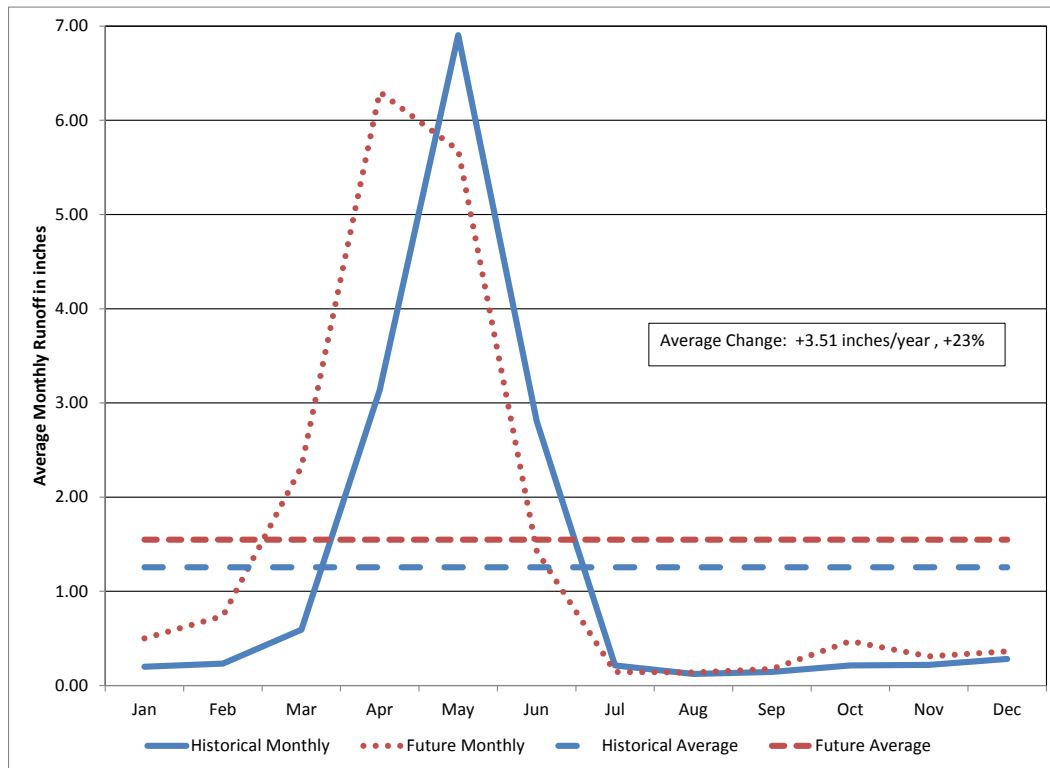

Figure 3-48. Simulated Effect for Average Monthly Runoff Hydrograph - Mountain Location with the Wet Scenario



Other Relevant Local and Regional Studies

Other local and regional studies provide additional information about how climate change could affect resources in Salt Lake County. This section summarizes the results of three such studies.

Vulnerability Assessment (Intermountain Adaptation Partners). The U.S. Forest Service, Intermountain Region, has started a collaboration called the Intermountain Adaptation Partners (IAP; U.S. Forest Service 2015). The IAP will gather available scientific information to assess the sensitivity of natural resources to climate change and develop science-based adaptation strategies to mitigate adverse effects.

The IAP is currently conducting a region-wide climate change vulnerability assessment of priority resources (species, ecosystems, and ecosystem services). The Wasatch Front is one of the IAP’s focus areas. Although the vulnerability assessment focuses on national forests, it should provide valuable information on climate change effects that can be adapted to other conservation strategies and information on habitat adaptation and restoration planning. The IAP will also provide training to resource specialists who can apply climate change lessons to land-management strategies throughout the region.

Because a substantial part of the county is national forest, future updates of this integrated watershed plan should consider the vulnerability assessment information, especially as it pertains to long-term changes in land-management strategies that could affect water quality in the east-side upper and lower sub-watersheds.

Water Supply Variability Study (Central Utah Water Conservancy District). The Central Utah Water Conservancy District (District) is responsible for completing and managing the Central Utah Project, which develops water for irrigation, municipal and industrial supplies, environmental stream flows, and power generation. The project also provides recreation, fish and wildlife, flood control, water conservation, and water quality benefits within its service area, which includes Duchesne, Wasatch, Utah, and Salt Lake Counties. The District is conducting a water supply variability study that considers the effects of climate change on water supply reliability (Lambson 2015). The study seeks to improve the reliability of the Central Utah Project water supply by:

- Evaluating the combinations of meteorological and operational conditions that stress the system
- Understanding the sensitivity of the District’s system to drought conditions that are more adverse than those that have been observed (including those due to potential climate change)
- Developing a tool to help operate the system in advance of adverse conditions

The study’s preliminary conclusions are that the most extreme (driest) climate change effects could cause the Central Utah Project system to experience water supply shortages.

The County can consider the study’s findings about threats to regional water supplies and how future water supply system operations might relate to long-term water quality management as part of subsequent integrated watershed plan updates.

Hydrologic Modeling Study (Salt Lake City). The Salt Lake City Department of Public Utilities recently completed a hydrologic modeling study to examine the effects of future climate-driven hydrologic changes on water supply planning (Bardsley and others 2013). The study examines the consequences of climate change on the reliability of Salt Lake City’s water supply from the four Wasatch Front Watershed areas, primarily from upper Big and Little Cottonwood Creeks. The modeling results, focused on the simulations reflecting drought or drier conditions, indicate that temperature changes alone will lead to earlier runoff and reduced runoff volume. The study predicts surface water flow reductions of 21.8% to 26.5% per 1 °F of warming, with the largest flow reductions predicted to occur during the high-water-demand months of May through September. The study shows that changes in precipitation affect hydrologic response even more strongly, with a 1.9% reduction in runoff for every 1% reduction in precipitation.

For future integrated watershed plan updates, the County can work with Salt Lake City to identify how potential changes in surface water flows and changes in water supply management could address water quality in the event of significant water supply challenges.

Summary of Climate Model Scenarios

The detailed simulated effects of projected climate change presented in this 2015 Plan, as well as other local recent studies, suggest that climate change–related effects could include increases in temperatures and changes in precipitation and runoff patterns throughout the county. The results of recent studies support a general consensus regarding the nature of hydrologic change, although detailed results show a wide range of possible future predicted effects.

Specific dry- and wet-scenario model simulation results provide information about potential climate change effects at two locations in the county (the airport and mountain locations). The following list summarizes the results of the simulations for two scenarios at each of the two locations.

Dry scenario:

- Airport location
 - 5°F increase in average temperature
 - Slight decrease in monthly precipitation (–0.13 inch)
 - Decrease in annual volume of runoff (–5%)
 - Slight change in the seasonal pattern of peak runoff
- Mountain location
 - 5°F increase in average temperature
 - Small decrease in monthly precipitation (–0.2 inch)
 - Decrease in annual volume of runoff (–6%)
 - Peak runoff would be reduced and 1 month earlier

Wet scenario:

- Airport location
 - 3.6°F increase in average temperature
 - Small increase in monthly precipitation (+0.36 inch)
 - Significant increase in annual runoff volume (+26%)
 - Large increase in monthly runoff and winter snowmelt runoff
- Mountain location
 - 3.6°F increase in monthly temperature
 - Higher monthly precipitation (+0.8 inch)
 - Significant increase in annual runoff volume (+23%)
 - Earlier and increased volume of winter snowmelt runoff

In general, the predicted changes for the wet scenario are of a larger magnitude than the predicted changes for the dry scenario for both the airport and mountain locations. This means that the wet scenario predicts higher increases in precipitation and runoff than the dry scenario predicts decreases in those same parameters.

Taken as a whole, the GCM simulation results tend to indicate that Salt Lake County will experience higher temperatures and receive more precipitation and an increase in runoff volume

under the wet scenario than under historical conditions. Whether these predicted increases will result in significant changes to peak stream flows is not known.

Most of the recent local studies conducted on evaluating the vulnerability of the county's water supply due to predicted climate change have focused on the reliability of drinking water sources during drought or dry conditions and not the wetter scenarios. For the two studies that have generated some results, both indicate that, under extremely dry conditions, increased temperatures could reduce the available water supply. In the case of the Hydrologic Modeling Study completed by Salt Lake City, the findings about runoff are similar to the County's findings regarding reduced runoff under dry conditions (Bardsley and others 2013).

Climate Effects on Watershed Functions

The projected changes in temperature, precipitation and runoff are expected to produce the following general effects on Salt Lake County's watershed functions:

- **Habitat.** Changes in temperature and moisture (extreme droughts and floods) will influence plant species over a period of decades. Species that are drought-tolerant could thrive in the absence of moisture and in higher temperatures. Aquatic habitat could transform to adjust to the change in runoff patterns of the perennial streams.
- **Hydrology.** The potential for earlier, more-rapid spring snowmelt could increase peak flows, which would require larger flood-control structures and stream capacity to carry these increased flows. These events could increase the discharge of pollutants due to increase stormwater runoff and instream bank erosion. Changes in extreme runoff events are postulated by climate researchers but are not fully known nor accurately predicted by global climate models.
- **Surface Water Temperature and Aquatic Ecosystem Function.** Increasing air temperature along with decreased runoff will promote increased surface water temperatures. These increased surface water temperatures could lead to increased algal growth and decay and will likely lead to lower concentrations of dissolved oxygen in certain stream reaches, which could affect the extent and diversity of instream aquatic life.
- **Recreation.** Higher temperatures in the winter could reduce the availability of winter recreational opportunities in Salt Lake County that rely on snowpack in the mountains. Higher temperatures in the summer could require more water supply for irrigation and could change the nature of the water in the streams and the Jordan River where there are many recreational opportunities.

Scientific understanding of this important issue is increasing rapidly. Because climate change could affect watershed functions in Salt Lake County, future integrated watershed plan updates should continue review of the latest information. The County should continue to collaborate with other agencies regarding change in management strategies to reduce vulnerabilities and to understand the potential water quality impacts of those strategies is reasonable.

3.8 Water and Energy

Water and energy systems are interdependent. On both national and local levels, the relationship between water and energy has become a focus because providing clean water and treating wastewater requires energy and because energy production relies on water resources. This relationship is known as the water-energy nexus. EPA estimates that, on a national basis, 3–4% of electricity generated is used to provide drinking and wastewater services. Further, within municipalities, these services are estimated to account for 30–40% of the total municipal energy use (EPA 2015).

The competition for reliable water supply for energy production, drinking water supply, mining, and industrial and agricultural use, as well as to support watershed ecological systems, has been and continues to be a highly debated and regulated topic.

This section discusses opportunities for reducing water and energy demands by identifying the choices and technologies that are available to energy and water users. Bringing the connection of water and energy into the discussion in this 2015 Update will provide the County with choices to manage its watersheds with resiliency to ensure that watersheds continue to function through times of change, whether that change is due to climate effects or to increased demands due to growth.

How We Use Energy for Water

Energy is required to deliver water services, from clean drinking water and reliable stormwater systems to irrigation and wastewater treatment. As water demands and the associated energy demands required to provide water to county users increase, the County will need to address water infrastructure and management systems and consider sustainable energy sources and more-efficient systems. Salt Lake has been working on the evaluation and improvement of the energy efficiency of its culinary water system. In addition, Salt Lake City is in the beginning stages of evaluation and implementation of the other parts of its system, including the sewer and storm drain systems.

Drinking Water Cycle. In the simplest terms, the drinking water cycle for Salt Lake County begins with a local source of water (snowmelt or groundwater) that is collected and conveyed to either irrigation customers or to the county’s four water treatment facilities for drinking water customers. After it is collected and/or treated, drinking water is distributed through a system of tanks and pipes to customers.

In Salt Lake County, imported water (water brought into the county watershed) is also collected and stored in reservoirs and lakes outside the county. Then, using systems of canals and pipelines, the water is conveyed to water treatment facilities and drinking water customers or directly to agricultural and industrial users. **Wastewater Cycle.** The wastewater cycle begins once water is used by drinking-water customers. Wastewater generated within the county is collected using a network of pipes and pump stations and is conveyed to one of the county’s five wastewater treatment facilities (located in Magna, West Valley City, Salt Lake City, South Jordan, and Riverton). The discharge of treated wastewater is regulated by the State of Utah, and treated wastewater is discharged to receiving waters near the treatment facilities (for example, water

treated at the South Valley Water Reclamation Facility discharges to the Jordan River consistent with a permit issued by the State of Utah). Currently, limited amounts of the treated water leaving the wastewater treatment facilities are reused.

The water used for agricultural irrigation is generally untreated surface water. Unused irrigation water is directly discharged (without being treated) to receiving waters in the form of tail water or return water.

Stormwater Cycle. The stormwater cycle begins with precipitation (rain or snow) that falls in urbanized areas of Salt Lake County and is collected by a storm drain system. The storm drain systems consist of temporary storage ponds and pipes that directly discharge to receiving waters without any formal water treatment. In some cases, pump stations are required to lift (move) the stormwater from a geographic low point (such as a temporary storage pond) to a final discharge point.

Precipitation that falls in undeveloped areas, such as open space in the foothills, infiltrates into the ground or can flow aboveground, depending on the location and soil conditions. This type of stormwater follows natural ground topography and contributes to groundwater recharge or collects in streams and creeks and eventually flows to the Great Salt Lake.

How We Use Water for Energy

Over the last 5 years, about 78% of the energy produced in power plants in the United States has been generated by thermoelectric systems using fossil fuels. In the same period, renewable sources were used to generate about 11%, and nuclear power generation accounted for about 10% of the total energy produced (EIA 2015).

Thermoelectric power generation using fossil fuels is the most common type of power production in Utah. Figure 3-49 shows the breakdown of Utah energy production by source. Fossil-fuel sources used for thermoelectric power generation in Utah include natural gas, coal, and oil. Renewable energy sources include solar, wind, biomass, geothermal, and hydroelectric; these combine to provide about 1.9% of the total 2012 energy production in Utah. In addition to existing energy sources, Utah energy producers are developing oil shale, oil sands, and uranium sources, all of which can be used to produce energy for consumers. Nuclear power generation is not currently used in Utah.

What are tail water and return water?

Most of the agricultural land in Salt Lake County is flood-irrigated. Irrigation water that doesn't soak into the soil eventually flows back into a river or stream. This unused irrigation water is referred to as tail water or return water.

Figure 3-49. Utah Energy Production (2012)

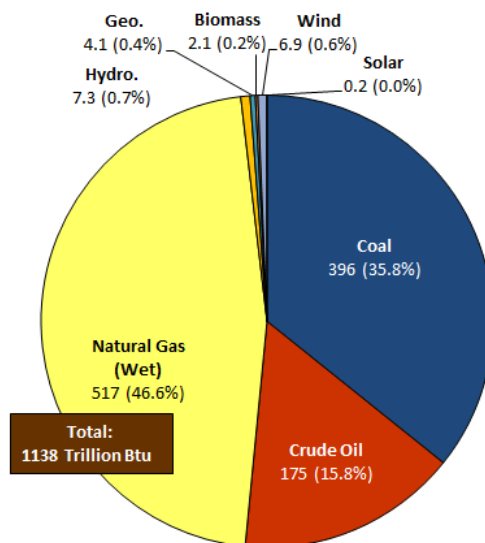

In Utah, the Governor’s Office of Energy Development estimates the energy sector to be a \$20.9-billion industry, one that produced 1,138 trillion British thermal units (Btu) in 2012. Of the energy produced in Utah, about 27% is exported (GOED 2015).

Thermoelectric Power. Fossil-fuel-fired thermoelectric power plants consume about 132,086 million gallons of fresh water per day in the United States (IEEE 2008). Technology has been improving in recent years, and the 2010 thermoelectric water withdrawals were 20% less than estimates for 2005. In 2010, total withdrawals for thermoelectric power in the United States accounted for 45% of total water withdrawals, 38% of total freshwater withdrawals, and 51% of fresh surface-water withdrawals for all uses (USGS 2014a).

Thermoelectric power production is water-intensive because, during production, a condenser is used to remove excess heat from the cycle, a process that requires using cooling water. Used cooling water can be discharged to a nearby stream or river, but most power plants evaporate a portion of the cooling water and transfer the excess heat into the air via evaporation using cooling towers. Evaporation minimizes the environmental effects of withdrawing an abundant amount of water and quickly dumping hot water back into a stream or river (U.S. Department of Energy 2003).

In Utah, thermoelectric plants generate about 30,000 kilowatt-hours year, using about 0.5 gallon of fresh water is evaporated per kilowatt-hour of electricity consumed at the point of end use compared to hydroelectric power generation which generates about 700 kilowatt-hours per year and loses about 70 gallons per kilowatt-hour to evaporation (Torcellini and others 2003). One kilowatt hour is enough energy to power an energy-efficient refrigerator for about 8 hours.

The type of cooling tower system used for evaporation affects overall water consumption: *once-through* cooling refers to cooling systems in which water is circulated through heat exchangers and then returned to the source, whereas *recirculation cooling* refers to cooling systems in which water is circulated through heat exchangers, cooled using ponds or towers, and then recirculated.

In 2010, Utah-based thermoelectric power generation used 80.6 million gallons per day (MGD) which was used to generate about 38,900 megawatt-hours of electricity. In 2010, power-

generation facilities in Salt Lake County generated energy using once-through and recirculation cooling systems. Total water withdrawals for thermoelectric power generation were 3.98 MGD, which was used to generate 1,559 megawatt-hours. Based on the population in 2010, the per-capita amount of water used for thermoelectric power generation was about 0.001 MGD. This rate has not changed over the last 10 years (USGS 2010, 2014b). About 88% of the thermoelectric power generated in the county in 2010 was generated using recirculation cooling (USGS 2014b).

Hydroelectric Power. Hydroelectric power generation requires a lot of water and a lot of space to generate significant amounts of power. Hydropower is water-intensive because it requires large volumes of water to generate electricity, but very little water is consumed in the process, since most of the water is returned to its native stream or river. Hydropower water losses are primarily due to evaporation from reservoirs that are upstream of hydropower dams that are part of hydropower plants (across the US, the average loss of about 18 gallons per kilowatt-hour that is used by the end consumer (Torcellini and others 2003).

In the early part of the 20th century, hydroelectric plants supplied almost half of the nation's power, but this number has dropped to about 9% (U.S. Department of Energy 2003; USGS 2014c). Because of the geographic, topographic, and environmental limitations to building new large-scale hydropower facilities, the future trend for the use of hydropower is likely to focus on small-scale plants that can generate electricity for a single community (USGS 2014c). Pacificorp and the city of Murray in Salt Lake County operate hydropower facilities within the county. Murray operates a small hydropower facility on Little Cottonwood Creek.

Solar Power. Solar photovoltaic cells do not use water for generating electricity. However, like all thermal electric plants, concentrating solar thermal plants require water for cooling. The amount of water use depends on the plant design, the plant location, and the type of cooling system.

Cooling systems for solar power plants include wet-recirculating, once-through technology with cooling towers, and dry-cooling technology. Wet-recirculating systems withdraw between 600 and 650 gallons of water per megawatt-hour of electricity produced. Plants with once-through cooling technology have higher levels of water withdrawal but lower total water consumption (because water is not lost as steam). Dry-cooling technology can reduce water use by about 90%, but the tradeoffs for these water savings are higher costs and lower efficiencies (UCS 2015).

Many of the regions in the United States that have the highest potential for solar energy also tend to be those with the driest climates. Utah is one such place, so consideration of large-scale solar has to be weighed against water supplies and future water needs.

In 2012, only a fraction of the energy produced in Utah was via solar power. In 2014, the solar-generation capacity of all solar power generators in the state was 39 megawatts (SEIA 2015). Notable solar installations in Salt Lake County include the Salt Palace Convention Center in Salt Lake City, which has a 1.65-megawatt system, and the IKEA furniture store in Draper, which has a 1-megawatt system. These systems are used to provide power to the business's buildings and infrastructure and don't use large quantities of water for cooling.

Power-Generation Sources in Salt Lake County. Within the county, power is generated through hydroelectric facilities and site specific sources. About 5.4 megawatts of hydroelectric power are generated by Murray City in upper Little Cottonwood Canyon and by PacifiCorp at the Stairs and Granite facilities in upper Big Cottonwood Canyon (UGS 2015). There are many site specific infrastructure improvements that businesses and residents have implemented to generate power to assist with the demand for energy for a specific site or residence, below are a few examples of site improvements that generate power, or reduce the overall demand for power:

- 17% (about 1.65 megawatts) of the power required by the Salt Palace Convention Center is provided by roof top solar panels, while the Utah National Guard has implemented solar energy to generate about 23% of the power required at Camp Williams and IKEA creates 1-megawatt using solar.
- Geothermal energy is used for heating and cooling demands at the Millcreek Community Center and the Magna Senior Center
- Salt Lake City has created a solar energy farm and roof top solar panels to generate renewable energy and implement energy efficiency projects in support of an goal to transform all City facilities into “net zero” energy users.
- Rio Tinto Kennecott is implementing energy generation improvements including: micro-wind turbines (wind spires), solar panels, smelter facility cogeneration, and combined heat and power system that generate power from thermal resources at the refinery.

Opportunities

Managing water use to reduce energy demands and managing energy use to reduce water demands provide opportunities to extend limited water resources and provide for functioning ecological systems and a robust economy. As discussed above, some Salt Lake County businesses and municipalities are taking measures to reduce energy demands and the water needed to supply energy demands. Rocky Mountain Power also encourages and incentivizes its residential and commercial customers to conserve energy through its Wattsmart program. Consumers can also learn about ways to understand and lessen their energy use using online tools such as the U.S. Department of Energy’s energy.gov website (energy.gov/energysaver/save-electricity-and-fuel) and the Pacific Institute’s water-energy WECalc tool (www.wecalc.org).

Although resource managers recognize the need to optimize energy and water processes, the management of the water and energy systems is fragmented. On a local scale, day-to-day management of water resources and energy systems provides opportunities for discussion and to integrate water and energy decision-making. Table 3-15 lists opportunities for addressing water-energy demands on local water resources. Although this is not a comprehensive list, it can initiate discussions toward an integrated approach to policy development and management decisions.

The residents of Salt Lake County rely on energy and water resources that are imported, such that the geographic effect of the increased energy and water demands will extend throughout Utah. The water-energy nexus includes issues related to water resources and infrastructure, sustainable energy sources, and both water- and energy-efficient measures and systems.

Table 3-15. Water and Energy Opportunities

Opportunity	Benefit
Site Management Practices	
Green infrastructure	Reduction of stormwater and the discharge of pollutants from developed sites
Low-impact design	Minimization of infrastructure to support land uses while maximizing open and green spaces
Water Management Practices	
Low-water-use technologies	Drinking water conservation; reduction of wastewater requiring treatment
Increase water reuse and secondary water use	Reduction of demand for drinking water supply and treatment
Watershed habitat and stream management	Increase surface water quality; aquatic and terrestrial habitat and social benefits
Watershed and instream erosion-protection strategies	Stream bank stability; reduction of sediment transport; flood conveyance
Agricultural crop management	Reduction of water required for irrigation; minimization of sediment transported downstream
Smart meters for drinking water, irrigation, and wastewater systems	Accurate accounting and pricing for use of water; increased social awareness of water use
Residential-use water conservation	Reduced demands
Energy Management Practices	
Watershed protection	Reduced levels of drinking water treatment
Low-energy-use technologies	Reduced demands
Use of micro-hydroelectric production to offset energy demands	Reduced energy demands due to local production
Efficient use of waste heat (co-generation, biogas)	Reduced energy demands due increased efficiencies
Energy optimization by municipal drinking water and wastewater treatment utilities	Reduced energy demands due to increased efficiencies
Residential-use energy conservation	Reduced demands
Education	
Introduce information about the water and energy relationship	Understanding of the resource relationship
Support existing and establish new incentive programs that encourage energy conservation	Reduced water and energy demands

Sources: U.S. Department of Energy 2014; EPA 2015

Opportunities for reducing existing and future water and energy demands can only be accomplished through coordinated and integrated policy, structural efficiencies, and management programs. These opportunities could include municipally led green infrastructure and low-impact designs along with ecosystem management, watershed protection, and restoration investments as methods to minimize treatment costs, provide flood control, and maximize recreational opportunities to the residents of the county.

3.9 References

General Watershed, Population, and Land Use References

[GOMB] Governor's Office of Management and Budget

2012 2012 Baseline City Population Projections, 2010–2060.

[NRCS] U.S. Natural Resources Conservation Service

1986 Urban Hydrology for Small Watersheds, Technical Release 55. June.

[SLCO] Salt Lake County

2003 2002 Southwest Canal and Creek Study. Prepared by Bowen, Collins & Associates, Inc for Salt Lake County Engineering Division. April.

2007 A Study of Attitudes about the Salt Lake County Watershed. Conducted by Dan Jones & Associates for Stantec Consulting and Salt Lake County. April.

2010 Watershed Public Opinion Survey Report of Findings. Conducted by OpinionWorks for Salt Lake County. July.

2015 Watershed Public Opinion Survey Report of Findings. Conducted by OpinionWorks for Salt Lake County. January.

[UEC] Utah Economic Council

2015 Economic Report to the Governor.

[WFRC] Wasatch Front Regional Council

2015 Existing and future land use GIS layers.

Environmental Justice References

[USEPA] U.S. Environmental Protection Agency

2016 Environmental Justice. <http://www3.epa.gov/environmentaljustice/>. Accessed January 11

Water Quality References

Oleson, Diane

- 2013 Macroinvertebrates as Indicators of Water Quality. January 14. Penn State Extension, York County, PA.

[SLCO] Salt Lake County

- 2009 Salt Lake Countywide Water Quality Stewardship Plan.
- 2010 Stream Function Index. Addendum to 2009 Salt Lake Countywide Water Quality Stewardship Plan. April.
- 2013 Sampling and Analysis Plan for Salt Lake County. Watershed Planning and Restoration Program. May.
- 2015 Salt Lake County Municipalities and Township Boundaries. slco.org/pwpds/pdf/townships2.pdf. Accessed August 4, 2015.

State of Utah

- 2015a Utah Administrative Code, Rule R317-2-6, Use Designations. www.rules.utah.gov/publicat/code/r317/r317-002.htm#T8. Effective July 1, 2015. Accessed July 24, 2015.
- 2015b Utah Administrative Code, Rule R317-2-12, Category 1 and Category 2 Waters. www.rules.utah.gov/publicat/code/r317/r317-002.htm#T14. Effective July 1, 2015. Accessed July 27, 2015.

[UDWQ] Utah Division of Water Quality

- 2014 2014 draft Integrated Report. October. www.deq.utah.gov/ProgramsServices/programs/water/wqmanagement/assessment/currentIROct.htm. Accessed June 9, 2015.

Habitat References

Rosgen, D.L., and H.L. Silvey

- 1996 Applied River Morphology. Second Edition. Wildland Hydrology Books, Fort Collins, Co.

[SLCO] Salt Lake County

- 2010 Stream Function Index. Addendum to 2009 Salt Lake Countywide Water Quality Stewardship Plan. April.

Climate Change References

- Bardsley, Tim, Andrew Wood, Mike Hobbins, Tracie Kirkham, Laura Briefer, Jeff Niermeyer, and Steven Burian
- 2013 Planning for an Uncertain Future: Climate Change Sensitivity Assessment toward Adaptation Planning for Public Water Supply. *Earth Interactions* Volume 17, Issue 23 (October 2013), 1–26.
- [IPCC] Intergovernmental Panel on Climate Change
- 2013 Summary for Policymakers. www.climatechange2013.org/images/report/WG1AR5_SPM_FINAL.pdf.
- Lambson, Cort
- 2015 Personal communication between Cort Lambson, Central Utah Water Conservancy District, and Steven Thurin, HDR regarding model results, September 16.
- [LLNL] Lawrence Livermore National Laboratory
- 2015 Consolidated Model Intercomparison Project. cmip-pcmdi.llnl.gov/cmip5. Accessed August 14.
- U.S. Forest Service
- 2015 Intermountain Adaptation Partners. adaptationpartners.org/iap. Accessed August 14.
- [USGCRP] U.S. Global Change Research Program
- 2014 Our Changing Planet [U.S. Global Change Research Program website]. www.globalchange.gov.

Water and Energy References

- [EIA] U.S. Energy Information Administration
- 2015 Monthly Energy Review for October 2015. www.eia.gov/totalenergy/data/annual. Accessed October 29, 2015.
- [EPA] U.S. Environmental Protection Agency
- 2015 Water and Energy Efficiency. water.epa.gov/infrastructure/sustain/waterefficiency.cfm. Accessed September 28, 2015.
- [GOED] Governor’s Office of Energy Development
- 2015 Energy overview. <http://energy.utah.gov/resource-areas/energy-information/>. Accessed September 28, 2015.
- IEEE
- 2008 How Much Water Does It Take To Make Electricity? spectrum.ieee.org/energy/environment/how-much-water-does-it-take-to-make-electricity#. Accessed October 1, 2015.

[SEIA] Solar Energy Industries Association

- 2015 Information about solar installations in Utah. www.seia.org/state-solar-policy/utah-solar. Accessed October 1, 2015.

[SUNY] State University of New York, College of Environmental Science and Forestry

- 2015 Fluvial Geomorphology Glossary. www.fgmorph.com/fg_3_14.php. Accessed October 1, 2015.

Torcellini, P., N. Long, and R. Judkoff

- 2003 Consumptive Water Use for U.S. Power Production. Prepared for the National Renewable Energy Laboratory. TP-550-33905.

U.S. Department of Energy

- 2003 National Renewable Energy Laboratory. Consumptive Water Use for U.S. Power Production. NREL/TP-550-33905. December.
- 2014 The Water-Energy Nexus: Challenges and Opportunities.
- 2015 Estimating appliance and home electronic energy use. Interactive tool available online. energy.gov/energysaver/estimating-appliance-and-home-electronic-energy-use. Accessed October 28, 2015.

[UCS] Union of Concerned Scientists

- 2015 Environmental Impacts of Solar Power. www.ucsusa.org/clean_energy/our-energy-choices/renewable-energy/environmental-impacts-solar-power.html. Accessed October 1, 2015.

[UGS] Utah Geological Survey

- 2015 Hydroelectric Power Plants in Utah. files.geology.utah.gov/emp/energydata/statistics/electricity5.0/pdf/T5.6.pdf. Updated August 11, 2015. Accessed September 17, 2015.

[USGS] U.S. Geological Survey

- 2010 Estimated Use of Water in the United States, County-Level Data for 2000. water.usgs.gov/watuse/data/2000. Accessed October 29, 2015.
- 2014a Thermoelectric Power Water Use. water.usgs.gov/watuse/wupt.html. Accessed October 1, 2015.
- 2014b Estimated Use of Water in the United States, County-Level Data for 2010. water.usgs.gov/watuse/data/2010. Accessed October 1, 2015.
- 2014c Hydroelectric power water use. water.usgs.gov/edu/wuhy.html. Accessed October 1, 2015.

This page is intentionally blank.

4.0 WATERSHED PLANNING ELEMENTS

In order to achieve the strategic targets outlined in the 2009 Plan (see Section 1.2), nine watershed planning elements were evaluated to help identify both countywide and sub-watershed specific project recommendations and implementation activities: Economics, Wastewater, Stormwater, Nonpoint Source Pollution, Water Supply, Instream Flows, Habitat, Utah Lake, and Headwaters Protection.

This 2015 Plan focuses on updating relevant planning elements, and incorporates the 2009 Plan by reference since much of the evaluation and analysis in the 2009 Plan remains unchanged.

This chapter updates the following planning elements:

- Stormwater
- Water supply
- Municipal and industrial wastewater discharges (point source pollution)
- Nonpoint source pollution

This update also includes two pilot studies which can be used as test approaches for planning related to water quality and watershed health improvements:

- Debris basin retrofit study for Spencer's Pond
- Instream flow study in Little Cottonwood Creek

4.1 Stormwater Discharges

Stormwater runoff from developed and undeveloped areas of Salt Lake County carries a variety of pollutants to receiving waters, including sediment, nutrients, heavy metals, hydrocarbons, and organic materials. This section provides updated information regarding federal, state, and local stormwater regulatory programs, industrial stormwater discharge permits, and municipal discharge pollutant characterizations. This section updates the stormwater information in the 2009 Plan.

2009 Plan Summary

Section 4.3 of the 2009 Plan describes the existing regulatory programs aimed at controlling stormwater discharges from municipalities and industries to receiving waters and subsequent enforcement actions. It also summarizes results from the 1974 hydrologic basin study, 1978 area-wide water quality management plan, and 1983 Nationwide Urban Runoff Program. Finally, it presents stormwater permitting requirements and analytical results that represent average concentrations of pollutants in stormwater runoff as measured by the County at five sampling stations.

Regulatory Framework

Stormwater discharges are regulated federal, state, and local agencies. In Salt Lake County, applicable regulations include:

- Section 402 of the Clean Water Act, which is administered by the State of Utah as the Utah Pollutant Discharge Elimination System (UPDES);
- Title R317-8 of the Utah Clean Water Act, which is administered by the Utah Division of Water Quality (UDWQ);
- Health Regulation 13, Wastewater Disposal Regulation, which is enforced by the Salt Lake County Health Department (SLCOHD); and
- Local municipal ordinances (including Salt Lake County Ordinance 17.22 Stormwater Quality).

UDWQ issues UPDES permits that regulate stormwater discharges to receiving waters from industrial, municipal, and construction activities. UPDES stormwater permits can be general (apply to a general activity or area) or individual (apply to a more specific activity or entity).

The State regulates construction-related stormwater discharges using a general permit, UPDES Permit No. UTRC00000. Owners of projects with construction activities that disturb 1 acre or more of land, or are part of a common plan of development, are required to submit a notice of intent (NOI) to comply with the general permit and to prepare a Stormwater Pollution Prevention Plan. The State uses individual and general UPDES permits to authorize stormwater discharges from municipal separate storm sewer systems (MS4).

Stormwater permits are renewed on a 5-year basis for consistency with federal and state regulatory requirements. Stormwater discharge permits include conditions to meet TMDL requirements, if stormwater is discharged into impaired waters and if TMDL implementation plans include allocations.

Industrial Stormwater Discharges

Operators of facilities that fall under certain Standard Industrial Classification (SIC) codes are required to submit an NOI to use the State's general multisector permit or to submit an individual permit application to UDWQ. In both cases, the applicant must prepare a Stormwater Pollution Prevention Plan. For the State's general multisector permit, there are 30 defined industrial sectors that are covered under five general permits. The specific general permit that applies is based on each facility's SIC code(s). Typical industrial facilities include, but are not limited to, recycling facilities, landfills, transportation facilities, steam electric plants, wastewater treatment works, and manufacturing facilities.

Figure 4-1 shows the number of active industrial stormwater discharge permits (not including construction) regulated by UDWQ in Salt Lake County. As can be seen on the map, the areas with higher concentrations of discharge facilities has implications for more water quality effects in the lower Jordan River and, ultimately, the Great Salt Lake.

obtain NPDES permit coverage for their stormwater discharges. Generally, Phase II MS4s are covered by general permits.

Within the county, there are three MS4 discharge permits designated as Phase I. These permits are issued to Salt Lake City, Salt Lake County (for unincorporated areas and facilities owned and operated by Salt Lake County), and the Utah Department of Transportation. There are 16 Phase II permittees, which include all municipalities in the county except the Town of Alta. Universities and other publicly owned systems are required to apply for MS4 permits. These types of uses are typically included in as Phase II permits.

Salt Lake County has been sampling stormwater discharges since 1992 and has collected data from over 40 storm events. This data collection has been conducted in accordance with the County's MS4 permit. Every permit term (which is 5 years long), the County is required to prepare a technical report summarizing the analytical sampling results for that period. The most recent report, the 2014 Stormwater Quality Technical Report, summarizes the stormwater discharge sampling data, analyzes the results for trends, and presents estimates of annual pollutant loads (SLCO 2014). For this integrated watershed plan, the analysis focuses on the following six key constituents:

- Total suspended solids (TSS)
- Total phosphorus (TP)
- 5-day biochemical oxygen demand (BOD₅)
- Total copper (TCu)
- Total lead (TPb)
- Total zinc (TZn)

The County chose these key constituents because they are *indicator constituents*. This means that they represent the general nature of stormwater quality, are the most prevalent, and are good indicators of general conditions countywide. The County's stormwater sampling program conducts stormwater discharge sampling at the drainage system outfalls to receiving waters from different types of land uses. The County has historically collected samples from five stations that characterize discharges from *unincorporated* developed areas that are dominated by commercial, industrial, residential, or mixed land uses. Because of recent municipal incorporations and new permit conditions, the County currently collects samples from four sampling stations. The County also collects data at a transportation land-use outfall under an agreement with the Utah Department of Transportation.

The site discharge data are used to calculate an event mean concentration (EMC) for each pollutant for the dominant land use(s). This EMC represents the average pollutant concentration found in stormwater discharges sampled and can be used to predict annual pollutant loads.

Table 4-1 shows the EMC analysis conducted by the County. In general, the results show that:

- Runoff from commercial land-use areas had the lowest EMCs for all five key constituents
- Runoff from the transportation land-use areas had the highest EMCs for TSS, TCu, TPb, and TZn
- Residential land-use areas discharged the highest TP EMC and the lowest BOD₅ and EMC (SLCO 2014)

The specific outfall data can be averaged to calculate the pollutant EMC for stormwater discharges from the land uses measured. Table 4-1 shows site-specific EMCs for the six constituents and average EMCs from all land uses for each constituent.

Table 4-1. Salt Lake County Stormwater Discharge Event Mean Concentrations (2009 - 2013)

Receiving Water/ Station Number	Dominant Land Use	2009 - 2013 Event Mean Concentration (EMC) (milligrams/liter)					
		Total Suspend Solids	Total Phosphorous	Biochemical Oxygen Demand	Total Copper	Total Lead	Total Zinc
Decker Lake 02/01	Commercial	82.1	0.30	13.0	0.037	0.026	0.097
Decker Lake 05	Industrial	150.1	0.41	16.8	0.038	0.029	0.200
Jordan River 04/03	Transportation	187.6	0.38	11.0	0.058	0.052	0.315
Little Cottonwood Creek 06 and Mill Creek 07	Residential	133.3	0.55	5.9	0.044	0.032	0.155
Event Mean Concentration	All	137	0.53	14.7	0.043	0.039	0.160

Source: SLCO 2014

To understand the strength of the relationships between the variables measured, the County completed a linear regression analysis for each of the pollutants by land use. This analysis was used to identify whether any trends were present and, if so, the strength of those trends. The analysis showed that industrial and transportation land-use pollutant concentrations are generally trending downward or flat (SLCO 2014) but that the pollutant concentration data have a large amount of variability. This variability affects the strength of the trends, and results indicate that the variables are not strongly correlated.

Finally, the County used the EMC data to estimate pollutant load rates for the key constituents to receiving waters from developed, unincorporated areas. The results, which are shown in Table 4-2, represent the 2013 estimate of annual constituent load per acre of land draining to receiving waters. Over the last 5 years, all estimated pollutant load rates have remained relatively similar, except for TP, which has decreased from a high in 2010 of 0.54 pounds per acre per year to the 2013 estimate of 0.48 pounds per acre per year (SLCO 2014).

These rates, applied to projected development areas, could be used to predict future effects on receiving waters and provide the basis of water quality improvement planning.

Table 4-2. Estimated Pollutant Load Rates in Unincorporated Salt Lake County

Constituent	2013 Estimated Annual Loading Rate ¹ (pounds/acre/year)
Total suspended solids	118.000
Total phosphorus	0.480
Biochemical oxygen demand	12.000
Total copper	0.037
Total lead	0.034
Total zinc	0.140

Source: SLCO 2014

¹ As estimated from outfalls draining unincorporated areas

Summary

Discharges from stormwater to receiving waters are permitted by federal, state, and local regulating agencies through the implementation of best management practices. These best management practices are implemented to the maximum extent practicable to reduce the discharge of pollutants into receiving waters. These regulatory permits are renewed on a 5-year basis to include new regulatory requirements, reflect new technology, and further define permit conditions and implementation expectations. Salt Lake County's MS4 Permit (titled *Jordan Valley Municipalities (MS4) Permit No. UTS000001*) was renewed in September 2013. For more information about UPDES stormwater permits, go to <http://www.deq.utah.gov/Permits/water/updes/stormwater.htm>. Stormwater discharge permits include conditions that address concurrent TMDL requirements should stormwater be discharged to impaired waterbodies and have TMDLs.

Within the county, Salt Lake City, Salt Lake County, and the Utah Department of Transportation sample and analyze stormwater discharges to quantify the amount of pollutants conveyed to receiving waters. These pollutant estimates can provide the scientific and engineering basis to implement management strategies and design and construct water quality improvements to reduce the discharge of pollutants to receiving waters.

4.2 Water Supply

This section reviews the regulatory framework for water supply in Salt Lake County, water supply systems, and water supply sources. It focuses primarily on potable (drinking) water supply and suppliers. This section updates the water supply information in the 2009 Plan.

2009 Plan Summary

Section 4.5 of the 2009 Plan describes the entities that supply water to residents and businesses in the county and the plans to meet demands in the future. The 2009 Plan reviewed existing water supply systems and sources, reviewed groundwater and drinking water quality standards,

reviewed master plans of principal water providers, described existing water treatment facilities, and identified the effects of water supply strategies on water quality in Salt Lake County.

Specifically, the water supply strategies discussed in the 2009 Plan included: development of local groundwater, collection and treatment of additional Wasatch Mountain stream water, importing water from outside Salt Lake County, reuse of wastewater for landscape irrigation, and conservation. The 2009 Plan called for the importance of coordination between water providers, wastewater treatment facilities, and watershed managers, given that any application of these strategies could affect the hydrology of waters in Salt Lake County. Section 4.5.9 of the 2009 Plan recommended that the County participate in water supply in the following ways: 1) facilitate discussions between water supply, wastewater, and stormwater professionals to assure that water resources are viewed collectively in Salt Lake County; 2) support water reuse efforts; and 3) support water conservation efforts.

Regulatory Framework

Water suppliers develop, treat, convey, and provide drinking and irrigation water to customers in the county. Protection of surface water and groundwater sources relies on watershed management regulations and policies that are primarily implemented by the SLCOHD Drinking Water Program and local groundwater-protection ordinances. Salt Lake City Department of Public Utilities regulates several canyons in the Wasatch Front as drinking water source protection areas. Dogs, horses, and swimming are strictly forbidden in these areas. The protected canyons include: City Creek (upper canyon), Parley's Creek (upper canyon), Big Cottonwood, Little Cottonwood, and Bells Canyons. In addition, the state Drinking Water Program surveys water systems by conducting site visits and collects administrative data to ensure that drinking water systems maintain safe drinking water according to the federal Safe Drinking Water Act.

The Utah Division of Drinking Water (UDDW) oversees drinking water at a more general level. UDDW provides assistance for drinking water system establishment and operation, reviews drinking water plans, and provides standard reports for each water system in Utah through its website.

Water supply is regulated primarily through the Utah Division of Water Rights (UDWRi), which regulates the appropriation and distribution of water in Utah. UDWRi is an office of public record for information about water rights, excepting information related to water right ownership, which is maintained by county recorder offices for the county(ies) in which the water is diverted.

The Utah Division of Water Resources (UDWRe) has developed a state conservation goal to reduce per-capita water use by at least 25% by 2025. UDWRe estimates that, from 2000 through 2010, per-capita water use was reduced by 18%. Based on 2010 data, statewide per-capita use is about 95 gallons for indoor use (about 40%) and about 145 gallons for outdoor use (about 60%) (UDWRe 2015). UDWRe is promoting education, technology, water efficiency, restructuring water rates based on a tiered system, and leak detection as means and methods for water suppliers to meet this goal.

Water Supply Systems

Potable (drinking) water is provided by various municipal water systems, private water companies, and two large water districts. This section describes water supply for municipal and private water suppliers.

There are 34 community water systems in Salt Lake County that serve homes and businesses year-round. An additional 40 non-community water systems serve locations such as schools, campgrounds, rest stops, and gas stations throughout Salt Lake County (2009 Plan). Table 4-3 lists the 34 community water systems, the population served, the total number of connections reported, and the primary source of water in 2014. Compared to information in the 2009 Plan, the 2014 data show an additional population served of 82,195 and 26,430 additional connections. The increases are about 8% and 10%, respectively, over the information in the 2009 Plan.

Table 4-3. Public Water Suppliers (2014)

Water System	Population Served ³	Number of Connections	Primary Water Source
Alta Town	400	84	Groundwater
Bluffdale	8,200	2,493	Surface water purchased
Boundary Spring Water Company	150	51	Groundwater
Copperton Improvement District	990	325	Groundwater
Cottonwood Coves, Inc.	250	NA	Surface water purchased
Dansie Water Company	50	0	Groundwater
Draper City	15,000	3,857	Surface water purchased
Emigration Improvement District	600	278	Groundwater
Granger-Hunter Improvement District	106,000	27,030	Surface water purchased
Herriman City Municipal Water Department	22,500	6,964	Surface water purchased
Hi-Country Estates #2	300	130	Surface water purchased
Hi-Country Estates #1	329	89	Surface water purchased
Holliday Water Company	15,000	3,975	Surface water purchased
Jordan Valley Water Conservancy District ¹	82,500	8,640	Surface Water
Kearns Improvement District	49,000	13,640	Surface water purchased
Magna Water Improvement District	31,100	8,316	Surface water purchased
Metro-Water District of Salt Lake & Sandy ²	See note 2	2	Surface Water
Midvale City Water Department	11,900	7,065	Surface water purchased
Mountain Valley Water Company	65	NA	Groundwater
Murray City	36,000	10,046	Surface water purchased
Riverton City Water System	38,753	9,389	Surface water purchased
Salt Lake City Corporation	318,506	90,435	Surface Water
Sandy City	99,750	27,260	Surface water purchased
Silver Fork Pipeline Corporation	300	260	Groundwater
Silver Lake Company	320	108	Groundwater
SL County Service Area No 3 - Snowbird	3,200	164	Groundwater
South Jordan City Municipal Water	57,067	18,984	Surface water purchased

Table 4-3. Public Water Suppliers (2014)

Water System	Population Served ³	Number of Connections	Primary Water Source
South Salt Lake City Culinary Water System	18,000	0	Surface water purchased
Spring Glen Water Company	50	NA	Groundwater
Taylorsville-Bennion Improvement District	67,000	16,985	Surface water purchased
Waterpro Inc. (Draper Irrigation District)	28,000	7,674	Surface Water
Webb Well Water Users	90	49	Groundwater
West Jordan City Utilities	108,000	22,524	Surface water purchased
White City Water Improvement District	15,800	4,180	Groundwater

Source: DWRI 2015

¹ JWCD is also a wholesaler. The number shown in this table is JWCD direct customers only (JWCD 2015a).

² MWDSLS is strictly a wholesale provider. Although it does provide potable water to a significant population (427,000), these residents are accounted for in the Salt Lake City Corporation and Sandy City water systems.

³ Estimated

As shown above in Table 4-3, the water suppliers with the greatest number of connections and that service the most individuals are Granger-Hunter Improvement District, Salt Lake City Corporation, Sandy City, and West Jordan City. The service populations reported in Table 4-3 are an estimate, and the data might not be consistent with Census data, in part because of the way that individual water suppliers account for the residents and connections they serve. For example, two entities might report service to overlapping populations. Additionally, various lists of water systems are available, and these lists can be quite different because of their reporting methods.

Sources for drinking water in Salt Lake County include: groundwater and springs; Wasatch Mountains streams (City Creek, Parley's Creek, Big Cottonwood Creek, Little Cottonwood Creek, Bells Canyon, and several smaller streams); and import water from outside the county boundaries. For this 2015 Plan, the term *import water* includes water that would naturally flow into the county but is diverted upstream of the county and is conveyed through pipelines and canals into the county. For example, Provo River water could reach Salt Lake County through Utah Lake and the Jordan River but could also be diverted upstream and conveyed by pipeline into the county.

The three principal water providers that service a majority of the population in the county are the Salt Lake City Corporation Department of Public Utilities (SLCPU), the Metropolitan Water District of Salt Lake and Sandy (MWDSLS), and the Jordan Valley Water Conservancy District (JWCD). MWDSLS is primarily a wholesaler, and JWCD provides wholesale and retail water. SLCPU does not wholesale water to other suppliers.

Because of the nature of water supply sources, public and non-community suppliers, inter-local supply agreements, and the varying demand year to year, it is difficult to estimate an annual amount of water provided to customers in Salt Lake County. However, distribution data based on water supply source can indicate the proportions of the types of water used by customers in the county. Table 4-4 provides an example based on JWCD's customer use by summarizing the major sources and amounts of water used by its customers in 2014.

Table 4-4. Water Sources and Volume Used by JWCD Customers (2014)

Source	AF/Year
Groundwater	69,400
Surface water	126,700
Secondary water	23,700
Import water	60,900
Total	280,700

This information includes water supplied by JWCD, by its 22 member agencies (customers) directly, or by other sources.
AF = acre-feet

Depending on the source and ultimate use of the water, suppliers might need to treat water before delivering it to the customer. Table 4-5 summarizes the existing water treatment facilities and plant design capacities. Since the 2009 Plan was issued, MWDSLS and JWCD have constructed new water and groundwater treatment facilities.

Table 4-5. Existing Water Treatment Plants and Capacities

Treatment Plant (Owner)	Design Capacity (AF/year)
Big Cottonwood Canyon Water Treatment Plant (Salt Lake City) ¹	51,100
Bingham Canyon Water Treatment Plant (JWCD and Rio Tinto) ³	4,000
Salt Lake City Water Treatment Plant (Salt Lake City) ^{1,4}	17,500
Bells Canyon Creek/Draper Irrigation Co. (WaterPro) ²	9,000
Little Cottonwood Canyon Water Treatment Plant (MWDSLS) ²	192,400
Jordan Valley Water Treatment Plant (JWCD) ³	242,200
Parleys Canyon Treatment Plant (Salt Lake City) ¹	47,100
Point of the Mountain Water Treatment Plant (MWDSLS) ²	94,200
Southeast Regional Water Treatment Plant (JWCD) ³	27,000
Southwest Groundwater Treatment Plant (JWCD) ³	9,500

¹ Source: SLCO 2009

³Source: JWCD 2015b

² Source: MWDSLS 2014

⁴located in upper City Creek canyon

Existing and Future Water Supply Sources

About 65% of the water delivered to customers in Salt Lake County is provided by SLCPU, MWDSLS, and JWCD. The remainder of this section summarizes the future planning efforts as reported by the three water suppliers.

Salt Lake City

Salt Lake City provides water to customers via SLCPU within and outside its municipal jurisdiction. Major sources of water include surface water, groundwater, and water provided by MWDSLS. Table 4-5 above identifies the three water treatment plants that are owned and operated by Salt Lake City.

Salt Lake City conducted a planning study for future water supply, *Major Conveyance Study*, in 2007, and information from this study was included in the 2009 Plan. Salt Lake City has a 2011 updated Water Supply and Demand Evaluation completed for both surface and groundwater for extension of several water rights in its Service Area.

MWDSLS's 40-Year Water Supply Plan (MWDSLS 2014) reported Salt Lake City's existing and future sources of water for both dry and average precipitation years, based on service population predictions. Table 4-6 shows existing and future water supply sources for the City for an average precipitation year. Table 4-6 does not include the additional water supplied by MWDSLS

Table 4-6. Salt Lake City Existing and Future Sources

Source Category	Average Precipitation Year Supply (AF)	
	Existing	Future
Surface water	42,300	46,300
Groundwater wells and springs	11,900	19,900
Water reuse	0	5,000
Total	54,200	71,200

Source: MWDSLS 2014

To meet the future demands, Salt Lake City's plans include:

- **New Groundwater Source Development.** The City plans to develop new groundwater wells throughout its system. The City estimates that the development of the first phase of city groundwater rights could provide an additional 12,000 acre-feet (AF) in dry years to replace lower surface water sources. In average precipitation years, the groundwater source would provide 3,000 AF. In later phases of groundwater development, Salt Lake City has about 17,000 AF of groundwater rights that could be developed to provide future dry-year supplies and about 5,000 AF for future average precipitation years.
- **New Surface Water Development.** The City is studying the development of additional surface water sources. This could include developing a water treatment plant for water from Millcreek Canyon. The City's goal is to develop at least an additional 3,300 AF for use during dry years. For average precipitation years, the new surface water sources would supply about 4,000 AF.
- **Wastewater Reuse.** The City is studying potential wastewater reuse opportunities. These opportunities include irrigation of two large golf courses and a park area near one of the

City's wastewater treatment plants. The City estimates that reuse of the wastewater treatment plant water could produce about 5,000 AF annually for irrigation purposes.

- **Secondary Water.** The City is currently conducting a study to identify city property where secondary (irrigation) water could be used.

Salt Lake City conducted a Hydrologic Modeling Study in 2013 to evaluate the effects of climate change on water supply sources, focusing on surface water source quantities resulting from predictions of drought conditions (see Section 3.7, Climate Change).

Metropolitan Water District of Salt Lake & Sandy

MWDSLS supplies water to Salt Lake City and Sandy City and periodically provides water to other suppliers as a wholesale provider. Major sources of water include surface water from Little Cottonwood Creek and Bells Canyon Creek and water imported through the Provo River Project, Central Utah Project, and Ontario Drain Tunnel.

MWDSLS owns and operates two water treatment plants, Little Cottonwood Water Treatment Plant and Point of the Mountain Water Treatment Plant (see Table 4-5). In addition, MWDSLS owns 2/7ths of the Jordan Valley Water Treatment Plant. The Little Cottonwood Water Treatment Plant treats water collected from the upper Little Cottonwood Creek watershed and imported water that is conveyed from the Provo River System through the Salt Lake Aqueduct. The Point of the Mountain Water Treatment Plant treats imported water that is conveyed to Salt Lake County via the Provo River Aqueduct or Jordan Aqueduct and then via the raw water section of the Point of the Mountain Aqueduct.

In 2014 MWDSLS conducted a study of water supply demands through 2055 (the future year for the study). Based on the results of the study, MWDSLS determined that:

- There is no current need to increase areas serviced by MWDSLS.
- Service-area population is projected to increase from 435,107 in 2015 to 602,125 in 2055.
- Service-area population demand is projected to increase by over 76,000 AF without conservation efforts; with conservation efforts to meet the State's conservation goal, population demand is projected to increase by 32,000 AF (MWDSLS 2014).

Figure 4-2 shows the 40-year water supply plan for the MWDSLS service area based on historic use and with the state conservation goal applied. The planning graph indicates the projected demand with and without the state conservation goal applied and when additional water sources will be added to the system. Additionally, MWDSLS has developed, for planning purposes, a recommended minimum production line, shown in red.

Figure 4-2. MWDSLS Future Water Supply Plan

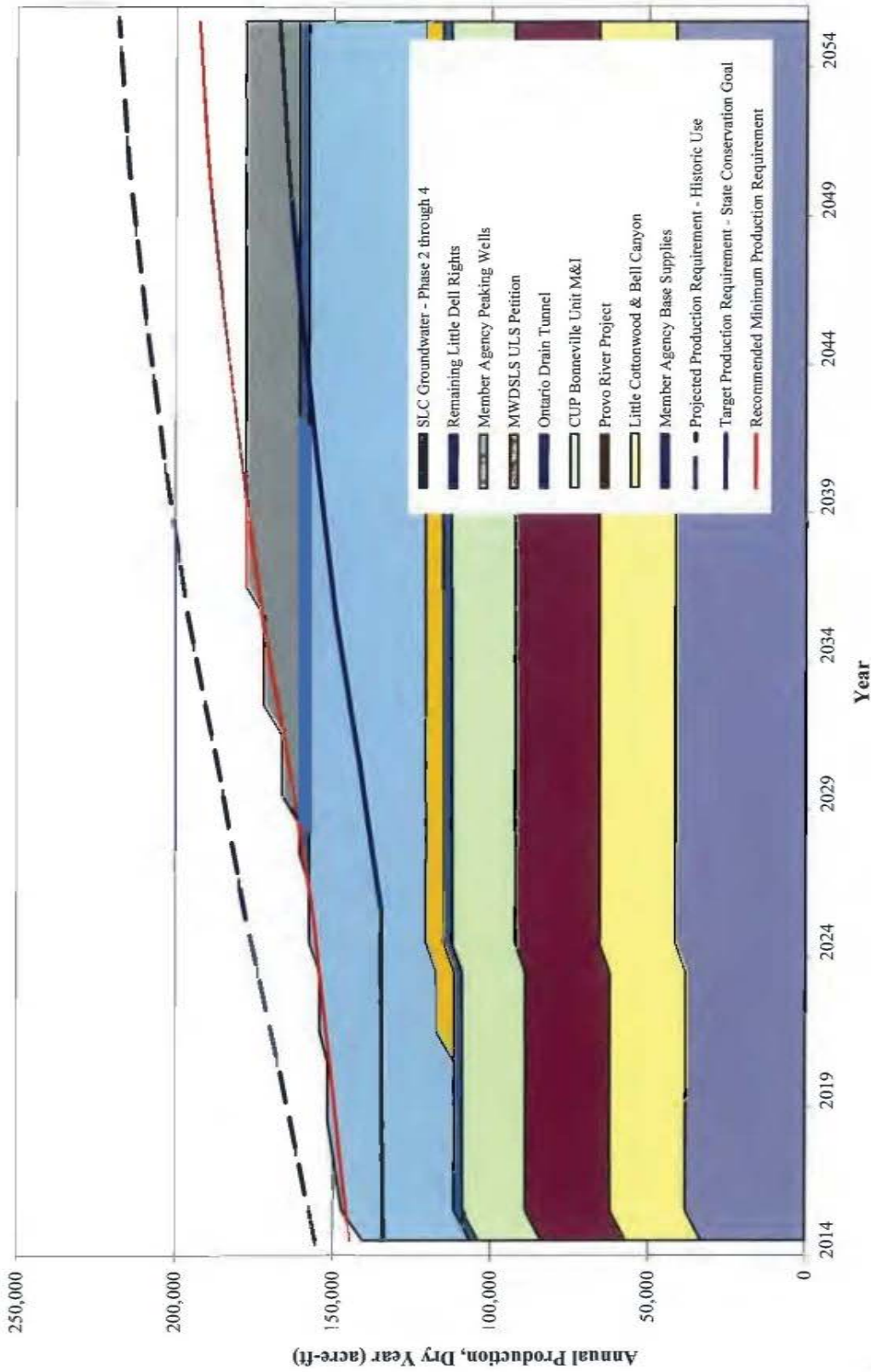

Source: MWDSLS 2014

The MWDSLS 2014 study also identified existing and future sources of water for both dry and average precipitation years, based on the service population predictions. Table 4-7 below summarizes the surface water and import water sources required to meet existing and future demands under average precipitation conditions. These sources are required to provide water, in addition to the water supplied directly by member agencies (Salt Lake City and Sandy City) sources.

Table 4-7. MWDSLS Existing (2014) and Future (2055) Water Sources

Source Category	Average Precipitation Year Supply (AF)	
	Existing	Future
Surface water	36,800	46,400
Import water	85,000	90,600
Total	121,800	137,000

Source: MWDSLS 2014

MWDSLS is currently considering the following potential new sources of water:

- A new import water source of 5,600 AF that would be conveyed from the Central Utah Project through the Utah Lake System.
- New surface water through phased development of existing water rights in Little Dell Reservoir (in Parley's Canyon).

In addition, MWDSLS has identified concerns with regard to future water supply sources and future demands. The concerns include:

- Surface water sources could be reduced as a result of climate and precipitation pattern changes.
- Management of import water storage and conveyance facilities could affect the amount of import water provided.
- Demand could increase as a result of potential higher temperatures and more water than what has historically been used for irrigation.

Jordan Valley Water Conservancy District

The service boundaries for the JWCD encompass the central and western portions of the Salt Lake Valley. It wholesales water to member agencies and retails water directly to individual connections in a relatively small service area in and around Holladay. Major sources of water include import water and groundwater. JWCD imports more water to the valley than does any other water provider. JWCD also operates a groundwater treatment plant and two water treatment plants, which are identified in Table 4-8.

Since the 2009 Plan was issued, JWCD updated its supply plan to track the past 15-year demand and identify future water demands through 2060 (Figure 4-3 on page 125). The graph in Figure 4-3 identifies future demand for water provided by the JWCD service district for two

conditions: historic use as of 2000 and use with the State’s 25% conservation goal applied through 2060.

MWDSLS’s 40-Year Water Supply Plan (MWDSLS 2014) also reported JWCD existing and future sources of water for both dry and average precipitation years, based on the service population predictions. Table 4-8 summarizes the existing and future water sources for JWCD and its member agencies for an average precipitation year.

Table 4-8. JWCD Existing and Future Sources

Source	Average Precipitation Year Supply (AF)	
	Existing	Future
Import water	75,000	153,100
Groundwater	28,000	36,000
Total	103,000	189,100

Source: MWDSLS 2014

JWCD is currently planning future water supplies that would come from the development of new sources. These future supplies include:

- 11,680 AF of import water from the Central Water Project, which comes from groundwater produced near the Town of Vineyard, Utah County. This would be supplemented with Provo River surface water to be delivered in 2015; 16,400 AF of imported water from the Utah Lake System Project in 2027; and 50,000 AF of imported water from the Bear River Project (Phase 1 in 2040 and Phase 2 in 2050).
- 8,000 AF of brackish shallow groundwater, which is to be treated and delivered in 2034.

In addition, JWCD has identified concerns regarding future water supply sources and future demands. These concerns include:

- JWCD is currently providing funding for preliminary feasibility studies for potential projects that would reuse treated wastewater in secondary irrigation systems. Central Utah Project obligations for the Utah Lake System include the requirements to reuse 18,000 AF from the Bonneville Unit segment of the Central Utah Project by 2033.
- Significant water conservation efforts will be required to meet future demands.

Summary

To service projected population increases, Salt Lake County’s three major water suppliers—SLCDPU, MWDSLS, and JWCD—plan to develop future water resources within and outside the county, including new surface water supply and new groundwater sources. This section summarized the future planning efforts as reported by the three water suppliers.

Specifically, SLCPU, MWDSLS, and JWCD have plans for new water resource development projects, including:

- Projected increases of imported water to Salt Lake County of 86,000 AF total.
- Wastewater reuse of about 23,000 AF. Both JWCD and SLCPU have plans to support the development of reuse of wastewater to meet future irrigation demands.
- Additional surface water development by Salt Lake City and MWDSLS.

These new water-resource-development projects are supplemented by secondary water sources and implementation of the State's water-conservation goal. Water suppliers are also evaluating the potential decrease in surface water supplies resulting from climate change and the potential for changes in the annual precipitation patterns resulting in lower surface water stream flows.

As population continues to increase in Salt Lake County, water distributors and suppliers anticipate developing numerous strategies to meet future water supply demand. Some of these strategies include: development of local groundwater, collection and treatment of additional Wasatch Mountain stream water, importing water from outside Salt Lake County, reuse of wastewater for landscape irrigation, and conservation. Salt Lake County supports the implementation of water reuse and conservation efforts to address projected future demand.

Figure 4-3. JWCD Future Water Supply Plan

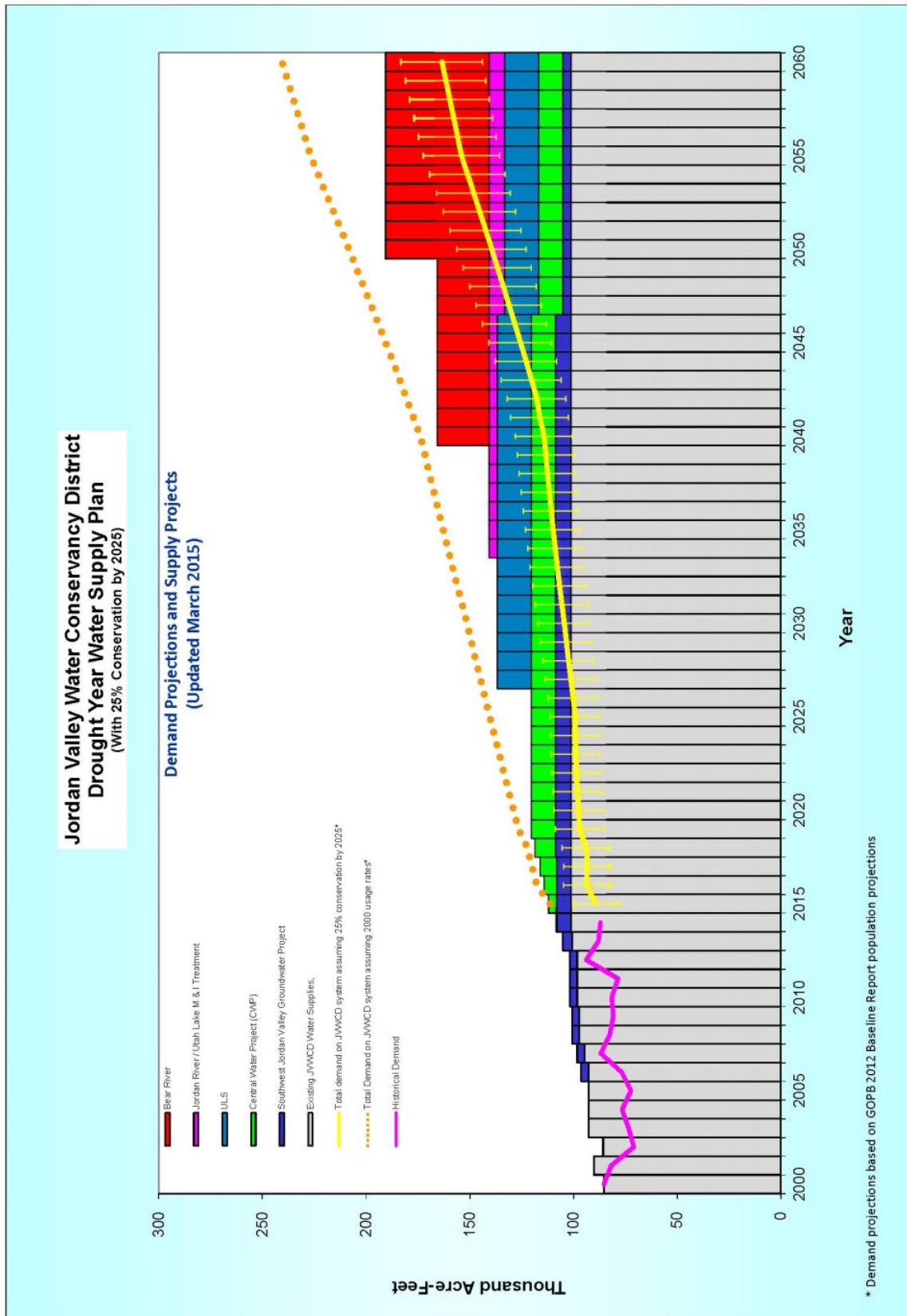

Source: JWCD, 2015a

4.3 Municipal & Industrial Wastewater Discharges

This section provides a description of existing municipal wastewater facilities, reviews current regulatory standards and trends, discusses implications to wastewater facilities with the implementation of TMDLs, and identifies new or expanded wastewater treatment facilities that are currently being planned.

2009 Plan Summary

The 2009 Plan included a detailed analysis of the four existing municipal wastewater treatment service areas and facilities. The analysis compared the facility capacities, flows, and effluent characteristics to those predicted by the 1978 Plan. The 2009 Plan also described trends and technologies relating to secondary and tertiary treatment and disinfection treatment processes, biosolids, and decentralized treatment systems. In addition, the 2009 Plan reviewed upcoming Utah rule changes related to on-site septic systems and upcoming studies to further define uses and standards for the Great Salt Lake.

The 2009 Plan also included details of South Valley Sewer District's proposed new wastewater treatment facility in Riverton. The *Jordan Basin Water Reclamation Facility* began operation in 2012. The 2009 Plan estimated future wastewater flow projections by service area and future facility loading predictions for TSS and BOD. This analysis was conducted spatially and included the predicted areas of growth at that time. The 2009 Plan also included an alternative analysis, which concluded that, collectively, the four existing facilities and one proposed facility would have the capacity to serve the future population projected for 2030; however, use of this capacity might be limited by conveyance. Area build-out and population projections beyond 2030 were not conducted. Future area-wide planning focusing on water quality, biosolids management, and area-build out were recommended.

Finally, the 2009 Plan included a process to update this plan in the event that new municipal treatment discharges were planned. The process for plan update and new discharge permitting requirements has not changed and remains current. For details, see Section 5.7, Plan Amendment Process (in this 2015 Plan), and Section 6.5, Procedural (in the 2009 Plan).

Existing Municipal Wastewater Treatment Facilities

Since the 2009 Plan was issued, there have been no expansions of service areas by the five water reclamation facilities that provide municipal wastewater treatment services in the county. These facilities and service areas are shown in Figure 4-4 and are listed in Table 4-9. Approximately 32,000 acres on the west side of the county have planned development areas and remain unserved.

Figure 4-4. Municipal Wastewater Treatment Facilities

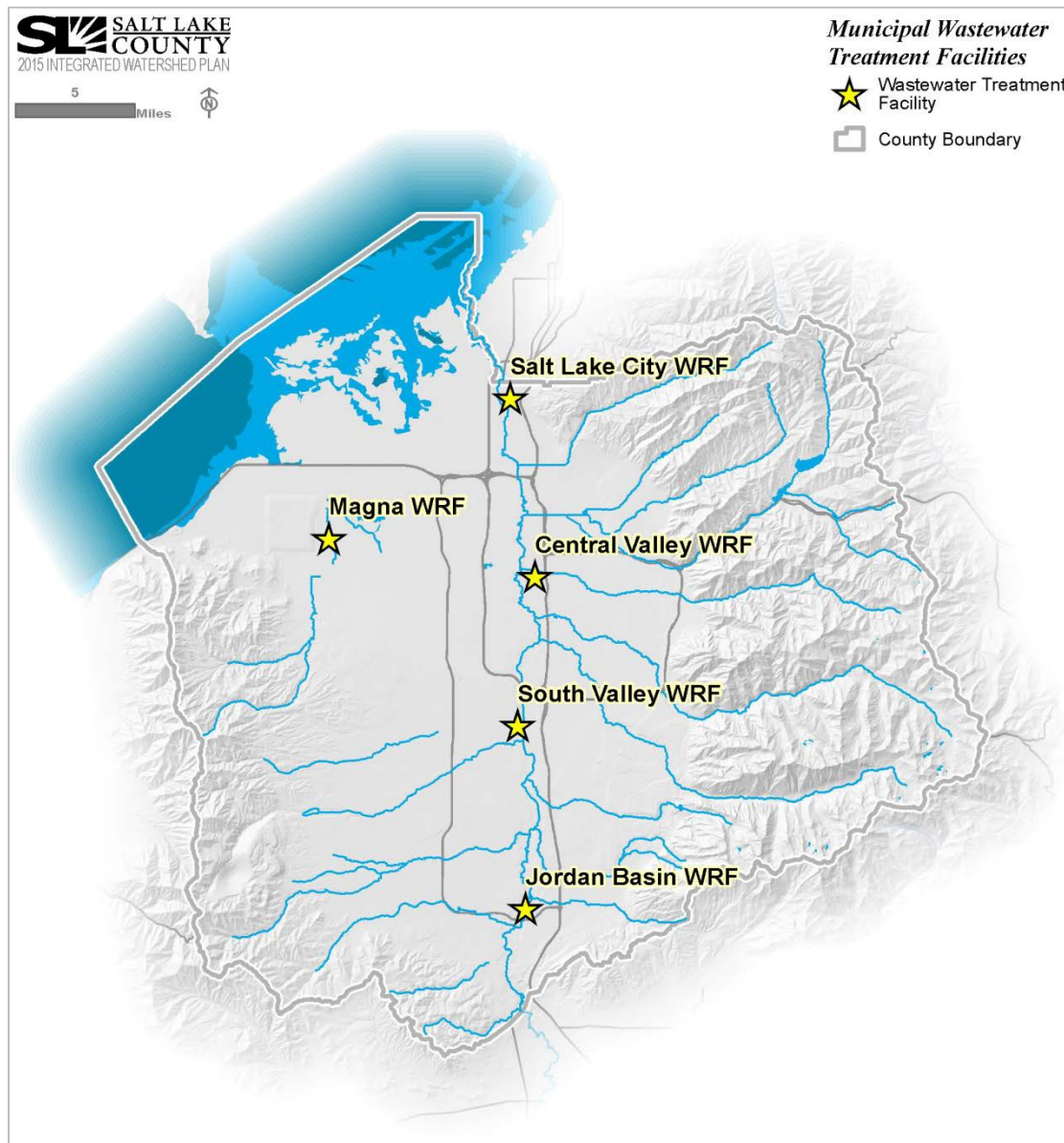

Table 4-9. Existing Municipal Treatment Facility Description and Capacities

Water Reclamation Facility / Receiving Water	Process Description	Existing Capacity (mgd)
Central Valley / Mill Creek	Trickling filter / solids contact	75.0
Jordan Basin / Jordan River	Biological nutrient removal membrane bioreactor	15.0
Magna Water / Kersey Creek	Oxidation ditch	4.0
Salt Lake City / Oil Drain	Trickling filter / activated sludge	56.0
South Valley / Jordan River	Biological nutrient removal and activated sludge	50.0

Biosolids

Disposal of biosolids (that is, residual solids or semi-solids obtained from treating wastewater) by application is regulated under Utah Code R315. Biosolids are managed to meet either Class A or Class B categories, based on the level of pathogens remaining in the biosolids after treatment. Class B materials have site and time restrictions for land application and disposal, whereas Class A biosolids can be applied and used more broadly.

The five treatment facilities listed above in Table 4-9 manage biosolids to meet permit conditions and meet Class A or Class B categories for disposal.

Reuse and Gray Water

Utah Code (R317-1) allows the use of treated domestic wastewater for Type I use (where human exposure is likely) and Type II use (where human exposure is unlikely). Currently, about 1 million gallons per day (mgd) of wastewater effluent are treated to meet Type I standards by Central Valley and are reused for golf course irrigation. Salt Lake City treats about 5 mgd and delivers the treated effluent to an adjacent constructed wetland pond.

Regulatory Trends

Federal, state, and local environmental regulatory agencies permit, monitor, and enforce activities related to the operation of municipal and on-site wastewater facilities. In addition to water quality regulations for discharges, other environmental regulations directly or indirectly affect wastewater conveyance, treatment, and disposal activities, including regulations that apply to solid and hazardous waste, air quality, stormwater discharges, and water rights. The following sections focus on recent regulatory actions regarding the discharge of nutrients and concurrent TMDL studies and implementation.

Nutrients. Municipal wastewater treatment facilities discharge nitrogen and phosphorous (collectively referred to as *nutrients*) in surface waters. High nutrient levels in surface waters can lead to harmful algal blooms and oxygen depletion, which results in impairment of recreation and aquatic beneficial uses. UDWQ limits phosphorous discharges to surface waters from municipal wastewater facilities through a technology limit rule. Effective in January 2015, the Technology-Based Phosphorous Effluent Limits (TBPEL) Rule (R317-1-3.3) requires certain municipal wastewater dischargers to meet a limit of 1.0 milligrams per liter (mg/L) limit for total phosphorous by 2020. In addition to the TBPEL, UDWQ is evaluating a total inorganic nitrogen limit of 10 mg/L, and EPA is recommending a future ammonia limit of 1.5 mg/L. These new and proposed limits are different in that they apply to all discharges from mechanical treatment facilities and do not depend on the receiving water-quality-based effluent limits (WQBELs), which are based on receiving-water beneficial uses and numeric water quality standards. There are differing opinions among regulators and the regulated community regarding the balance of the water quality improvements resulting from the investments required to achieve the nutrient reductions.

Meeting these existing and future limits will have significant effects on some of the facilities in the county, because of substantial investment in new technology and appropriate treatment processes

and facilities and increased operation and maintenance costs. The Jordan Basin facility currently achieves the existing and proposed nutrient limits. The South Valley facility started converting to biological nutrient removal processes in a phased approach, with Phase 1 completed in 2010 and Phase 2 scheduled for completion by 2020 (SVWRF 2016). Magna Water started an optimization study in 2015 to identify adjustments with the current processes to meet the standards.

Table 4-10 summarizes the potential effects of the existing phosphorous and proposed nitrogen and ammonia limits on municipal treatment facilities in the county. These improvements are the results of recent planning studies conducted by each treatment facility.

In an effort to study receiving water quality, standards, and improvements, the treatment facilities (excluding Magna Water) in Salt Lake County, and facilities in Davis and Utah Counties, formed the ad hoc Jordan River/Farmington Bay Water Quality Council (JRFBWQC) in 2009. JRFBWQC works with UDWQ and conducts studies to provide a scientific basis of understanding regarding how improvements to treatment processes and facilities would affect water quality conditions in receiving waters. These studies focus on the Jordan River, impounded wetlands, Utah Lake and tributaries, and Farmington Bay of the Great Salt Lake.

Table 4-10. Municipal Treatment Facility Planned Improvements

Water Reclamation Facility / Receiving Water	To Meet Phosphorous Effluent Limits (TBPEL) Rule		To Meet Potential Future Nitrogen/Ammonia Limits	
	Description of Planned Improvements	Estimated Costs	Description of Planned Improvements	Estimated Costs
Central Valley ¹ / Mill Creek	New 3-stage biological nutrient removal process	\$83 million	Expand to 5-stage biological nutrient removal process	\$152.5 million
Jordan Basin / Jordan River	None – Currently meeting limits			
Magna Water ² / Kersey Creek	Optimization study is currently being conducted			
Salt Lake City ³ / Oil Drain	Rehabilitation/upgrade of trickling filters, additional clarification, and chemical addition	\$78.4 million	New biological nutrient removal process	\$180.3 million
South Valley ⁴ / Jordan River	Phase 2 – conversion to nutrient removal processes	\$15 million	Included in current process conversion	

¹ Net-present-value costs to meet TBPEL include capital costs to convert from trickling filter to 3-stage Bardenpho-type process of \$ 77.7 million and \$5.3 million in annual expenses for 40 years. Net-present-value costs to meet nitrogen/ammonia limits are to convert to 5-stage Bardenpho processes of \$147 million and \$5.5 million of annual expenses for 40 years (CVWRF 2015).

² Source: Magna Water 2016

³ Net-present-value costs to meet TBPEL include \$75.7 million in capital costs and \$2.7 million in annual operating costs. Net-present-value costs to meet nitrogen/ammonia limits include \$176.9 million in capital costs and \$3.4 million in annual operating costs (SLCDPU 2014).

⁴ Source: SVWRF 2016

TMDL Studies and Implementation

As discussed in Section 3.1, Impaired Waterbodies, the Jordan River and many of the streams in the Salt Lake County are listed as impaired and are under TMDL implementation studies.

Impaired streams and the resulting TMDL studies could affect the municipal treatment facilities with pollutant loading restrictions and/or increased management procedures.

Municipal wastewater dischargers to the Jordan River, including Jordan Basin, South Valley, and Central Valley, are working with UDWQ for the TMDL Phase 1 studies for the lower Jordan River. These studies focus on oxygen depletion caused by organic matter and include reductions in discharges of organic matter for implementation in a phased approach. The Jordan River Segments 7, 6, and 5 (the Narrows to the confluence of Little Cottonwood Creek) have a cold-water fishery beneficial use and are currently impaired for temperature. Jordan Basin and South Valley are working with UDWQ to address the beneficial-use impairment for these segments.

TMDL studies for Emigration Creek, which has high levels of *E. coli* resulting in impairment of contact recreation uses, are focusing on the presence and condition of septic tanks. Other streams in the county that are also listed for *E. coli* include lower Big and Little Cottonwood Creeks, Butterfield Creek, Mill Creek, lower Parley's Creek, Rose Creek, and segments of the Jordan River. These streams and river segments are given a high-priority status by UDWQ for TMDL implementation.

New and Expanded Municipal Treatment Facilities

Consistent with area-wide water quality planning, this section describes activities conducted to plan and/or permit new facilities. Currently, the following new facilities and plant capacity expansions are under consideration:

- Central Valley is planning on expanding facility capacity to 85 mgd when the plant converts from the trickling filter to the biological nutrient removal process.
- SLCDPU is beginning a feasibility study to service the northwest quadrant of the city, based on land development activities (SLCDPU 2016). The northwest quadrant is geographically isolated from the current sewer system network, which conveys wastewater to the city reclamation plant at 2200 North. The study will evaluate a potential new facility located along I-80 on a parcel that Salt Lake City has owned for several decades and other options to convey and treat the wastewater generated in the northwest quadrant.

Summary

Five municipal wastewater treatment facilities provide wastewater treatment services and discharge effluent to receiving waters in the county. These facilities have a combined design capacity to treat and discharge about 75 mgd to Mill Creek, 65 mgd to the Jordan River, 56 mgd to the Oil Drain, and 4 mgd to Kersey Creek. These facilities provide treatment to member agencies servicing the developed areas of the county. About 32,000 acres along the west side of the county are planned for development and are currently not included in a service area for conveyance to an existing treatment facility. Other areas in the county are serviced by on-site wastewater disposal systems (septic systems) and are not treated by these existing facilities.

New and potential future regulatory nutrient discharge limits will affect four of the five treatment facilities. The 2015 UDWQ phosphorus discharge limits are technology-based with an implementation of 2020. Meeting these discharge limits will require new significant investment in new processes at Salt Lake City and Central Valley facilities and ongoing investments at South

Valley and Magna Water. Jordan Basin currently meets the new and potential future nutrient limits. In addition to effluent discharge limits, facilities are also required to meet applicable load reductions as prescribed in TMDL studies to return waterbodies to beneficial uses.

New discharges to receiving waters will require an update of this integrated watershed plan to identify effects on area-wide water quality.

4.4 Nonpoint Source Pollution Discharges - On-site Wastewater Disposal Systems

Nonpoint source pollution is conveyed and discharged to receiving waters from diffuse sources, as opposed to point source pollution which is conveyed to receiving waters from pipes or other human-made conveyances. There are nine categories of nonpoint source pollution including the broad category of land disposal, under which on-site wastewater disposal systems are identified as a pollution source that is regulated by federal, state, and local requirements.

This section is written to update information provided in the 2009 Plan, including: (1) provide a description of existing on-site wastewater disposal systems, referred to as septic tanks; (2) review authorities; and (3) discuss implications to septic system management and permitting with the implementation of TMDLs.

2009 Plan Summary

The 2009 Plan included a detailed analysis of the nine categories of nonpoint source pollution, regulations, authorities, and management plans. The nine categories discussed were agricultural runoff, urban runoff, construction runoff, hydrologic modification, habitat modification, mining, land disposal, silviculture, and a category described as *other* to capture atmospheric deposition, spills, and sources not covered under the other eight categories.

The analysis and findings of the nonpoint source pollution discussion in the 2009 Plan are incorporated by reference into this 2015 Plan.

Authorities

UDWQ has the authority to regulate septic systems through Utah Administrative Code R317-4, Onsite Wastewater Systems; R317-5, Large Underground Wastewater Disposal Systems; and R317-11, Certification Required to Design, Inspect, and Maintain Underground Wastewater Disposal Systems, or Conduct Percolation and Soil Tests for Underground Wastewater Disposal Systems. The rules require construction plan review and permitting for large on-site septic systems (those systems greater than 5,000 gpd). The rules also require certification of Onsite System Professionals to design, inspect, and maintain underground wastewater-disposal systems.

Additionally, local county health departments have the authority to regulate septic systems per Utah Code Annotated (UCA) Section 26A-1-114. The Salt Lake County Health Department regulates on-site wastewater disposal systems in incorporated and unincorporated area of Salt Lake County through Health Regulation #13, title Wastewater Disposal Regulation, which was last updated on September 5th 2013. It states onsite wastewater disposal systems shall be

maintained in a manner that prevents the surfacing of sewage, the creation of a nuisance, a public health hazard, or a menace to fish or wildlife. The update allows for alternative systems and to ensure compliance with the regulation, requires maintenance of both conventional and alternative systems. Furthermore the regulation gives the Health Department the authority to perform inspections, investigations, reviews and other actions as necessary.

Existing Septic Systems

Smaller residential communities and individual residences throughout the county are serviced by septic systems. Data provided by SLCOHD indicate that about 7,500 parcels throughout the county contain septic systems (SLCOHD 2016).

TMDL Studies and Implementation

As discussed in Section 3.1, Impaired Waterbodies, the Jordan River and many streams throughout the county are impaired for beneficial uses by varying pollutants. Eleven stream and Jordan River segments are currently listed for impairment of recreational use because of high levels of *E.coli* bacteria. Other streams in the county that are also listed for *E. coli* include lower Big and Little Cottonwood Creeks, Butterfield Creek, upper and lower Emigration Creek, Mill Creek, lower Parley's Creek, upper and lower Rose Creek, and segments of the Jordan River. Most of these streams and river segments are given a high-priority status by UDWQ for TMDL implementation (see Table 3-4).

Upper Emigration Creek is the only stream segment with ongoing TMDL studies and implementation planning. The focus of the implementation is the presence and condition of septic tanks serving residents and business in the watershed. The Emigration Improvement District (EID), which provides water and wastewater services for the unincorporated area of Emigration Township, has conducted a preliminary feasibility study focused on regional collection and treatment of wastewater that is now being treated on site by septic systems. This effort is a result of the upper Emigration Creek TMDL and the high concentrations of bacteria that have impaired beneficial uses.

Summary

On-site septic systems are currently regulated by state and local agencies and are the focus of increased management policies and procedures because of the impairment of recreational beneficial uses of nine stream segments and two Jordan River segments for *E. coli*.

If new discharges containing municipal wastewater are considered, an update to this 2015 Plan is required to evaluate effects on area-wide water quality.

4.5 Pilot Studies

This 2015 Plan includes two pilot studies that can be used to test approaches for planning related to water quality improvement. This section reviews the pilot projects, which include:

- A debris basin retrofit study for Spencer’s Pond, which can serve as a blueprint for other debris basin retrofits
- An instream flow analysis of Little Cottonwood Creek, which can serve as a blueprint for future instream flow analyses that focus on other creeks in the county

Debris Basin Retrofit Pilot Study

Salt Lake County operates several debris basins throughout the county that capture debris and sediment conveyed in stormwater runoff. The County conducted a Debris Basin Retrofit Pilot Study to evaluate possible ways to retrofit the basin to increase its efficiency at removing sediment and pollutants conveyed in stormwater runoff. Spencer’s Pond, a debris basin located on lower Big Cottonwood Creek in Cottonwood Heights, was chosen as the subject for the pilot. Once this basin has been fully analyzed and the design for the retrofit has been refined beyond what is presented in this 2015 Plan, and once the County has constructed the retrofit, the County could evaluate other basins for their suitability for similar retrofit improvements based on this methodology.

Background

Salt Lake County’s Flood Control Engineering Division (Flood Control) currently operates a total of nine debris basins on City Creek, Corner Canyon Creek, Emigration Creek, Mill Creek, and Big and Little Cottonwood Creeks (Figure 4-5). Flood Control also operates two debris structures on Parley’s Creek and Little Cottonwood Creek.

All of these facilities, which were built in the 1980s, are located along creeks to capture debris and sediment that originate upstream and are conveyed downstream. During snowmelt events, especially high-runoff events, the mountain streams carry woody debris, sediment, and cobbles downstream and into the urban storm drain network.

Figure 4-5. Debris Basins Operated by Salt Lake County’s Flood Control Engineering Division

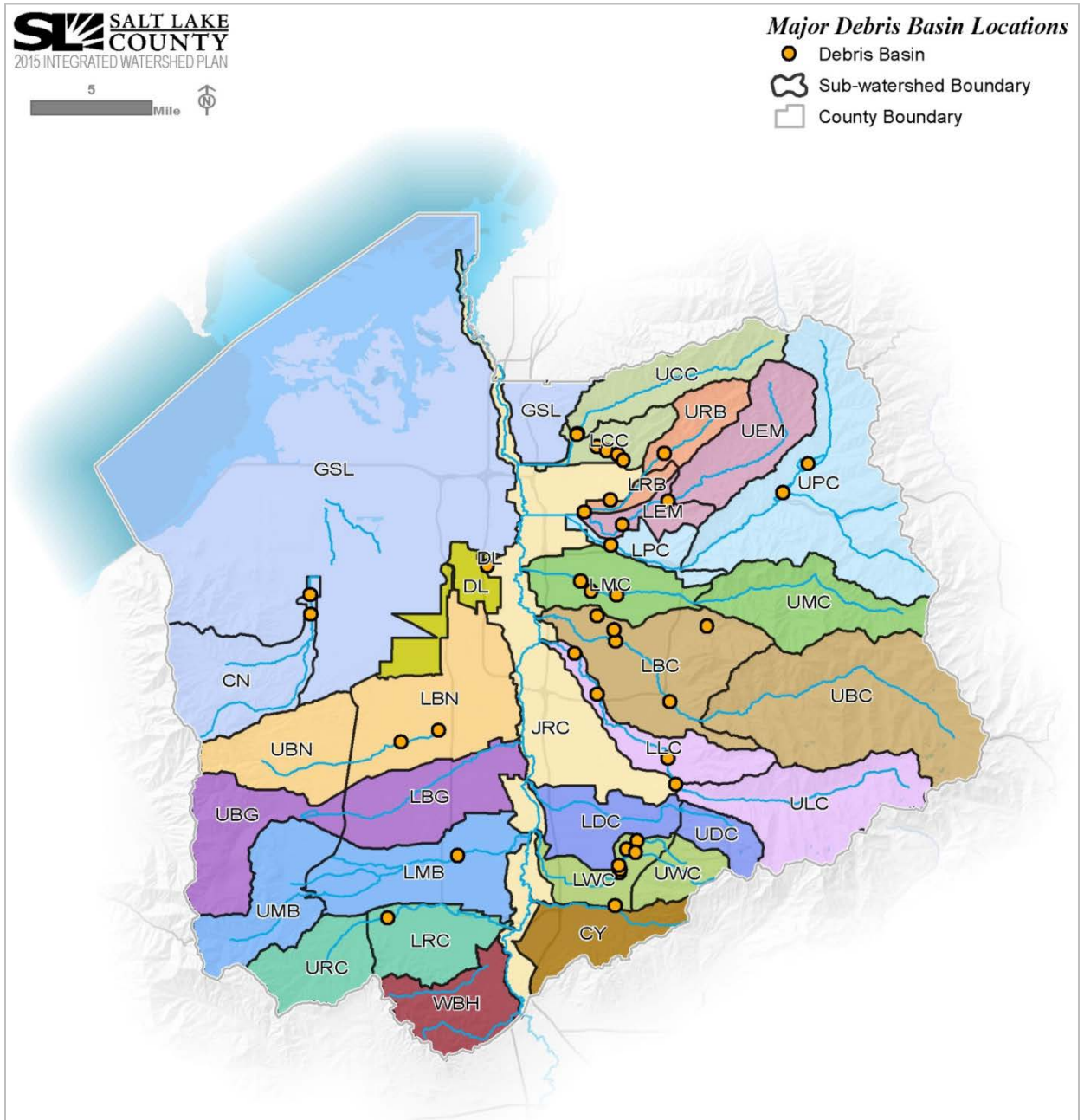

The purpose of the basins and structures is to capture debris and sediment before they are conveyed into the urban storm drain network where the debris and sediment could potentially cause clogs and lead to local flooding. Because creeks flow through these debris basins, the basins are not designed or operated to impound stormwater and are not considered detention basins. The County and other municipalities operate detention basins as part of the urban storm drain system. These detention basins are designed and operated to collect and detain stormwater before releasing it to a creek or to the Jordan River.

The debris basins are maintained and cleaned as needed. In years when the volume of water as a result of snowmelt is heavy, debris and sediment need to be removed from the basins and structures and disposed of. In years when the snowmelt-related volume is light, little debris collects in the basins, so they might not need to be cleaned out. If yearly snowmelt-related volume is light for several years in a row, the County might not need to clean out the basins for several years. Each basin is evaluated on a yearly basis.

The County chose the debris basin known as Spencer's Pond on Big Cottonwood Creek for the Debris Basin Retrofit Pilot Study. Spencer's Pond is located on Big Cottonwood Canyon Road at about 3200 East in Cottonwood Heights. This debris basin was chosen because stream flow data, topographic data, and design data for this basin are readily available.

Existing Condition Pollutant Removal Estimates

Table 4-11 lists amount of sediment removed from the nine debris basins in 2011, 2012, and 2013. In total, the County removed about 39,000 cubic yards (cy) (72.6 million pounds) of sediment from the nine debris basins during this period. The sediment removed from the nine basins represents about 63% of the total amount of sediment removed by Flood Control during this period. Other sediment was removed from the Jordan River, other creeks, and various detention facilities throughout the county.

As part of the Debris Basin Retrofit Pilot Study, Salt Lake County analyzed the amount of pollutants removed by the existing Spencer's Pond debris basin. In addition to helping the County understand how Spencer's Pond currently functions in terms of pollutant removal, analyzing the pollutants removed by the existing Spencer's Pond debris basin will help the County address Section 1.4.6 of its Municipal Separate Storm Sewer System (MS4) Permit (UPDES Permit Number UTS000001). Section 1.4.6 states that municipal stormwater discharges of pollutants into waters of the state that have a U.S. Environmental Protection Agency (EPA)-approved TMDL (as does the Jordan River) need to be consistent with that TMDL. The Debris Basin Retrofit Pilot Study focuses on reducing sediment discharges from the canyon watershed areas that are tributary to the Jordan River. The Jordan River's lower segments 1, 2, and 3 (north of 2100 South to the Great Salt Lake) have EPA-approved Phase 1 TMDLs for dissolved oxygen.

Table 4-11. Sediment Removed from Debris Basins in Salt Lake County (2011 - 2013)

Debris Basin ^a	Basin Area (acres)	Sediment Removed (cubic yards/pounds)		
		2011	2012	2013
Big Cottonwood Creek				
Creekside Park Basin 4800 South 1500 East, Holladay	0.24	None	1,390/ 2,500,000	None
Spencer's Pond Basin 6610 South 3180 East, Cottonwood Heights	6.0	1,780/ 3,302,000	7,970/ 14,800,000	None
City Creek				
Upper and Lower Memory Grove Basins 120 E. Bonneville Blvd., Salt Lake City	0.6	None	180/ 340,000	None
Corner Canyon Creek				
Corner Canyon Creek Basin 1500 E. Highland Drive, Draper	1.1	3,780/ 7,000,000	None	None
Emigration Creek				
Rotary Glen Park Basin 2850 E. Sunnyside Avenue, Salt Lake City	0.4	2,660/ 4,940,000	None	None
Little Cottonwood Creek				
Murray Park Basin 5065 S. State Street, Murray	0.25	None	4,500/ 8,360,000	940/ 1,740,000
Wheeler Historic Farm Basin 6351 South 900 East, Murray	0.75	None	8,370/ 15,550,000	None
Willow Creek Country Club Basin 8600 South 3030 East, Sandy	0.5	None	5,200/ 9,660,000	None
Mill Creek				
Scott Avenue Basin 3475 South 800 East, Mill Creek Township	0.3	1,860/ 3,450,000	360/ 675,000	100/ 180,000

Source: Salt Lake County Flood Control Engineering

^a For the general locations of these debris basins, see Figure 4-5, Debris Basins Operated by Salt Lake County's Flood Control Engineering Division.

Target Pollutants and Loadings

The primary target stormwater pollutant for the Spencer's Pond retrofit is sediment, measured as TSS (total suspended solids). Other pollutants being analyzed for the retrofit are total phosphorus (TP), 5-day biochemical oxygen demand (BOD5), total copper (TCu), total lead (TPb), total zinc (TZn), and volatile suspended solids (VSS). The County has conducted representative stormwater sampling and analysis since 1992.

The County's 2014 Stormwater Quality Technical Report (SLCO 2014) calculates and provides the most recent event mean concentrations (EMCs). EMCs represent the average pollutant concentration in stormwater discharges from unincorporated areas of the county to receiving waters. The EMCs are typically calculated and reported to meet municipal stormwater

compliance requirements. Other pollutants are also analyzed and reported in the County's 2014 Stormwater Quality Technical Report.

Table 4-12 shows the reported EMCs for 2013 for typical stormwater pollutants and the resulting stormwater load into the Spencer's Pond debris basin. The County's EMCs are used for the analysis because of the lack of sampling and analysis regarding the amount of pollutants conveyed by stormwater into receiving waters.

Table 4-12. Stormwater Pollutant Event Mean Concentrations (EMCs) and Stormwater Pollutant Loads in the Spencer's Pond Debris Basin (2013)

Pollutant	2013 EMC (mg/L) ^a	Calculated Ratio ^b	9-Month Load (lbs)
Total suspended solids (TSS)	137	—	3.0 million
Volatile suspended solids (VSS), calculated as % of TSS	Not available	0.3	900,000
Total phosphorus	0.53	—	11,600
5-day biological oxygen demand	14.7	—	321,250
Total copper	0.0427	—	900
Total lead	0.039	—	850
Total zinc	0.1559	—	3,500

^a Source: SLCO 2014

^b VSS/TSS ratio is an average that is calculated from the 29 outfall storm grab sample results.

The stormwater load into the basin is calculated using the stormwater EMCs and assuming a 15-cubic-feet-per-second (cfs) stormwater flow into the basin over 9 months (not including 3 months of snowmelt runoff) for the pollutants of concern using the equation

$$L = R \times C \times 6.342 \times 10^{-5}$$

where L = 9-month pollutant load, in pounds

R = 9-month stream flow volume, in cubic feet

C = pollutant concentration, in milligrams per liter (mg/L)

6.342×10^{-5} is a conversion factor

Since 2010, the County has sampled and analyzed stormwater runoff for VSS to better define and assess sediment discharged to receiving waters during stormwater events. However, the County has not calculated a VSS EMC because of the small numbers of samples collected and analyzed. In order to determine the 9-month load of this pollutant, VSS was calculated as a percentage of TSS. TSS laboratory analysis measures and reports the amount of sediment in a sample through a filtering, drying, and weighting process. With this process, only sediment passing through the filter is reported. The County determined correlations between VSS and TSS based on the analysis data for 29 storm events as documented in the 2014 Stormwater Quality Technical Report. The County estimated the VSS removed by the retrofits to the Spencer's Pond detention basin, as VSS is a measure of the amount of organic matter in suspended solids and this data could be related to the organic matter focus of the lower Jordan River TMDL.

Estimates of Snowmelt Pollutant and Sediment Removal in 2011

The County estimates that about 7,970 cubic yards of sediment were deposited in the Spencer's Pond debris basin as a result of snowmelt in 2011. This sediment was removed in 2012. The County calculated an average TSS concentration of the inflow into the debris basin based on the quality of the sediment removed in 2012, a review of the 2011 snowmelt flow data, and an estimate of sediment-removal efficiency.

This influent average TSS concentration is estimated at about 260 mg/L during the snowmelt runoff of 2011 based on the following parameters:

- Sediment load removed by the basin of 7,970 cubic yards (14.8 million pounds)
- Sediment removal efficiency of 60%
- Sediment load into the basin of about 13,300 cubic yards (24.7 million pounds)
- Average June and July 2011 stream flows of 386 cfs and 205 cfs, respectively, result in an average snowmelt duration of 60 days of flow at 295 cfs

Applying the VSS:TSS ratio of 0.3 would mean that the debris basin retained about 2,400 cubic yards (4.4 million pounds) of VSS during the 2011 snowmelt.

Conceptual Design for Spencer's Pond Retrofit

The purpose of the Spencer's Pond debris basin is to collect large, woody debris and sediment carried in Big Cottonwood Creek by snowmelt and stormwater. The basin is currently designed to fill up with collected sediment and debris; the County periodically removes the materials. Like all of the debris basins, Spencer's Pond is not designed to hold water. This primary function of collecting sediment and debris for later removal will not be compromised or changed by the proposed retrofit design.

The County's intent with the retrofit is to increase the amount of sediment collected during the non-snowmelt runoff period so that sediment can be prevented from entering the Jordan River year-round. Another design consideration, when determining appropriate vegetation for the swale and pond bottom, is that the water in Big Cottonwood Creek is sometimes entirely diverted for use as municipal drinking water. When this occurs, the stream flow doesn't reach Spencer's Pond, and the basin dries up.

As it planned the retrofit design, the County needed to make sure it met the following criteria:

- Does not compromise the primary function of the debris basin.
- Does not locate any retrofit element or woody vegetation along or immediately adjacent to the portion of the basin that is managed and regulated as a low-hazard dam.
- Does not provide the capability to detain stormwater, since the original design and construction do not accommodate that function.
- Provides elements to enhance sediment deposition from non-snowmelt stream flows and urban stormwater outfalls.

- Because the entire basin will fill with sediment over time, the retrofit elements can be reconstructed after the County removes sediment and debris from the entire basin (not just the retrofit elements).
- Is designed to accommodate lower flows since some of the flow will be diverted seasonally for drinking water supply.
- Provides maintenance access to allow sediment to be removed.

Existing Basin Conditions

Spencer's Pond is located on an approximately 7-acre site, with a 6-acre debris basin, outlet structure, and overflow structure (Figure 4-6). The site also contains a public parking area and a walking trail. The basin is maintained by Flood Control, while the walking trail and bridge across Big Cottonwood Creek are maintained by Cottonwood Heights.

Big Cottonwood Creek enters the basin from the east and exits the basin to the northwest. The basin has two structures that convey flows out of the basin: a low-flow outlet structure (discharge tower) and a high-flow overflow structure (spillway), both located at the northwest corner. The basin was constructed using a combination of above-ground berms and berm structures and below-grade excavated areas. The above-ground berm structures are managed in accordance with State of Utah Dam Safety requirements for high-hazard dams. These safety requirements protect the integrity of the berm structures and allow restricted improvements.

The current configuration of the basin allows stream flows to enter and leave the basin without detention or other water quality practices.

Figure 4-6. Spencer's Pond Existing Features

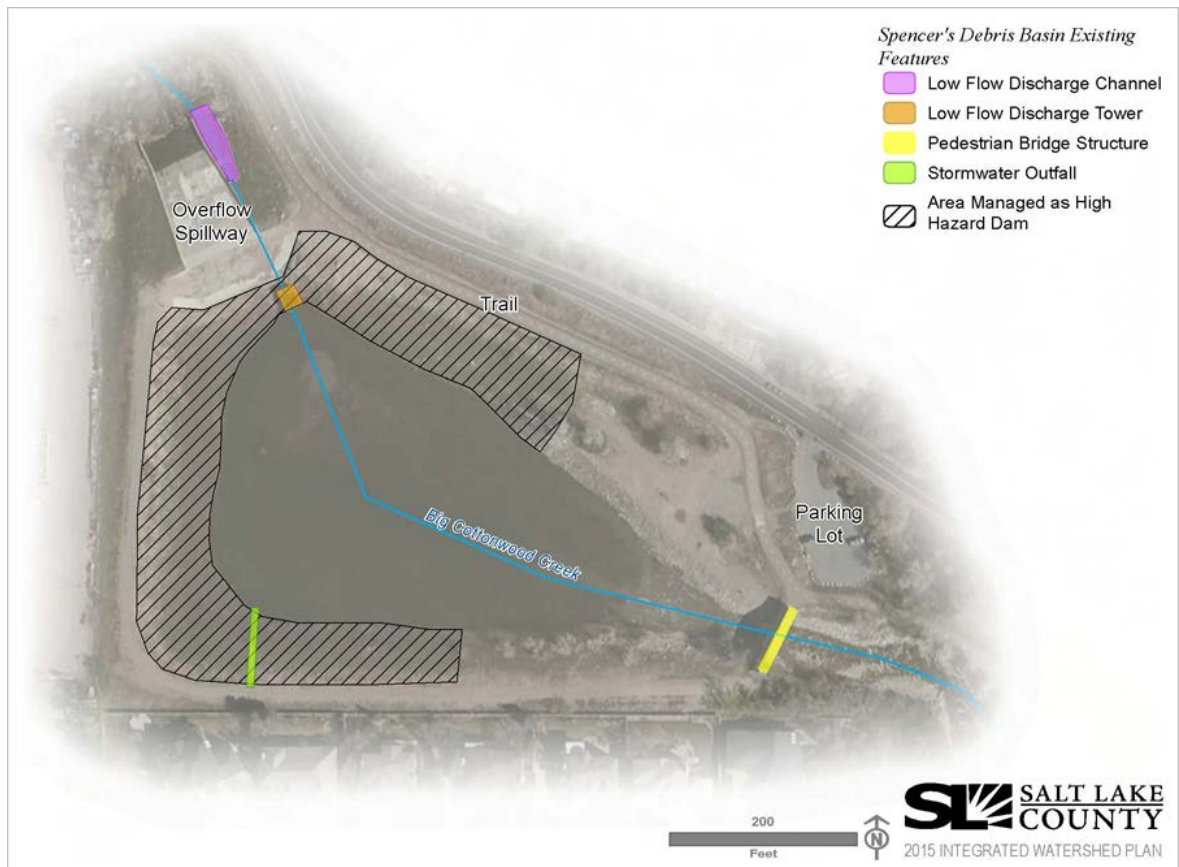

ood Control maintains and operates a stream flow gage (Gage Site 320) on Big Cottonwood Creek upstream of Spencer’s Pond, at about 4200 E. Big Cottonwood Canyon Road and 7200 South. The County analyzed the average monthly stream flows at the gage for the last 10 years to identify average snowmelt flows and average non-snowmelt flows (Figure 4-7). Because the gage is upstream of the Salt Lake City drinking water treatment plant diversion, when the stream flow is completely diverted for water supply purposes, the amount of flow that is conveyed to Spencer’s Pond is less than the flow measured at the gage.

Figure 4-7. Average Monthly Stream Flow at Gage Site 320

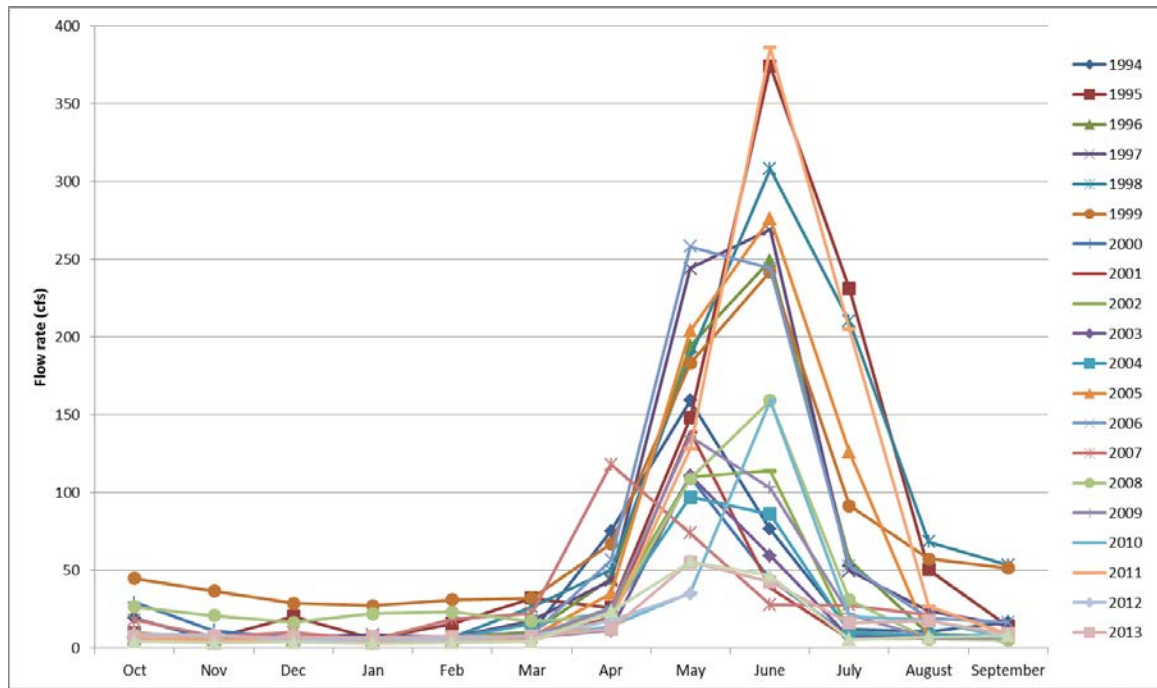

According to these data, snowmelt runoff events typically occur in Big Cottonwood Creek for 3 months of the year (May, June, and July), and the creek has non-snowmelt stream flows during the remaining 9 months of the year. As part of the planning process for the retrofit, the County analyzed the average monthly stream flow data for the last 10 years to determine maximum, average, and minimum flows at Gage Site 320 (Table 4-13). Using these data, the County determined that a stream flow of 15 cfs, a flow slightly above the average non-snowmelt flow, should be used to size the retrofit elements for Spencer’s Pond.

Table 4-13. Snowmelt and Non-snowmelt Maximum, Average, and Minimum Stream Flows at Gage Site 320

In cubic feet per second (cfs)

Stream Flow Type	Maximum Flow	Average Flow	Minimum Flow
Snowmelt (May, June, and July)	291	119	22
Non-snowmelt	49	14	5

Retrofit Basin Elements

To begin the retrofit process, the County would first remove any accumulated sediment to restore the original design elevations of the Spencer’s Pond basin. The County would then retrofit the basin with three water quality elements: an earthen forebay, a vegetated swale, and a concrete micropool. These elements are shown in Figure 4-8.

What are water quality elements?

Water quality elements are individual features that can be used independently or in combination to remove pollutants from stormwater through mechanisms such as filtration, sedimentation, and infiltration.

Figure 4-8. Concept Design Elements for the Spencer’s Pond Retrofit

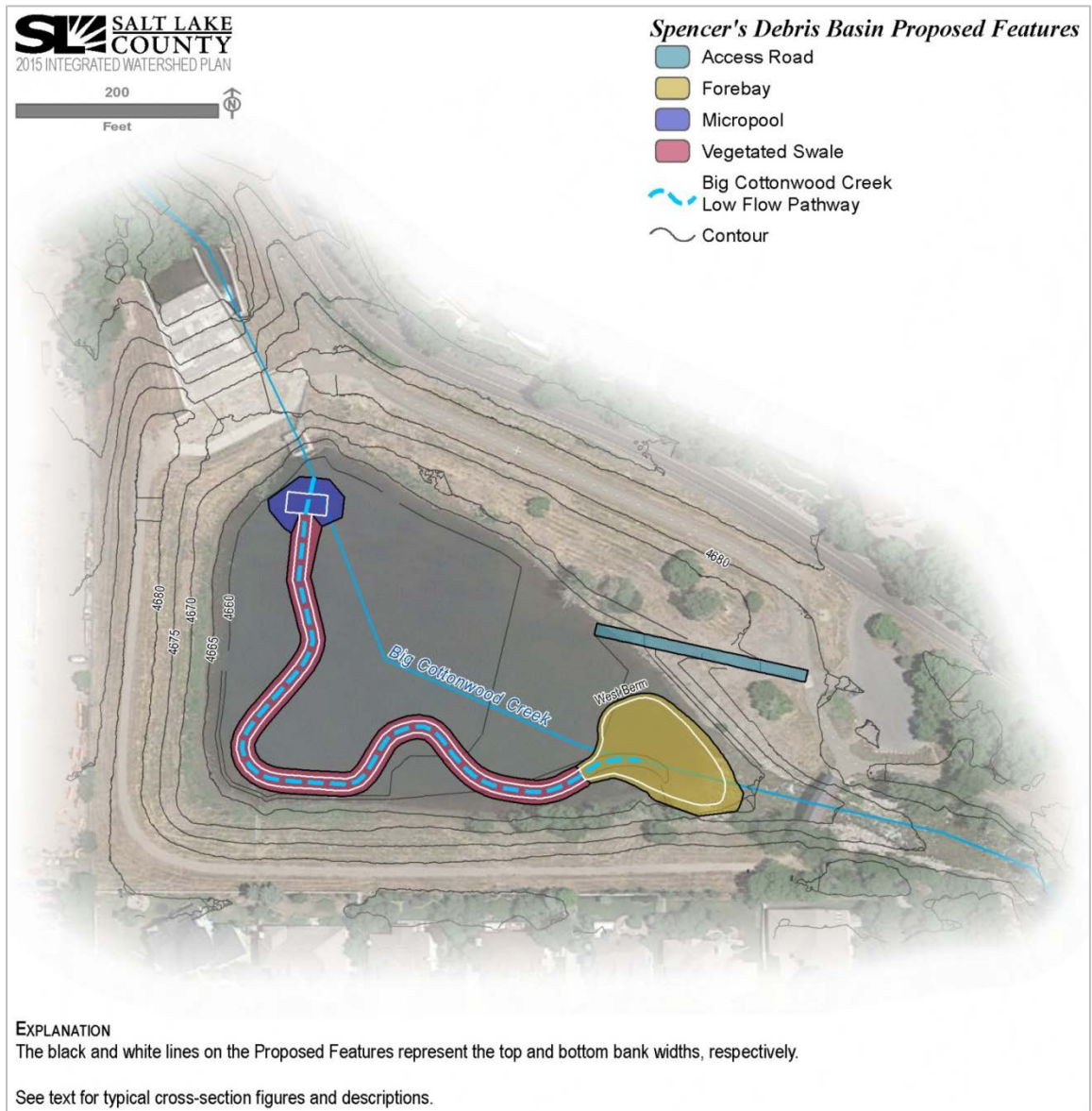

In combination, these three elements are designed to hold about 1,100 cy of sediment (this is in addition to the current capacity of the basin). The County predicts that sediment will need to be removed from the three water quality elements annually but that it might not need to remove

sediment and debris from the entire basin on the same schedule. However, because the entire basin itself will periodically fill up with sediment, the County will still need to periodically clean out the entire basin. When this occurs, the forebay and vegetated swale will need to be reconstructed once the total cleanout is completed.

The following paragraphs provide a basic description of the three retrofit elements. If this project moves forward with implementation, the County will refine the design of each element.

Forebay

The forebay will be a depressed area on the eastern side of the pond close to the maintenance access road and will connect to the beginning point of the vegetated swale. The purpose of the forebay is to pre-treat the water before it enters the primary water quality structure (in this case, the vegetated swale). The forebay will capture flow and allow coarse sediment to drop out of the water before the water is conveyed to the vegetated swale. This arrangement will provide two main benefits: (1) easier maintenance (since there will be a single location for removing sediment) and therefore less maintenance required for the longer vegetated swale; and (2) additional capacity for removing sediment.

The forebay will be an excavated area with a shallow earthen bottom and sides that transition to the vegetated swale on the western side of the forebay. It will be about 0.2 acre and about 1.5 feet deep and will have a capacity to hold about 480 cy of sediment, as shown in Figure 4-9. When the stream flow entering the basin is 15 cfs or less, all flow will be directed to the forebay and down the vegetated swale. When the stream flow is greater than 15 cfs, the forebay will naturally fill up with water, and water will overflow into the main basin and continue flowing through the vegetated swale.

What is a forebay?

A forebay is a constructed depression located in front of a larger pool or basin designed to remove sediment by deposition.

Figure 4-9. Typical Cross-Section through Forebay

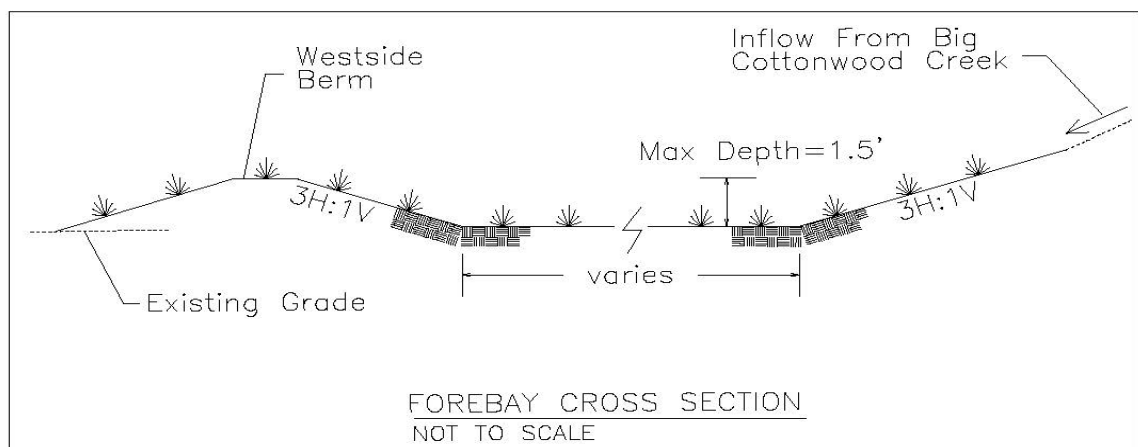

As described above, the County will construct the forebay after all accumulated sediment is removed from the existing debris basin, and the basin is brought back to its original design elevations. Depending on the amount of sediment that it captures, the forebay is designed to be

maintained by removing accumulated sediments annually. The County will monitor this debris basin and might need to modify the forebay dimensions in the future if it finds that the original design does not operate as expected (that is, captures less coarse sediment than expected). Periodically, the entire basin will need to be dredged. When this occurs, the forebay will need to be reconstructed once the cleanout is completed.

Flow that enters the forebay will be directed to the vegetated swale.

Vegetated Swale

The vegetated swale will be the primary structure for removing pollutants from water flowing into the basin. These pollutants will be removed via filtration and sedimentation.

Consistent with the design of the forebay, the swale will convey stream flow of 15 cfs or less with a velocity of about 1.6 feet per second (fps). The swale will have a shallow slope and meandering alignment to reduce the speed of the water as it is conveyed to ensure that swale materials are not eroded and carried downstream. This design allows pollutants to be removed from the stormwater by three processes: (1) pollutants are filtered out by the grass vegetation; (2) there is increased contact time to allow biological uptake; and (3) sediment can settle out of the water while not eroding the swale.

The swale will meander from the eastern edge of the basin to the southern edge, then north to the micropool (Figure 4-8 above). This path allows the swale to be located away from the toe of the high-hazard dam and still receive and convey flow from an existing stormwater pipe that discharges into the basin as well as from the forebay.

The total length of the vegetated swale will be nearly 640 feet with a constant 12-foot bottom width and a total depth between 1 and 1.5 feet. The swale's volume will be about 500 cy, as shown in Figure 4-10.

What is a vegetated swale?

A vegetated swale is a shallow drainage channel lined with vegetation that is designed to reduce flow velocity in order to remove pollutants through filtration, biological uptake, and sedimentation.

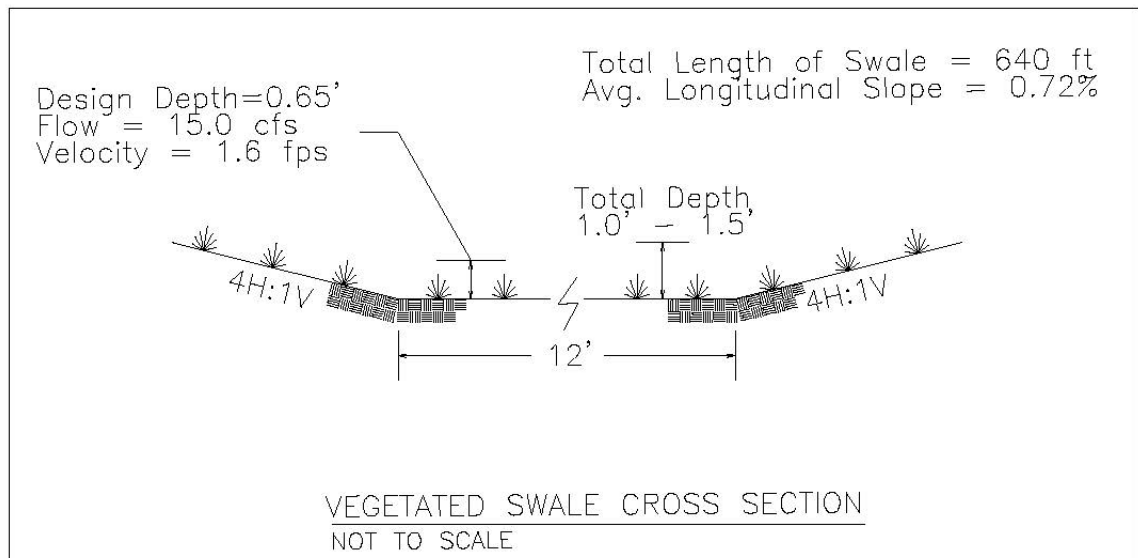
Figure 4-10. Typical Cross-Section through Vegetated Swale

During the initial construction phase, the swale will be excavated after the County removes accumulated sediment from the entire basin. Once excavated, the swale and the basin will be seeded with a native grass mix.

Periodically, the entire basin will need to be dredged and cleaned out. When this occurs, the swale will be reconstructed and revegetated.

Micropool

The micropool will capture and contain water to increase sediment removal and reduce resuspension of sediment. By removing and controlling the sediment, the micropool will prevent sediment-related clogging of the low-flow outlet tower.

The micropool will be constructed with a concrete bottom to contain water and to facilitate maintenance. With a permanent depth of about 2.5 feet, the micropool will hold non-snowmelt water intermittently depending on the volume of the stream flow.

The micropool's volume will be about 120 cy. The bottom dimensions of the micropool will be 2.5 feet deep and about 20 feet by 40 feet. Side slopes will be kept at a minimum 4:1 ratio, as shown in Figure 4-11.

What is a micropool?

A micropool is a depressed area, located upstream of an outlet structure, to increase sediment removal and control resuspended solids and floating debris. It is normally constructed out of concrete to facilitate maintenance.

Figure 4-11. Typical Cross-Section through Micropool

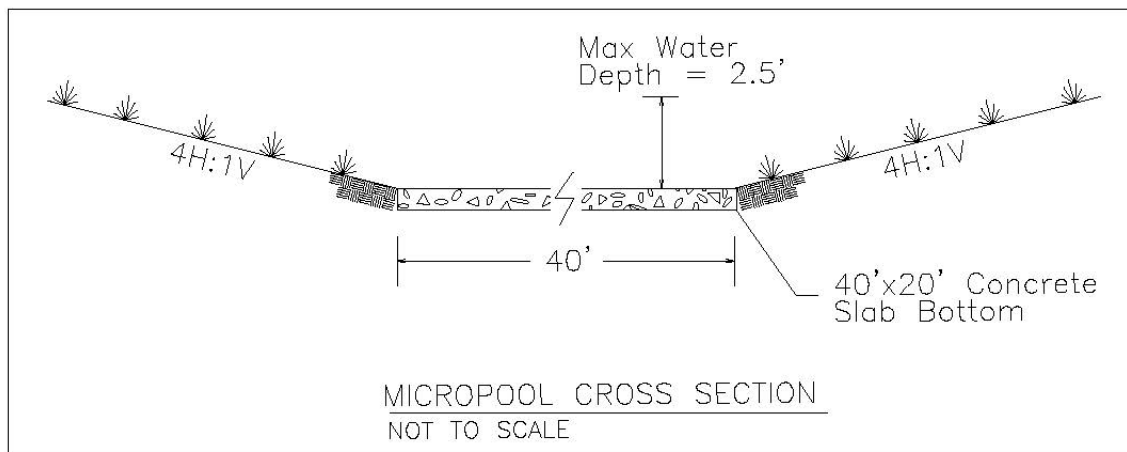

Like the other retrofit elements, the County will construct the micropool after removing accumulated sediment from the entire basin. Unlike the other elements, because of its concrete bottom the micropool will not need to be reconstructed after the entire basin is periodically cleaned. The micropool is designed to have accumulated sediments removed annually.

Additional Elements

In addition to the forebay, vegetated swale, and micropool, the County will also incorporate the following elements to provide efficient and effective maintenance and basin management:

- Install survey monuments when the pond is retrofitted to facilitate removing sediment and locating and restoring the retrofit elements after sediment is removed in subsequent years.
- Construct a new maintenance access road on the north side of the basin to facilitate access to the basin, maintenance of the forebay, and sediment removal from the entire basin.
- Seeding and weed control will occur after sediment has been removed from the entire basin and the forebay and swale have been constructed both during the initial construction and subsequent reconstructions. Broadcast seeding will be used in the entire basin, including within the swale, and along the maintenance access road. The seed mix will consist of drought-tolerant native grasses and will be certified weed-free. Because it has a concrete bottom, the micropool will not be seeded. In accordance with Utah dam safety requirements, no woody (tree or shrub) species will be included in the seed mix.

Expected Pollutant Removal with the Spencer's Pond Retrofit

For this analysis, to understand the potential efficiency of the retrofitted Spencer's Pond, the County conducted a literature search to identify pollutant-removal efficiencies (percentages) for the proposed retrofit elements. As more water quality data are collected upstream of the debris basins, further analysis of removal efficiencies could be modeled using hydrologic and water

quality software. However, at this time, the County determined that using pollutant-removal efficiencies found in the literature would be most appropriate.

Most research that the County found reported the *average* percent removal of pollutants provided by water quality elements. For the retrofitted basin, the primary water quality treatment will be provided by the vegetated swale, so the County focused on literature that looked at vegetated swales. Table 4-14 lists the efficiencies reported by various research sources.

Table 4-14. Stormwater Pollutant-Removal Efficiencies for Swales

In percent (%)

Water Quality Element	TSS	VSS	TP	BOD5	TCu	TPb	TZn
Open channel ^a	81	—	24	—	65	—	71
Vegetated swale ^b	65	—	25	—	—	—	—
Swale ^c	81	—	9	67	51	67	71
200-foot-long grass swale ^d	83	100	29	—	46	67	63
100-foot-long grass swale ^d	60	86.4	45	—	2	15	16

^a Source: CWP 2007

^b Source: NHDES 2008, Appendix B

^c Source: EPA 1999

^d Source: WisDOT 2007

Based on this research, the County used these pollutant-removal efficiencies to calculate the amounts of pollutants that would be removed by the proposed vegetated swale conveying non-snowmelt stormwater flows through the debris basin (Table 4-15).

Table 4-15. Estimates of Stormwater Pollutant Loads Removed by the Proposed Vegetated Swale

Pollutant	9-Month Load in Influent (lb)	Percent Removal (%)	9-Month Load Removed (lb)
Total suspended solids (TSS)	3.0 million	60	1.8 million
Volatile suspended solids (% of TSS) ^a	900,000	60	540,000
Total phosphorus	11,600	25	2,900
5-day biological oxygen demand	321,250	—	—
Total copper	900	56	500
Total lead	850	70	600
Total zinc	3,500	69	2,400

^a VSS estimates are based on the TSS load and removal quantities multiplied by the ratio of VSS to TSS.

The County estimates that the annual amount of 1.8 million pounds of sediment retained by the swale will result in a deposition of about 950 cubic yards, based on an average sediment weight of about 1,900 pounds per cubic yard.

Cost Estimate

The County estimates that the cost to design and construct the water quality elements for the retrofitted Spencer's Pond debris basin is about \$307,395. This estimate contains the following elements: final design and construction drawings, construction activities contingency, and monitoring costs, as shown in Table 4-16.

Table 4-16. Estimated Design and Construction Costs for the Spencer's Pond Debris Basin Retrofit

Construction Element	Unit	Quantity	Unit Cost	Total Cost	Comments
Weed mitigation	Acre	6	\$170	\$1,020	
Soil excavation and disposal	CY	13,500	\$12	162,000	Construct forebay, swale, micropool and access road
Concrete	CY	15	\$120	\$1,800	Micropool
Structural fill and 6-inch gravel	CY	220	\$30	\$6,600	Access Road
Survey monuments	Each	6	\$75	\$450	To be placed around the basin
Vegetation, seeding	Acre	6	\$250	\$1,500	Native grass mix
Total construction estimate				\$173,370	
Final design and permitting (10%)				\$17,350	
Construction management (20%)				\$34,675	
Contingency (30%)				\$52,000	
Inflow and outflow water quality monitoring				\$30,000	2 years, 9 months, 2 monthly grab samples
ESTIMATE OF TOTAL PROJECT COSTS				\$307,395	

In order to estimate the cost per pound for removing additional sediment from Big Cottonwood Creek because of the retrofitted water quality elements, the County made the following assumptions:

- 950 cy (1.8 million pounds) of sediment retained each year from non-snowmelt stormwater flow
- Annual maintenance costs of \$5,700 to remove the accumulated sediment (based on removal of 950 cy per year at \$6/cy)
- 5 years between major snowmelt events that would warrant removing sediment from the entire basin and reconstructing the water quality features

With these assumptions, and adding the project costs of \$307,395 (Table 4-16 above) and 5 years of annual maintenance costs (\$28,500), the total cost of retrofitting Spencer's Pond would be \$335,895 to remove 4,750 cy (8.8 million pounds) of sediment over 5 years. Therefore, the estimated 5-year project capital and maintenance costs are estimated at \$0.04 per pound of sediment removed.

Summary

The County conducted this Debris Basin Retrofit Pilot Study to begin exploring the feasibility of retrofitting an existing debris basin with water quality elements to reduce the amount of sediment and other pollutants conveyed by non-snowmelt runoff events to the Jordan River.

The County operates nine debris basins, which have the primary purpose of removing debris and sediment transported during snowmelt runoff events and preventing the debris and sediment from being conveyed downstream and ultimately to the Jordan River. These debris basins are periodically cleared of accumulated debris and sediment. The County's records indicate that the County removed about 39,000 cy (72.6 million pounds) of sediment from the nine debris basins during 2011–2013.

Overall, the proposed retrofits would not change the primary purpose of the debris basins. This study evaluated retrofitting one of the County's basins to enhance the basin's capacity to remove additional sediment conveyed by non-snowmelt runoff events. The debris basins would continue to serve their initial purposes of collecting snowmelt-related runoff, so the entirety of each basin would still fill with accumulated sediment. Because the County will periodically remove sediment from each entire basin, the retrofit elements would need to be fully or partially reconstructed accordingly.

The County selected Spencer's Pond on Big Cottonwood Creek as the focus of this pilot study. The study evaluated increased removal of target pollutants, including sediment (represented by TSS) and organic solids (represented by VSS), using additional, constructed water quality elements: a forebay, a vegetated swale, and a micropool. The study conceptually designed and analyzed the elements in order to estimate design flow, inflow pollutant concentrations, the amount and type of sediment and other stormwater pollutants retained, and capital and maintenance costs.

The County used representative stormwater sampling results and average inflow pollutant concentrations to estimate the non-snowmelt inflow pollutant concentrations. Pollutant-removal efficiencies were applied to the inflow concentrations. The County estimates that, with the retrofit, Spencer's Pond would capture and retain about 950 cy (1.8 million pounds) of sediment, 290 cy (0.54 million pounds) of organic matter (VSS), and various amounts of other pollutants (phosphorus, copper, lead, and zinc) annually. This pollutant reduction is directly applicable to the Jordan River TMDL effort to reduce organic matter discharged to the Jordan River.

Based on the capital costs and 5 years of operation and maintenance, the study estimated that the retrofitted Spencer's Pond would remove 4,750 cy (8.8 million pounds) of sediment at a cost of \$0.04 per pound of sediment removed.

Instream Flow in Little Cottonwood Creek Pilot Study

As a follow-up to the instream flow analysis conducted for the 2009 Plan, the County conducted a detailed analysis to determine the quantity of water required to provide minimum perennial flow to sections of Little Cottonwood Creek. This analysis is documented in the Little Cottonwood Flow Study prepared by the County and is summarized in this section (SLCO 2016).

Reduced or interrupted flows in perennial streams, including areas of Little Cottonwood Creek, create stressed conditions for aquatic habitat and riparian vegetation. The results of this pilot study determine a minimum stream flow, such that the County can use this information and begin discussions to provide for continuous base flows to increase stream function and watershed health. The scientific process to determine the minimum flows can be used on other creeks in the county with interrupted or reduced flows.

The determination regarding how much water will be required is based on the objective to provide a consistent minimum base flow for sections of Little Cottonwood Creek that have natural perennial flows reduced by upstream diversions. *A minimum base flow is defined as the amount of flow needed to maintain pool-to-pool connectivity and sustain a riparian community.*

2009 Plan Summary

The 2009 Plan included a detailed analysis of the existing stream flow gage data and stream conditions in the county to support the strategic target of increasing or restoring interrupted and reduced stream flows under normal and drought conditions to support habitat and recreational functions. Hydrologic modifications of stream flows through diversions (removing flow from stream channels) and canal overflows (discharging flow from irrigation canals to streams) have caused adverse effects on water quality, stream channel stability, and riparian and aquatic habitat (2009 Plan). The 2009 Plan identified mainstem stream flows as intermittent, intermittent reduced, intermittent interrupted, perennial, perennial reduced, perennial reduced with exchange, and perennial interrupted.

The 2009 Plan identified segments of Big Cottonwood and Little Cottonwood Creeks as the #1-ranked priority for flow augmentation feasibility studies, based on effects on habitat, stream stability, and community as a result of reduced and interrupted stream flows. The 2009 Plan identified a target minimum water depth of 6 inches to provide for fish habitat and a preferred target of 12 inches of water depth for fish passage (pool-to-pool connectivity).

Background

Little Cottonwood Creek flows from the headwaters of Little Cottonwood Canyon near the Albion Basin and Grizzly Gulch areas about 23 miles to the Jordan River at about 4800 South. Upper and lower Little Cottonwood Creek watersheds have a drainage area of over 25,000 acres and range in elevation from 11,200 feet to 5,200 feet.

Water flows in the upper sub-watershed creek (high canyon areas) in a perennial reduced regime, as some water is diverted into upper sub-watershed lakes (Secret, Red, and White Pine Lakes). The Murray Hydroelectric Plant and other diversions route water away from the creek for culinary, power, irrigation, and conservation uses (SLCO 2009). As a result of these diversions, the Little Cottonwood Creek main channel below the power plant diversion is considered perennial interrupted, which means the creek is dry or ephemeral (flows as a result of rainfall events) most years from the time snow melt runoff ends through the time it begins the next year. Springs replenish the creek flows west of the Crestwood Park area. Lower segments of the creek are categorized as perennial, with interrupted flows due to diversions. Water is introduced to

segments of lower Little Cottonwood Creek below the study area, as a result of water right exchanges.

The current pilot study focuses on the segment of Little Cottonwood Creek from the Murray Hydroelectric Plant to Crestwood Park near Highland Drive. This segment is referred to as the study area and shown in Figure 4-12.

Effects of Reduced Stream Flows

The Little Cottonwood Creek main channel at the Wasatch Resorts community has been reported as sustaining a lush riparian plant community that has given way to dry gulches flanked by upland grasses, forbs, and shrubs. This change in vegetation community can be attributed to the lack of water due to the reduction and interruption of stream flows.

In 2010 and 2011, the mountain watersheds received significant snowfall followed by high temperatures, resulting in a rapid snowmelt/runoff event. Stream flows generated by the snowmelt were estimated to approach flows expected from an 84-year storm event for 2010 and a 92-year storm event for 2011. For comparison purposes, a 100-year storm has a 1% chance of occurring each year and is traditionally used to predict flood flows. These runoff events caused significant flooding, bank erosion, and steam instability that resulted in over \$7 million of flood-control improvements, including rebuilding and stabilizing stream banks, constructing new stream culverts, and implementing other mitigation measures along several of the east-side stream corridors. Figure 4-12 shows the Little Cottonwood Creek locations that were damaged by the 2010 and 2011 high-snowmelt events.

The County conducted a spatial analysis of the dewatered section of Little Cottonwood Creek and the damage locations. This analysis led the County to conclude that the Little Cottonwood Creek segment with reduced flows experienced more-frequent stream bed and bank damage than did other streams with continuous stream flows. Although there are other possible explanations for the excessive damage sustained in this stream segment area the County believes that some, or even much, of the damage sustained in 2010 and 2011 was caused by the following:

- a lack of riparian vegetation and the flood flow buffering and bank stabilization capacities that vegetation provides
- changes to the consolidation of particles found in perennial vs. ephemeral streams (significant loss of consolidation and corresponding decrease in shear stress required to move sediment)
- sediment transport changes due to the loss of the transport mechanism and increased volume of moveable sediment
- increased seasonal stream power due to pool filling (deposition) and run and step scour
- increased upper bank erosion due to the loss of vegetative protection
- increased fine sediment from upper bank mass wasting
- changes in vegetative type and infrastructure that is incompatible with the native and naturally occurring stream type as determined by valley type and discharge.

Figure 4-12. Little Cottonwood Creek Study Area

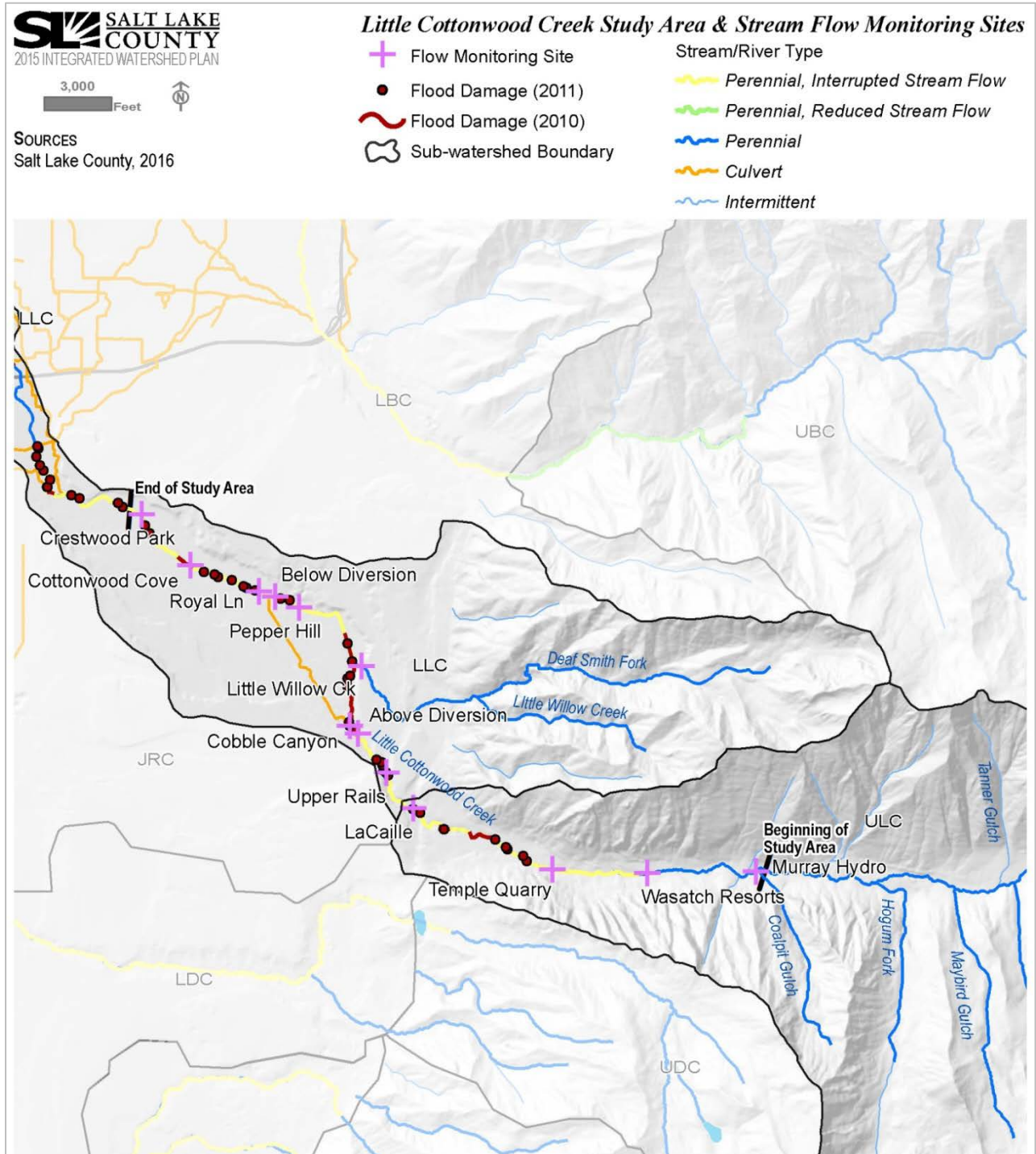

Instream Flow Analysis

In 2015, the County conducted field measurements, collected stream flow gage data, and conducted a computerized hydraulic analysis to support the determination of minimum instream flows to meet the goals of maintaining pool-to-pool connectivity and supporting riparian habitat (SLCO 2016). The County developed and implemented a study plan that relied on multiple methodologies to determine the minimum instream flow required. The study plan included evaluating stream bed and bank characteristics, analyzing existing flow, and conducting hydraulic modeling at multiple sites throughout the affected stream segment.

Figure 4-12 shows the study area and the 10 stream flow monitoring (reference) sites. The study area was a 25,000-foot segment of Little Cottonwood Creek, from the Murray Hydroelectric Plant to Crestwood Park near Highland Drive.

At each of the 10 reference sites, the County collected stream flow data and stream channel characteristics (wetted perimeter, soils, and pebble counts) during the seasonal rising and falling flow regimes as a result of the 2015 snowmelt runoff. To collect flow data, one transect was selected at each site in a riffle where banks were well defined, the streambed had a relatively consistent depth, water was mostly free of obstructions to flow such as rocks and logs, and eddies, still water, or turbulent water were absent. The County's selection of reference sites also depended on the sites' accessibility and proximity to water diversion structures. Stream channel locations containing flumes, weirs, outfalls, and other structures were avoided. Stream flow velocity and flow area measurements were taken to calculate the instantaneous flow at each of the 10 sites.

Channel material data were collected by conducting a Wolman pebble count, measured with a standard U.S. Geological Survey (USGS) gravelometer. One hundred pebbles were selected at random across the width of the stream, measured, and recorded for future comparison of particle distribution and stream competence. Soils were mapped using the Natural Resources Conservation Service's (NRCS) SoilWeb application, which provides access to USDA-NCSS detailed soil survey data, including soil descriptions, approximate distributions, and saturated hydraulic conductivity estimates.

The County estimated stream flow losses due to infiltration based on channel bed and bank material characteristics (sand, Knutsen coarse sandy loam, and Knutsen cobbly coarse sandy loam) and corresponding saturated hydraulic conductivities and stream channel width. Estimated flow losses through the study area ranged from 11 cfs to 14.6 cfs. These estimates were compared to field measurements, which were conducted multiple times during spring snowmelt runoff because soils were saturated and the variation of stream flows could be captured (Table 4-17).

Flows into (from Little Willow Creek) and out of (to Cutoff Savings Ditch) Little Cottonwood Creek were measured for and accounted accordingly (that is, flow taken from the stream or added to the stream from the ditch was not included in the infiltration loss calculation). The County estimates that these calculated flow losses and measured flow losses have a 12% error, which is considered acceptable and validates the methodology followed.

Table 4-17. Measured Flows in Little Cottonwood Creek (2015)

Stream / Stream Location	Measured Stream Flows (cfs)		
	May 19	May 29	June 18
Little Cottonwood Creek / Above Cutoff Savings Ditch diversion	87.3	96.6	0
Little Willow Creek / Confluence with Little Cottonwood Creek	0	0	3.54
Little Cottonwood Creek / Below Cutoff Savings Ditch return	76.1	87.5	0.7

Source: SLCO 2016

To estimate the amount of flow required to maintain pool-to-pool connectivity through the study area, the data collected at the 10 reference sites were entered into Hydraflow Express, an open-channel-flow hydraulic modelling program. This program analyzed the slope of the channel and cross-sectional characteristics to predict likely in-stream water flows to meet designated minimum water depths.

Table 4-18 summarizes flow quantities predicted by model simulations at each of the 10 sites (upstream to downstream) for three sets of conditions: (1) maintenance of 6 inches of water depth; (2) riffle sections with no significant flow depth as designated by particle size D50 (that is, 50% of stream bed materials with diameters of less than the designated size should not be covered by flowing water in riffle facets); and (3) riffle sections with no significant flow depth as designated by particle size D84 (that is, 84% of stream bed materials with diameters of less than the designated size should not be covered by flowing water in riffle facets).

Particle size distribution is the number of particles that fall into each of the various size ranges given as a percentage of the total number of all sizes in the sample of interest. D50 and D84 are typically used as representative grain sizes for sediment: D50 is the median grain size and D84 the 84th percentile used to represent the coarse fraction (50% and 84% of the sediment is finer than D50 and D84, respectively). So, for example, if D50=6.3 inches, then 50% of the particles in the sample are larger than 6.3 inches, and 50% are smaller.

Table 4-18. Model Simulation Results for Little Cottonwood Creek

Stream Location	Predicted Stream Flows (cfs)			Particle Sizes (in)	
	6-inch Flow Depth	Riffle for D50 Material	Riffle for D84 Material	D50	D84
Murray Hydroelectric Plant	4.55	0.08	0.84	6.3	14.2
Wasatch Resorts community	9.18	0.11	1.72	1.4	4.7
Temple Quarry	1.96	0.04	0.69	3.3	9.1
La Caille Restaurant	3.67	0.20	2.34	1.1	3.9
Upper Rails	15.01	0.19	3.01	1.9	4.3
Cobble Canyon Lane	4.80	0.31	3.63	0.9	3.9
Pepper Hill bridge	12.75	0.57	8.19	2.1	3.9
Royal Lane	2.12	0.12	1.37	2.0	4.3
Cottonwood Cove	7.27	0.39	5.31	1.4	3.2
Crestwood Park	6.06	0.45	4.01	1.1	2.7

Source: SLCO 2016

Field data collected included the channel dimensions ranging from 25 feet to 37 feet of wetted perimeter (flow area represented during a 1.5-year return period, or annual low flow event). Model simulation results predicted a low-flow wetted perimeter of 3 to 21 feet for a riffle section over D84 material, and 0.9 to 12 feet for a riffle section over D50 material. These results indicated that the decrease in wetted perimeter would result in a proportional decrease in water loss due to infiltration.

Taking account of the modeling simulation results and field observations, the County determined that the water loss during annual low-flow events could range between 2.4 and 4.5 cfs, while water loss during high-snowmelt events could range from 11 to 16 cfs for the same creek segment.

The County concluded that, to maintain a minimum stream flow and sustain a riparian community capable of providing buffering capacity for high-stream-flow events, the stream flow would need to exceed water loss estimates. Therefore, a minimum flow of about 3.23 cfs would be required at the hydroelectric plant reference site, D50 criteria (that is, 50% of stream bed materials with diameters of less than the designated size should not be covered by flowing water in riffle facets), which provides for 0.83 cfs of stream flow combined with about 2.4 cfs of flow to account for anticipated infiltration.

Summary

As a result of the 2009 Plan, the County conducted a site-specific evaluation of Little Cottonwood Creek to establish a minimum base flow quantity for a 25,000-foot segment of the stream that experiences perennial flow regimes that are interrupted or reduced as a result of water diversions. The loss of stream flows is associated with reduction and loss of riparian vegetation and aquatic habitat and increased risk of damage from high-flow events including bank erosion, infrastructure failures, and stream bed and bank instability. Some of this damage can be attributed to a lack of riparian vegetation and the flood flow buffering capacity and bank stabilization that vegetation provides.

To estimate minimum stream flows required to maintain riparian and aquatic habitat, varying soil conditions, natural flow regimes, and water diversions need to be considered. The County conducted a study to determine a minimum base flow for the segment of Little Cottonwood Creek using multiple methodologies including field flow measurements and observations during snowmelt runoff conditions in 2015, stream flow gage analysis and characterization of flow areas, and stream bed and bank materials.

The study area has two main stream bed and bank materials: sandy loam and sand. Stream flow losses through the segment as a result of infiltration are higher in areas where the sandy loam material is dominant than in areas where the sand material is dominant, and can be assumed to be proportional to stream flows and the wetted perimeter during the varying stream flow events.

Hydraulic computer modeling simulations for the segment of Little Cottonwood resulted in predictions of stream flows to meet minimum flow depth requirements. For one simulation, an estimated 50 cfs would be required to maintain a water depth of 12 inches. Other simulations resulted in flows ranging from 3.2 to 8.4 cfs to provide a stream riffle environment while accounting for stream flow losses due to infiltration.

The County's analysis, based on field measurements and model simulations, resulted in a conclusion that a stream flow of about 3.2 cfs would be adequate to maintain minimum flows through this segment of Little Cottonwood Creek in order to meet pool-to-pool connectivity goals and sustain riparian vegetation for low-flow conditions during the seasonally dry precipitation months of the summer.

Going forward, the County will investigate methods to obtain and maintain about 10 cfs, through this segment of Little Cottonwood Creek during the summer months. The analysis and methodology conducted on Little Cottonwood could be conducted on other perennial stream segments that exhibit reduced and interrupted flows to predict minimum flows restore and maintain watershed functions of habitat, water quality, hydrology, and social/recreation uses.

4.6 References

- [CVWRF] Central Valley Water Reclamation Facility
 2015 Email from Phil Heck, CVWRF, to Karen Nichols, HDR. November 13.
- [CWP] Center for Watershed Protection
 2007 National Pollutant Removal Performance Database, Version 3. September.
- [EPA] U.S. Environmental Protection Agency
 1999 Stormwater Technology Fact Sheet – Vegetated Swales. 832-F-99-006.
- [JVWCD] Jordan Valley Water Conservancy District
 2015a Personal communication between Alan Packard, JVWCD, and Steve Thurin, HDR. September 15, 2015.
 2015b Facilities. <https://jvwcd.org/about/facilities>. Accessed October 16, 2015.
- [Magna Water] Magna Water District
 2016 Telephone conversation between Steve Williams, Magna Water District, and Karen Nichols, HDR. January 11.
- [MWDSLS] Metropolitan Water District of Salt Lake and Sandy
 2014 40-Year Water Supply Plan. July.
- [NHDES] New Hampshire Department of Environmental Services
 2008 New Hampshire Stormwater Manual, Volume 2: Post-construction Best Management Practices, Selection, and Design. December.
- [SLCDPU] Salt Lake City Department of Public Utilities
 2014 Letter to Utah Division of Water Quality, Salt Lake City comments regarding the 2nd Change in Proposed Rule for Implementing Utah’s Nutrient Control Strategy. November 14.
 2016 Telephone conversation between Tom Ward, SLCDPU, and Karen Nichols, HDR. January 11.
- [SLCO] Salt Lake County
 2009 Salt Lake Countywide Water Quality Stewardship Plan.
 2014 2014 Stormwater Quality Technical Report. In participation with Utah Department of Transportation, Region 2. May.
 2016 Little Cottonwood Flow Study: An analysis of discharge required to keep perennial flow in Little Cottonwood Creek from the Wasatch Resorts Diversion Structure to Highland Drive.
- [SLCOHD] Salt Lake County Health Department
 2016 Email from Brandi Cordova, SLCOHD, to Marian Hubbard, Salt Lake County. January 27.

[SVWRF] South Valley Water Reclamation Facility

2016 Telephone conversation between Lee Rawlings, SVWRF, and Karen Nichols, HDR. January 11.

[UDWRe] Utah Division of Water Resources

2015 Water Conservation Program. <http://www.conservewater.utah.gov/why.html>. Accessed November 24, 2015.

[UDWRi] Utah Division of Water Rights

2015 Water Company Database. <http://www.waterrights.utah.gov/forms/waterCompanies.asp>. Accessed October 16, 2015.

[WisDOT] Wisconsin DOT

2007 Grass Swales: Gauging Their Ability to Remove Pollutants from Highway Stormwater Runoff. June.

This page is intentionally blank.

5.0 IMPLEMENTATION

This chapter focuses on the implementation and evaluation of this 2015 Plan. It compiles information about primary watershed stressors and specific management practices that can be used to address those stressors and describes monitoring of the implemented practices to determine success and adaptive management.

This chapter updates the guiding policies and specific implementation recommendations for going forward with planning for water-quality related management decisions. It describes public and stakeholder involvement, education, and information for coordinating and constructing designs aimed at the betterment of water quality and watershed functions.

Finally, this chapter outlines the procedures for approving, updating, and amending the 2015 Plan.

5.1 Summary of 2009 Plan

This chapter combines elements of three chapters from the 2009 Plan: Chapter 5.0 Atlas of Opportunities, Chapter 6.0 Implementation, and Chapter 7.0 Monitoring (SLCO 2009). Summary of the discussion and recommendations from these 2009 Plan chapters is incorporated in the following sections.

5.2 Watershed Stressors

The 2009 Plan Atlas of Opportunities (SLCO 2009, Chapter 5) reviews sub-watershed-specific information and identifies major watershed function stressors for each sub-watershed. Identifying the major stressors enabled the County to make sub-watershed-specific recommendations that focus on specific stressors. The watershed functions (water quality, habitat, hydrology, and social/recreation) remain consistent with this update. Watershed stressors and best watershed management practices identified in the 2009 Plan are carried forward with this updated plan.

The 2009 Plan identified the top three watershed stressors as:

1. Lack of developed recreation—recreational opportunities and access to watershed resources can lead to an increased sense of place and stewardship about the local environment.
2. Lack of stream corridor protection
3. New development and redevelopment pressures.

These three general categories of stressors were further defined by watershed function. In addition to the 2009 Plan watershed stressors, this plan has identified new stressors, which are shown in Table 5.1 in *italics*.

Table 5-1. Watershed Function Stressors

Watershed Function: Water Quality		
<ul style="list-style-type: none"> Point sources Urban stormwater runoff Thermal energy (water temperature discharges) Nutrients Low DO levels 	<ul style="list-style-type: none"> Chemicals (metals, inorganics, organics, radiological) Siltation Physical characteristics Pathogens (<i>specifically E. coli</i>) 	<ul style="list-style-type: none"> <i>Organic matter</i> <i>Increased number of streams not meeting beneficial uses</i> <i>Nonpoint sources (specifically on-site wastewater [septic tank] systems)</i> <i>Lack of macroinvertebrate populations and diversity</i> <i>Increased stream temperatures in lower watersheds</i>
Watershed Function: Hydrology		
<ul style="list-style-type: none"> Development in floodplain Lack of floodplain Lack of floodplain connectivity Increased impervious areas leading to lack of groundwater recharge 	<ul style="list-style-type: none"> Bank and channel instability Channelization Maintenance activities Engineered channels (culverts and pipes used to convey streams underground) 	<ul style="list-style-type: none"> Increased impervious areas leading to management of flood flows and lack of natural stream hydrology <i>Increased pressure on water resources as a result of increased energy requirements</i> <i>Potential increase in stormwater runoff volumes as a result of changes in precipitation patterns from climate change</i>
Watershed Function: Habitat		
<ul style="list-style-type: none"> Restricted fish passage Limited habitat features Limited riparian habitat diversity Limited and lack of stream flow 	<ul style="list-style-type: none"> Limited and lack of riparian buffer width Limited stream shading <i>Increased stream temperatures as a result of increased temperatures from climate change</i> 	<ul style="list-style-type: none"> <i>Vulnerability of riparian vegetation and wetland areas as a result of increased temperature and change in precipitation from climate change</i> <i>Lack of water depth (as measured at a stream's lowest point)</i>
Watershed Function: Social/Recreation		
<ul style="list-style-type: none"> Lack of public stream corridor Lack of recreational facilities Lack of restrooms 	<ul style="list-style-type: none"> Lack of accessible recreation Lack of resource connectivity Resource compatibility conflicts Visual environment that is not aesthetically pleasing 	<ul style="list-style-type: none"> <i>Increased energy requirements to deliver and treat water</i> <i>Reduction of open space</i> <i>Environmental justice populations of minorities</i>

Items shown in *italics* are new stressors identified in this 2015 Plan

5.3 Sub-watershed Characteristics

This section presents an updated summary table that summarizes the updated data describing the conditions of the four watershed functions in each sub-watershed. Table 5-2 shows, by sub-watershed, general data and specific stressor data, including:

- *General sub-watershed data* – name, area, and length of main waterbody segment. Some of these data have changed from the 2009 Plan. For example, the west-side watersheds were divided into upper and lower sub-watersheds, and more accurate survey data are available to determine the stream lengths.
- *Water quality* watershed function – percentage of stream within the sub-watershed that is on the CWA Section 303(d) impaired waterbodies 2014 list and percent change in impervious surface area.
- *Hydrology* watershed function– percentage of stream length in watershed with reduced or interrupted flow. These data are brought forward from the 2009 Plan and represent stream lengths that have flows diverted from them, resulting in a reduction of flow or an interruption in flow in the main stream channel.

- *Habitat* watershed function – indicated by an overall habitat index, which is determined by averaging indices for stream channel sub-group parameters and riparian corridor sub-group parameters. This index is based on data collected by the County during 2009–2014. Some sub-watersheds have multiple sites that were evaluated, and therefore the habitat index for each site is presented.
- *Social and recreational services* – indicated by loss of open space, presence of environmental justice populations, and 2011–2040 forecasted change in population.

In Table 5-2, the stressors that are more likely to affect a specific watershed function or represent a degraded watershed function characteristic are colored a darker shade of red, while stressors that are less likely to affect a specific watershed function or represent an acceptable watershed function characteristic are colored a lighter shade of red. For visual purposes, the stressors are divided into three categories representing low-, medium-, and high-risk to watershed functions. For this reason, the colored cells in Table 5-2 might not exactly match up with the maps presented in Chapter 3.

Although many of the stressors can affect more than one watershed function, they are placed in a single category for the sake of presentation. For example, changes in impervious surface area can affect water quality, hydrology, habitat, and social/recreation functions. The four functions studied in this plan are not mutually exclusive.

Table 5-2 is presented in alphabetical order by sub-watershed. This summary table is meant to be used in combination with the sub-watershed fact sheets that were presented in the 2009 Plan to review existing conditions and projected changes in the sub-watersheds, based on the analyses conducted.

Table 5-2. Sub-watershed Characteristics and Conditions - 2015 Plan Update

Sub-watershed	Area (acres)	Length of Stream Main Stem (miles)	Water Quality		Hydrology	Habitat			Social and Recreational Services		
			Percent of Length Listed as Impaired Waterbodies in Sub-watershed ^a	Percent Change in Impervious Surface Area ^b	Percent of Stream in Watershed with Reduced or Interrupted Flow ^c	Habitat Index ^d			Percent Change in Open Space ^b	Environmental Justice Populations (that exceed county averages) ^e	2011 - 2040 Forecasted Change in Pop. ^f
Upper Barney's Creek (UBN) ^g	12,157	4.3	0	9	0	NA			-25	Ethnic minority	50,354
Lower Barney's Creek (LBN) ^g	20,245	4.3	0	7	0	NA			-73	Ethnic minority	52,844
Upper Big Cottonwood Creek (UBC)	31,954	14.5	100	0	18	59	47	0	0	None	3
Lower Big Cottonwood Creek (LBC)	20,249	10.4	100	2	100	48	26	78	-1	None	5,267
Upper Bingham Creek (UBG) ^g	12,105	1.1	100	0	100	NA			-4	Racial minority	6,883
Lower Bingham Creek (LBG) ^g	13,279	8.9	100	23	100	NA			-67	None	86,947
Upper City Creek (UCC)	11,168	11.2	62	0	35	NA			0	None	-37
Lower City Creek (LCC)	4,621	2.9	0	0	100	59			0	Poverty	1,855
Corner Canyon Creek (CY)	9,358	8.2	0	3	69	50			-12	None	4,107
Decker Lake (DL)	6,180	NA	0	0	NA	NA			-37	Poverty, Racial minority, Ethnic minority	679
Upper Dry Creek (UDC)	3,881	3.5	0	0	10	NA			0	None	-6
Lower Dry Creek (LDC)	8,559	9.1	0	1	100	NA			-15	None	7,925
Upper Emigration Creek (UEM)	11,635	9.5	100	0	0	77	83	56	0	None	-3
Lower Emigration Creek (LEM)	3,742	5.4	100	0	88	86			0	None	-632

5.0 Implementation

Table 5-2. Sub-watershed Characteristics and Conditions - 2015 Plan Update

Sub-watershed	Area (acres)	Length of Stream Main Stem (miles)	Water Quality		Hydrology	Habitat			Social and Recreational Services		
			Percent of Length Listed as Impaired Waterbodies in Sub-watershed ^a	Percent Change in Impervious Surface Area ^b	Percent of Stream in Watershed with Reduced or Interrupted Flow ^c	Habitat Index ^d			Percent Change in Open Space ^b	Environmental Justice Populations (that exceed county averages) ^e	2011 - 2040 Forecasted Change in Pop. ^f
Great Salt Lake (GSL)	135,826	7.0	50	1	61	NA			-2	Poverty, Racial minority, Ethnic minority	52,327
Coon Creek (CN)	14,444	18.5	0	-10	0	NA			-2	Ethnic minority	3,829
Jordan River Corridor (JRC)	35,298	45.2	100	2	72.2	NA			-31	Poverty, racial minority, ethnic minority	61,684
Upper Little Cottonwood Creek (ULC)	17,386	12.0	100	0	21	NA			0	None	-16
Lower Little Cottonwood Creek (LLC)	8,140	10.6	100	0	100	55	58		0	None	2,949
Upper Midas/Butterfield Creek (UMB) ^g	12,491	4.9	100	6	0	85			-11	None	3,237
Lower Midas/Butterfield Creek (LMB) ^g	16,080	18.8	100	21	13	NA			-85	None	89,278
Upper Mill Creek (UMC)	13,915	11.9	1	0	0	74	80		0	None	-1
						74	88				
Lower Mill Creek (LMC)	9,730	8.4	100	0	92	61	51		-16	Racial minority	1,559
Upper Parley's Creek (UPC)	33,256	25.9	57	0	37	90	67	83	0	None	-1
						83	77	75			
						50	86	63			
Lower Parley's Creek (LPC)	4,112	5.7	100	0	100	71	79		0	None	679
						85	76				
Upper Red Butte (URB)	5,403	4.7	100	0	30	87			0	None	-2
Lower Red Butte (LRB)	1,652	3.8	15	11	100	60	46		-2	None	-239
Upper Rose Creek (URC) ^g	8,810	3.6	100	6	50	61			-8	None	10,045

Table 5-2. Sub-watershed Characteristics and Conditions - 2015 Plan Update

Sub-watershed	Area (acres)	Length of Stream Main Stem (miles)	Water Quality		Hydrology	Habitat	Social and Recreational Services		
			Percent of Length Listed as Impaired Waterbodies in Sub-watershed ^a	Percent Change in Impervious Surface Area ^b	Percent of Stream in Watershed with Reduced or Interrupted Flow ^c	Habitat Index ^d	Percent Change in Open Space ^b	Environmental Justice Populations (that exceed county averages) ^e	2011 - 2040 Forecasted Change in Pop. ^f
Lower Rose Creek (LRC) ^g	9,382	7.6	100	0	100	NA	-19	None	14,181
Upper Willow Creek (UWC)	4,454	4.2	0	0	0	NA	0	None	-1
Lower Willow Creek (LWC)	6,001	11.9	0	3	91	NA	-17	None	3,603
Wood and Beef Hollow (WBH) ^g	9,765	12.3	0	No data	0	NA	No data	None	114

^a Designated by the State of Utah as impaired, in 2014, pursuant to Section 303(d) of the Clean Water Act.

^b Based on change in land uses reported by WFRC (2014).

^c Data shown are carried over from the 2009 Plan with estimations made for the newly designated sub-watersheds.

^d Habitat indices are not available for all sub-watersheds; sub-watersheds without data are indicated with NA (not available). Multiple data points within a sub-watershed can have different indices.

^e Components are poverty (countywide rate of 12.7% of population), racial minorities (countywide rate of 15.4% of population); and ethnic minorities (Hispanic or Latino/Latina; countywide rate of 17.2%).

^f Data from Table 3-8, which includes estimations made for the newly designated sub-watersheds.

^g Newly designated sub-watershed for this 2015 Plan

5.0 Implementation

5.4 Watershed Management Practices

Watershed management practices are types of measures implemented to achieve a specific goal in watershed health. These best management practices can be designed to address specific watershed stressors, and can be used individually or in combination to achieve the desired goal. *Structural practices* are built facilities that typically provide some degree of treatment, and *nonstructural practices* usually involve changes in activities or behavior and focus on prevention, such as controlling pollutants at the source.

The 2009 Plan identified stressors and structural and nonstructural management practices that are generally associated with each of the four watershed functions (SLCO 2009, Tables 5.35.6). These practices are still applicable to reduce or remove the effects of watershed stressors, and are shown in Table 5-3 below along with a number of additional watershed management practices (in *italics*).

Table 5-3. Structural and Nonstructural Watershed Management Practices

Structural		Nonstructural	
Watershed Function: Water Quality			
<ul style="list-style-type: none"> Bioengineered bank stabilization Channel restoration and enhancement <i>Stormwater BMPs</i> <i>Erosion control and sediment source control BMPs</i> <i>Green roofs</i> 	<ul style="list-style-type: none"> Bioretention facilities Manufactured treatment systems Sand filters Sediment basins Trash racks 	<ul style="list-style-type: none"> Facility maintenance Pet waste management programs Street sweeping Section 401 permitting <i>Antidegradation requirements</i> <i>Watershed protection strategies</i> <i>Public education regarding pollutant source controls</i> 	<ul style="list-style-type: none"> <i>Low-impact design and LEED development</i> <i>Impervious surface area limits</i> <i>Minimize soil and vegetation disturbance during construction</i> <i>Source controls (pollution prevention activities)</i> <i>On-site wastewater (septic tank) management strategies</i>
Watershed Function: Hydrology			
<ul style="list-style-type: none"> Bioengineered aquatic habitat structures Infiltration basins Floodplain reconnection Rain water harvesting <i>Energy efficient technologies</i> <i>Water efficient technologies</i> <i>Green infrastructure</i> <i>Increase secondary water and reuse water use</i> 	<ul style="list-style-type: none"> Canal water diversions Modifications Minimize directly connected impervious areas Vegetated swales <i>Stormwater ponds and retrofit for water quality improvement</i> <i>Instream flow augmentation during low-flow or no-flow conditions</i> 	<ul style="list-style-type: none"> Water right acquisition <i>Incorporate natural waterways in site development</i> <i>Protect floodplain from development</i> <i>Public education of water and energy nexus</i> <i>Stream capacity vulnerability assessment and planning for potential changes in runoff as a result of climate change</i> 	<ul style="list-style-type: none"> <i>Reallocation of water rights</i> <i>Changes to beneficial use of water definition</i> <i>Site stormwater retention (volume) ordinance</i> <i>Water conservation practices</i>
Watershed Function: Habitat			
<ul style="list-style-type: none"> Increased riparian vegetation Constructed wetlands Wetland restoration and enhancement Grade-control structures 	<ul style="list-style-type: none"> <i>Native-fish stocking</i> <i>Exotic-fish management</i> <i>Revetments</i> <i>Stream daylighting</i> <i>Wetland protection</i> <i>Removal of fish barriers</i> 	<ul style="list-style-type: none"> <i>Riparian buffer protection ordinances</i> <i>Sensitive-area protection</i> <i>Urban forestry</i> 	<ul style="list-style-type: none"> <i>Land acquisition for habitat preservation</i> <i>Design of riparian restoration to withstand climate variability</i>
Watershed Function: Social/Recreation			
<ul style="list-style-type: none"> Local and regional trail networks Interpretive opportunities 	<ul style="list-style-type: none"> <i>Implement projects to remove pollutants to meet beneficial uses</i> 	<ul style="list-style-type: none"> <i>Community action groups</i> <i>Education materials and outreach</i> <i>Volunteer programs</i> <i>Energy-optimization practices</i> <i>Capacity building</i> 	<ul style="list-style-type: none"> <i>Implement education and monitoring to increase knowledge of water quality improvement plans to meet beneficial uses</i> <i>Evaluate project effects (beneficial and adverse) on environmental justice populations</i>

5.5 Guiding Policies

The 2009 Plan identified 10 guiding policies to assist with water quality management decisions for developing and implementing projects. The 2009 Plan guiding policies are revised for this 2015 Plan and will be used to help the County identify and review proposed projects and/or management strategies that focus on preserving and improving watershed functions (water quality, habitat, hydrology, and social/recreational uses).

The eight guiding policies for this 2015 Plan include:

1. Improve and/or protect physical, chemical, and biological integrity of surface water quality and watershed health.
2. Consistency with strategies identified in current federal (area-wide water quality management and watershed planning guidelines), state (point- and nonpoint-source and basin plans), and local (general and master plans, stormwater management plans, and pollution-prevention plans) planning documents.
3. Incorporate and address concurrent regulations, such as stormwater, total maximum daily load (TMDL) recommendations, flood control, and water quality standards that lead to the preservation or restoration of beneficial uses to all waterbodies.
4. Coordinate with the public and partners to promote capacity building.
5. Provide for meaningful public involvement and promote awareness in the planning process.
6. Implement strategies that are based on solid scientific understanding and are technically feasible.
7. Plan and implement management strategies and improvement projects to be financially, ecologically, and socially sustainable.
8. Incorporate and plan for long-term maintenance and monitoring of strategies and improvement projects.

5.6 Priority Implementation Recommendations

The following priority implementation recommendations are based on continuing with tasks identified in the 2009 Plan and new efforts based on information and analysis presented in the 2015 Plan. Although there are 14 priority recommendations listed below, opportunities could arise to address preserving and improving watershed functions that might not apply to these specific tasks. In these cases, the County would evaluate the opportunities on a case-by-case basis.

When moving forward with implementing the priority recommendations, water quality improvement projects should accommodate various stakeholder and public concerns and use existing resources (for example, staff and funds). These recommendations will require new policy and ordinances as well as substantial funding for County resources to prepare studies and planning documents and to design and construct individual projects.

The following 14 implementation recommendations are given priority for this 2015 Plan:

1. Encourage the adoption of land-development and resource-management strategies that focus on low-impact design criteria, use of green infrastructure, and use of energy and water resource conservation technologies.
2. Continue to maintain and update this Integrated Watershed Plan to evaluate proposed point and nonpoint source discharges, regulatory requirements, and watershed planning elements as necessary.
3. Participate in the state water quality standards, beneficial use, and impaired waterbody rule-making processes to preserve and enhance watershed and area-wide water quality.
4. Continue to implement the Public and Stakeholder Involvement Plan component of this integrated watershed plan (discussed in more detail in the following section) for vesting partners and the public in water quality management practices and improvement projects.
5. Expand water quality and stream flow data collection and make the data available, via website, to interested parties.
6. Maintain and update Stream Function Index (SFI) with the collection of riparian, stream channel, flood conveyance, stream stability, social amenities (trails and nodes), and aesthetic parameters.
7. Prepare sub-watershed planning and implementation strategies in coordination with municipal and agency partners to support preserving, restoring, and enhancing water quality and watershed functions.
8. Provide assistance, coordination, facilitation, and/or oversight for capacity building, and water quality improvement project planning and implementation.
9. Evaluate areas along the Jordan River and other countywide streams for stream restoration, bank stabilization, and water quality, riparian, and aquatic habitat-improvement projects.
10. Consider opportunities to reduce water and energy demands through ecosystem and water resource management, watershed protection, and restoration investments. These opportunities should focus on minimizing treatment costs, providing flood control, and maximizing recreational opportunities.
11. Consider potential vulnerabilities of watershed preservation and water quality restoration, enhancement, and maintenance projects as a result of changes in temperature, precipitation, and runoff anticipated from climate change.
12. Evaluate opportunities to provide continuous instream flows for stream segments that experience reduced or interrupted flow regimes in order to restore and enhance aquatic and riparian habitat, water quality, and hydrologic conveyance functions.
13. Evaluate funding and partnering opportunities to construct and maintain a debris basin retrofit pilot project in Spencer's Pond in order to remove organic matter from low-flow conditions, an activity that will facilitate implementing the Jordan River TMDL. Evaluate other debris basin ponds for similar low-flow pollutant-removal retrofit opportunities.
14. Provide for monitoring and maintenance of implemented strategies and projects.

Public and Stakeholder Involvement Plan

Salt Lake County's Watershed Planning and Restoration Program engages the public and stakeholders in a variety of ways, and coordination with these groups is focused on capacity building for specific issues within the watershed. Capacity building, in this context, is defined as the process of developing and strengthening the skills, instincts, abilities, processes, and resources that agencies, organizations, and communities need to consider when implementing area-wide water quality improvement strategies and projects. Using this approach, Salt Lake County intends to work cooperatively with local partners and state agencies to implement a plan that takes a wider view than just the County's jurisdictional area.

Review of Existing Efforts

Existing public and stakeholder involvement efforts are discussed below. Recent and ongoing projects are also summarized in Chapter 2.0, Six Year Evaluation (see Tables 2-1 and 2-2).

Publications. The Watershed Planning and Restoration Program publishes *Watershed Watch*, a twice-annual newsletter that provides information about water quality and watershed protection issues in the Jordan River basin, upcoming events, and how residents can get involved in the County's watershed-focused activities and programs. In 2014, the County published the first edition of its *Stream Care Guide: A Handbook for Residents of Salt Lake County*. This guide provides information about how residents can care for local streams to prevent or minimize erosion, avoid flood losses, preserve water quality, and contribute to the survival of fish and wildlife. In early 2015, the guide was mailed to owners of residential property that is adjacent to streams in Salt Lake County. The guide is available electronically (online at slco.org/watershed/) and in hard copy from the Watershed Planning and Restoration Program. The County intends to update and reprint future editions of the Stream Care Guide, as needed.

Annual Conference. The County sponsors an annual Watershed Symposium, a two-day conference that encourages a comprehensive review of the current state of the watershed while creating learning and networking opportunities for a broad array of stakeholders. Sessions are dedicated to bringing together individuals from a wide range of backgrounds, including science, engineering, business, public policy, education, and community groups. The Watershed Symposium is free and open to all. Typical attendees include area residents; university students and staff; personnel from state, federal, tribal, and municipal governments; the private sector; environmental groups; and local watershed organizations.

Public Opinion Surveys. In addition to providing water quality and watershed-focused information *to* the public, the County also regularly seeks information *from* the public through periodic telephone surveys. These surveys focus on attitudes and knowledge about water quality and watershed health. Thus far, the County has commissioned surveys in 2007, 2010, and 2015, and intends to continue periodic surveys to gauge how and whether residents' attitudes and knowledge about watersheds and water quality change over time. This type of information highlights concerns that can help Salt Lake County and its partners focus on the water quality issues that matter the most to residents' quality of life. The final reports for all of the public opinion surveys can be found online at <http://www.slco.org/watershed/>. Most recently, the findings from the 2015 survey revealed a public that is heavily engaged with the outdoors and

places a high priority on clean water. Respondents indicated support for more action by the County to promote watershed health, and a willingness in the public to pay more for water protection (SLCO 2015). For a detailed discussion of the 2015 survey findings, see Section 3.3, Public Opinion about the County’s Watersheds.

Stakeholders. The County currently coordinates with stakeholders, including federal, state, and local agencies and municipalities, during the planning, design, and implementation of water quality improvement projects. Working with partner agencies and municipalities to identify funding, obtain access, and plan and design projects to meet multiple watershed objectives is critical to successful project implementation. Recent projects discussed in Chapter 2.0, Six-Year Evaluation, involved coordination with multiple federal partners, including EPA, the U.S. Army Corps of Engineers, the U.S. Fish and Wildlife Service, the U.S. Forest Service, the Federal Emergency Management Agency, and the Natural Resources Conservation Service; state agencies including the Utah Divisions of Forestry, Fire and State Lands, Water Resources, Water Quality, Wildlife Resources, and Water Rights; and other Salt Lake County divisions and programs including the Stormwater Coalition, Health Department, Township Services, Parks and Recreation, and Open Space.

The County leads and participates as a member of the Jordan River Watershed Council (JRWC) and uses that platform to facilitate discussion of the water quality goals and objectives of local stakeholders. Other members of the JRWC include federal, state, and municipal government representatives and representatives of public and special interest stakeholder groups. By means of open communication, collaboration, and education among all interested parties, the JRWC seeks to:

- Establish leadership of sustainable, long-term river, stream, and groundwater stewardship.
- Provide a centralized arena where watershed concerns can be addressed.
- Promote public involvement in the management of our local watershed.

Additionally, the County participates on the Jordan River Commission Executive Board and Technical Advisory Team, Utah Watershed Coordinating Council, Utah Water Quality Task Force, the Wasatch Legacy Partnership, and Mountain Accord Executive Committee and Environmental Systems Group.

Future Public and Stakeholder Involvement, Education, and Information Activities

To meet the guiding policies of promoting capacity building, promoting awareness in the watershed, and supporting water quality improvement planning processes, the County will continue with leadership, coordination, and participation in the following activities, as listed in Table 5-4.

Table 5-4. Public and Stakeholder Involvement Plan

Activity	Frequency
Continue to coordinate and sponsor the annual Salt Lake County Watershed Symposium for the public and stakeholder groups.	Once per year
Attend and distribute watershed and water quality information at tabling events at public and governmental events, and other potential venues.	As scheduled
Prepare and distribute the <i>Watershed Watch</i> newsletter.	Twice per year
Update and maintain a website with programmatic information, studies, projects, and collected data.	Ongoing
Continue leading and participating in the Jordan River Watershed Council (JRWC).	Four times per year
Distribution of partnering, funding, watershed planning, and water-quality project implementation information to interested parties via website, social media, and the JRWC email listserv.	Ongoing
Participate in relevant advisory and committee meetings, including: Utah Watershed Coordinating Council, Jordan River Commission, Jordan River–Farmington Bay Water Quality Council, Salt Lake County Stormwater Coalition, Mountain Accord, Mountain Planning District, Wasatch Legacy Partnership, Salt Lake County Health Department, and Utah Water Quality Task Force.	As scheduled
Evaluate environmental justice populations for outreach, information, and educational efforts during project implementation.	As required
Continue to conduct a public survey for watershed and water quality awareness.	Once every 5 years
Continue to coordinate with stakeholders and the public during the preparation and updating of this Integrated Watershed Plan.	Once every 10 years or as needed
Update and distribute subsequent editions of the <i>Stream Care Guide</i> .	As required

5.7 Monitoring

Monitoring water quality, watershed function, and stream function parameters provides the scientific basis for determining the success of or the need for adaptive management. Monitoring data can be used to evaluate existing conditions, calculate pollutant loads, and develop water quality improvement projects to mitigate adverse water quality conditions or prevent further degradation of watershed functions.

Existing Monitoring Efforts

Numerous federal, state, and local agencies and municipalities collect water quality and watershed-related data throughout the county. These data are used to guide management strategies and implement projects that focus on preserving, protecting, and enhancing water quality, watershed functions, and stream functions.

Ongoing data collection efforts are summarized by watershed function in Table 5-5.

Table 5-5. Entities Conducting Water Quality and Watershed Data Collection

Watershed Function: Water Quality		
<ul style="list-style-type: none"> • U.S. Forest Service • Utah Division of Water Quality • Utah Department of Transportation, Stormwater Compliance 	<ul style="list-style-type: none"> • Salt Lake County Watershed Planning & Restoration • Salt Lake County Stormwater Program • Jordan River and Farmington Bay Water Quality Council • Central Valley Water Reclamation Facility • Magna Water District 	<ul style="list-style-type: none"> • Salt Lake City Public Utilities • Sandy City Public Utilities • Metropolitan District of Sandy and Salt Lake • Jordan Valley Water Conservancy District • South Valley Water Reclamation Facility • Jordan Basin Water Reclamation Facility • Industrial point source and stormwater discharge permittees
Watershed Function: Hydrology		
<ul style="list-style-type: none"> • U.S. Forest Service • U.S. Geological Survey • Natural Resources Conservation Service • Utah Division of Water Resources • Utah Division of Homeland Security • Utah Association of Conservation Districts 	<ul style="list-style-type: none"> • Salt Lake County Watershed Planning & Restoration • Salt Lake County Flood Control Engineering • Salt Lake City Dept. of Public Utilities 	<ul style="list-style-type: none"> • Local municipal stormwater and flood-management divisions
Watershed Function: Habitat		
<ul style="list-style-type: none"> • U.S. Forest Service • Utah Division of Wildlife Resources 	<ul style="list-style-type: none"> • Salt Lake County Watershed Planning and Restoration 	
Watershed Function: Social/Recreation		
<ul style="list-style-type: none"> • U.S. Forest Service • Utah Division of Forestry, Fire and State Lands • Utah Division of Parks and Recreation 	<ul style="list-style-type: none"> • Salt Lake County Watershed Planning & Restoration • Salt Lake County Parks & Recreation, Open Space 	<ul style="list-style-type: none"> • Local municipal parks, recreation, and open space divisions

Future Monitoring Efforts

In addition to ongoing water quality and watershed function monitoring efforts, several entities develop and implement specific monitoring plans. These plans are used to investigate and evaluate program-specific elements (for example, lower Jordan River TMDL continuous water quality monitoring) or project-specific elements (such as pollutant load reductions).

Salt Lake County is partnering with the Mountain Accord effort to create an environmental dashboard (Dashboard). The multi-jurisdictional Mountain Accord effort is a public process committed to preserving the mountains for future generations, to addressing immediate concerns, and to realizing a long-term vision for the future. The Dashboard compiles data currently collected throughout the Central Wasatch Mountains in a way that provides a picture of the complete health of the mountain range, as well as a mechanism for measuring the health moving forward. The Dashboard is a tool for decision makers to track the Central Wasatch's environmental health and evaluate impacts in future planning discussions. It is the intention of the Mountain Accord that the Dashboard is a legacy project and will be updated on a regular basis. The Dashboard is beginning development in early 2016 and will add to the monitoring of ecosystem health.

The County will continue to gather ecological data by monitoring watershed function parameters, as listed in Table 5-6. The data collection will be consistent with the methods and procedures identified during the development of the Stream Function Index and Ecosystem Health Index (SLCO 2010). The County will work with partners that can add or replace specific parameters to support focused studies.

Table 5-6. Watershed Function Parameters

Watershed Function: Water Quality		
<ul style="list-style-type: none"> • 303 (d) list of impaired waterbodies 	<ul style="list-style-type: none"> • Macroinvertebrates 	<ul style="list-style-type: none"> • Temperature • Total dissolved solids • Total phosphorous • Dissolved oxygen • Bacteria (<i>E. coli</i>) • Turbidity
Watershed Function: Hydrology		
<ul style="list-style-type: none"> • Stream flow 	<ul style="list-style-type: none"> • Floodplain development • Floodplain connectivity 	<ul style="list-style-type: none"> • Bank stability • Hydraulic modifications • Flow diversions
Watershed Function: Habitat		
<ul style="list-style-type: none"> • Stream channel characteristics: pool/riffle, water depth, fish passage, aquatic habitat structures, shading, boulders 	<ul style="list-style-type: none"> • Riparian corridor: width and plant community type 	<ul style="list-style-type: none"> • Stream bed profile and width
Watershed Function: Social/Recreation Uses		
<ul style="list-style-type: none"> • Aesthetics 	<ul style="list-style-type: none"> • Recreation nodes: location, parking, accessibility, restrooms, resource connectivity 	<ul style="list-style-type: none"> • Recreation trails: corridor, connectivity, and resource compatibility

The watershed functions parameters listed above in Table 5-6 generally reflect the biological, physical, and chemical characteristics and conditions of streams. The addition of other parameters that can be associated with watershed functions, as described in the 2009 Plan, could include groundwater recharge zones; headwater areas; wetland mapping for soils, vegetation, and

hydrology; stream flow regime characteristics; stream setback or buffer areas; and stream channel bed and bank stability.

5.8 Procedural

The area-wide water quality and watershed planning document, as represented by this 2015 Plan, is considered to be a result of a dynamic planning process. The County expects and anticipates adaptive management policies and procedures through the implementation of this 2015 Plan and future plans. This section reviews the processes for plan approval, scheduled updates, and amendments.

This 2015 Plan is scheduled to be updated every 10 years. The next update will incorporate the most recent population and land use data and will address current TMDL recommendations and 303(d) listings. Additionally, it is anticipated that the continued collection and analysis of water quality, habitat, hydrological and social data will allow Salt Lake County and its partners to monitor changes to the watershed with each update.

Plan Approval Process

The County intends that this 2015 Plan is submitted for a Salt Lake County Council resolution of support and approval from the Utah governor and EPA, consistent with the approvals that were received for the 2009 Plan.

This process applies to future plan updates, as well as plan amendments:

1. The 2015 Plan is submitted to the Salt Lake County Council for a resolution of support of the policies and recommendations in the plan.
2. With the County Council resolution, the 2015 Plan is submitted to the Governor of Utah for approval as in accordance with Sections 208(b)(1)(a) and 208(b)(3) of the federal Clean Water Act, and as an update to the existing plan.
3. Upon approving the 2015 Plan, the governor submits it to the Environmental Protection Agency, Region VIII (EPA) for approval as consistent with the elements required by the Clean Water Act and 40 CFR 130.6(c).

Summary of 2009 Plan Approval

The Salt Lake County Council passed a resolution supporting the policies and recommendations in the 2009 Plan (SLCO 2008). The resolution recognized the 2009 Plan as the new area-wide water quality management plan, promoted continued water quality planning efforts, and urged citizens of the county to participate in water quality planning and enhancement activities.

With County Council resolution, the 2009 Plan was submitted to the then-governor of Utah, Jon M. Huntsman, Jr., for approval. The governor approved the 2009 Plan to be in accordance with Sections 208(b)(1)(a) and 208(b)(3) of the federal Clean Water Act as an update of the 1978 Salt Lake County Area-Wide Water Quality Management Plan and submitted the document to EPA for approval (Huntsman 2009).

EPA approved the 2009 Plan as consistent with the elements required by the Clean Water Act and 40 CFR 130.6(c) (EPA 2010). The EPA approval letter also requested that the County incorporate changes and new information in the next scheduled update. The requested information is listed below along with the sections in this 2015 Plan where the information is provided.

- **Jordan River TMDL reductions** – Section 3.1, General Watershed Information Impaired Waterbodies
- **Use of 2010 Census data** – Section 3.2, Population and Land Use
- **New plans for water supply and reuse** – Section 4.2, Water Supply, and Section 4.3, Municipal Wastewater Discharges
- **Utah Division of Water Quality nutrient criteria** – Section 4.3, Municipal Wastewater Discharges
- **Data from the new Jordan Basin Wastewater Treatment Plant** – Section 4.3, Municipal Wastewater Discharges
- **Evaluation of Jordan River impacts to the Great Salt Lake and associated wetlands** – Section 3.1, General Watershed Information, Beneficial Uses, and Impaired Waterbodies
- **Consideration of the most sensitive designated uses in downstream water and identification of necessary upstream water quality controls that might be needed to protect these waters** – Section 3.1, General Watershed Information, Section 4.4, Nonpoint-Source Pollution, and Section 4.5, Pilot Studies

Plan Update Process

The 2015 Plan is considered to be the result of a dynamic, adaptive management planning process, and will be updated every 10 years. This timing reflects a change from the 2009 Plan, which called for a six-year update cycle (SLCO 2009, Section 6.5). An extended update cycle recognizes that the complexity, participation, and funding required to update this integrated watershed plan may require greater time. Certain situations, however, may trigger a plan update *sooner* than 10 years, such as changes to water quality regulatory requirements or programmatic changes to a TMDL.

The next update is scheduled for year 2025, and will consider and incorporate the following elements:

- 2015 Plan review and project implementation evaluation
- Current population and land-use analysis to identify changes that could affect water quality
- Water quality regulatory changes in rules, standards, beneficial uses, and impaired waterbody listings
- Collection and analysis of water quality and stream function data

- Watershed and water quality planning elements including pollutant loading reduction, point- and nonpoint-source discharges, instream flows, water supply, water treatment stormwater, and other pertinent topics
- Public review and comment on the draft plan
- Stakeholder participation, kickoff meeting, plan review, and comment
- Approval process through county, state, federal authorities

Plan Amendment Process

As discussed in the 2009 Plan, this 2015 Plan may require an amendment between scheduled plan updates, in order to evaluate proposed actions that affect area-wide water quality planning. The plan amendment process identified in the 2009 Plan is carried forward with this updated plan (SLCO 2009, Section 6.5).

The 2009 Plan includes detailed information about the plan amendment process based on stakeholder workshops, CWA 208 requirements, and watershed planning guidelines. Key elements identified in the 2009 Plan that the County could consider for incorporation into the plan amendment process include:

- Regional water quality and water resource planning and coordination
- Transparent environmental and public process during the planning of new point- and nonpoint-source discharges
- Sustainable design of water supply, treatment, and stormwater facilities
- Planning and permitting requirements for new point- and nonpoint-source discharges

The 2009 Plan also outlined amendment costs, public involvement, environmental considerations, and approval authorities in the amendment process.

For example, the plan may need to be amended if local jurisdictions make significant changes in planned land uses and the changes could affect things such as imperviousness of large areas or how local creeks might be managed. The plan would also be amended as a result of new point-source or nonpoint-source discharges associated with wastewater treatment facilities or other significant new discharges or regional wastewater treatment planning.

If a new discharge project planning requires this 2015 Plan to be amended, the County would follow the planning and permitting process illustrated in Figure 5-1. This process was developed during the 2009 Plan update and considered to be current. The role of a plan amendment is to evaluate a proposed project for area-wide water quality and watershed impacts and provide regional information to support the state and local permitting processes.

Figure 5-1. Plan Update and Permitting Process

	County	State	Local	F A C I L I T Y
New Facility	Plan Approval	UPDES Permit/ Construction Permit	Siting/Land Use	
Upgrade/ Expansion		Construction Permit		
Scalping	Plan Approval	Construction/Reuse Permit Groundwater Permit	Siting/Land Use	
Industrial	Plan Approval ?	UPDES Permit/ Construction Permit	Siting/Land Use	

Source: 2009 Plan

Based on information gathered and analysis provided in this 2015 Plan, there are currently two projects that could require a plan amendment:

- Feasibility study conducted by Salt Lake City Public Utilities to provide wastewater collection and treatment for land-development activities in the northwest quadrant of Salt Lake City.
- Planning activities conducted by Emigration Improvement District for wastewater collection and treatment associated with the bacteria impairment of Emigration Creek and implementation of the creek’s TMDL.

Other projects that could justify a plan amendment, if they advance, are land development by Rio Tinto on the county’s west side and regional transportation improvements in Parley’s Canyon and Big and Little Cottonwood Canyons associated with the Mountain Accord planning effort.

Required plan amendments would be prepared by the County, either directly or indirectly, through the project sponsor. Approval of the plan amendment would include Salt Lake County Council resolution and approval by the Utah governor and EPA.

5.9 References

[EPA] U.S. Environmental Protection Agency

2010 Letter to Gary Herbert. November 2.

Hunstman, Jon M., Jr.

2009 Letter to Carol Rushing, Acting Regional Administrator, U.S. Environmental Protection Agency. 2009 Salt Lake Countywide Water Quality Stewardship Plan. May 4.

[SLCO] Salt Lake County

2008 Resolution 4195. Salt Lake Countywide Water Quality Stewardship Plan (WaQSP). October 21.

2009 Salt Lake Countywide Water Quality Stewardship Plan.

2010 Stream Function Index. Addendum to 2009 Salt Lake Countywide Water Quality Stewardship Plan. April.

2015 Salt Lake County Watershed Public Opinion Survey Report of Findings. OpinionWorks. January.

This page is intentionally blank.